



MB39C831-EVB-02

# Thermal Energy Harvesting Evaluation Board Operation Guide

Doc. No. 002-08635 Rev. \*A

Cypress Semiconductor  
198 Champion Court  
San Jose, CA 95134-1709  
<http://www.cypress.com>

**Copyrights**

© Cypress Semiconductor Corporation, 2015-2016. The information contained herein is subject to change without notice. Cypress Semiconductor Corporation assumes no responsibility for the use of any circuitry other than circuitry embodied in a Cypress product. Nor does it convey or imply any license under patent or other rights. Cypress products are not warranted nor intended to be used for medical, life support, life saving, critical control or safety applications, unless pursuant to an express written agreement with Cypress. Furthermore, Cypress does not authorize its products for use as critical components in life-support systems where a malfunction or failure may reasonably be expected to result in significant injury to the user. The inclusion of Cypress products in life-support systems application implies that the manufacturer assumes all risk of such use and in doing so indemnifies Cypress against all charges.

**Trademarks**

All other trademarks or registered trademarks referenced herein are property of the respective corporations.

**Source Code**

Any Source Code (software and/or firmware) is owned by Cypress Semiconductor Corporation (Cypress) and is protected by and subject to worldwide patent protection (United States and foreign), United States copyright laws and international treaty provisions. Cypress hereby grants to licensee a personal, non-exclusive, non-transferable license to copy, use, modify, create derivative works of, and compile the Cypress Source Code and derivative works for the sole purpose of creating custom software and or firmware in support of licensee product to be used only in conjunction with a Cypress integrated circuit as specified in the applicable agreement. Any reproduction, modification, translation, compilation, or representation of this Source Code except as specified above is prohibited without the express written permission of Cypress.

**Disclaimer**

CYPRESS MAKES NO WARRANTY OF ANY KIND, EXPRESS OR IMPLIED, WITH REGARD TO THIS MATERIAL, INCLUDING, BUT NOT LIMITED TO, THE IMPLIED WARRANTIES OF MERCHANTABILITY AND FITNESS FOR A PARTICULAR PURPOSE. Cypress reserves the right to make changes without further notice to the materials described herein. Cypress does not assume any liability arising out of the application or use of any product or circuit described herein. Cypress does not authorize its products for use as critical components in life-support systems where a malfunction or failure may reasonably be expected to result in significant injury to the user. The inclusion of Cypress' product in a life-support systems application implies that the manufacturer assumes all risk of such use and in doing so indemnifies Cypress against all charges.

Use may be limited by and subject to the applicable Cypress software license agreement.

# Preface



This manual explains how to use the evaluation board. Be sure to read this manual before using the product. For this product, please consult with sales representatives or support representatives.

## **Handling and use**

Handling and use of this product and notes regarding its safe use are described in the manuals.

Follow the instructions in the manuals to use this product.

Keep this manual at hand so that you can refer to it anytime during use of this product.

## **Notice on this document**

All information included in this document is current as of the date it is issued. Such information is subject to change without any prior notice.

Please confirm the latest relevant information with the sales representatives.

# Cautions



## Caution of the products described in this document

The following precautions apply to the product described in this manual.

 <b>WARNING</b>	Indicates a potentially hazardous situation which could result in death or serious injury and/or a fault in the user's system if the product is not used correctly.
--	---

<b>Electric shock, Damage</b>	Before performing any operation described in this manual, turn off all the power supplies to the system. Performing such an operation with the power on may cause an electric shock or device fault.
<b>Electric shock, Damage</b>	Once the product has been turned on, do not touch any metal part of it. Doing so may cause an electric shock or device fault.

 <b>CAUTION</b>	Indicates the presence of a hazard that may cause a minor or moderate injury, damages to this product or devices connected to it, or may cause to lose software resources and other properties such as data, if the device is not used appropriately.
--	---

<b>Cuts, Damage</b>	Before moving the product, be sure to turn off all the power supplies and unplug the cables. Watch your step when carrying the product. Do not use the product in an unstable location such as a place exposed to strong vibration or a sloping surface. Doing so may cause the product to fall, resulting in an injury or fault.
<b>Cuts</b>	The product contains sharp edges that are left unavoidably exposed, such as jumper plugs. Handle the product with due care not to get injured with such pointed parts.
<b>Damage</b>	Do not place anything on the product or expose the product to physical shocks. Do not carry the product after the power has been turned on. Doing so may cause a malfunction due to overloading or shock.
<b>Damage</b>	Since the product contains many electronic components, keep it away from direct sunlight, high temperature, and high humidity to prevent condensation. Do not use or store the product where it is exposed to much dust or a strong magnetic or electric field for an extended period of time. Inappropriate operating or storage environments may cause a fault.
<b>Damage</b>	Use the product within the ranges given in the specifications. Operation over the specified ranges may cause a fault.
<b>Damage</b>	To prevent electrostatic breakdown, do not let your finger or other object come into contact with the metal parts of any of the connectors. Before handling the product, touch a metal object (such as a door knob) to discharge any static electricity from your body.

<b>Damage</b>	When turning the power on or off, follow the relevant procedure as described in this document. Before turning the power on, in particular, be sure to finish making all the required connections. Furthermore, be sure to configure and use the product by following the instructions given in this document. Using the product incorrectly or inappropriately may cause a fault.
<b>Damage</b>	Always turn the power off before connecting or disconnecting any cables from the product. When unplugging a cable, unplug the cable by holding the connector part without pulling on the cable itself. Pulling the cable itself or bending it may expose or disconnect the cable core, resulting in a fault.
<b>Damage</b>	Because the product has no casing, it is recommended that it be stored in the original packaging. Transporting the product may cause a damage or fault. Therefore, keep the packaging materials and use them when re-shipping the product.

# Contents



<b>1. Evaluation Board Specification</b> .....	<b>7</b>
<b>2. Block Diagram</b> .....	<b>8</b>
<b>3. PIN Descriptions</b> .....	<b>9</b>
3.1 Input/OutputPin Descriptions .....	9
3.2 Jumper, Switch Descriptions .....	10
<b>4. Setup and Verification</b> .....	<b>11</b>
4.1 Constant Mode .....	11
4.2 Charge Mode (MPPT Mode).....	13
<b>5. Layout</b> .....	<b>16</b>
5.1 Component Layout .....	16
<b>6. Circuit</b> .....	<b>20</b>
<b>7. Component List</b> .....	<b>21</b>
<b>8. Application Notes</b> .....	<b>23</b>
8.1 Harvester .....	23
8.2 Power Requirement in Start-Up in Constant Voltage Mode .....	23
8.3 Waveform of VDD/VOUT Voltages in Start-up in Constant Voltage Mode .....	24
<b>9. EVB Picture</b> .....	<b>25</b>
<b>10. Ordering Information</b> .....	<b>27</b>
<b>Revision History</b> .....	<b>28</b>
Document Revision History .....	28

# 1. Evaluation Board Specification



The MB39C831-EVB-02 is the evaluation board for the energy harvesting IC, MB39C831. This evaluation board is capable of accepting solar or thermal electric power source.

Table 1-1. Evaluation Board Specification

Parameter	Symbol	Condition	Min	Typ	Max	Unit
Input voltage	VDD	-	0.3	-	4.75	V
Input current	VDD	-	0.75	-	5(*1)	mA
Output voltage	VOUT	See Table4-3	3.0	-	5	V
Output current	VOUT	VDD=0.6V, VOOUT=3.3V	8	-	-	mA
		VDD=3.0V, VOOUT=3.3V	80	-	-	mA
		VDD=3.1V, VOOUT=3.3V VDD=3.4V, VOOUT=3.6V VDD=3.9V, VOOUT=4.1V	-	-	240(*1)	mA

\*1: This parameter is not be specified. This should be used as a reference to support designing the circuits. Please see the MB39C831 datasheet (DS405-00014) for more information.

Board size: 80mm × 80mm, Layer: 4-layer board

# 2. Block Diagram



Figure 2-1. Block Diagram

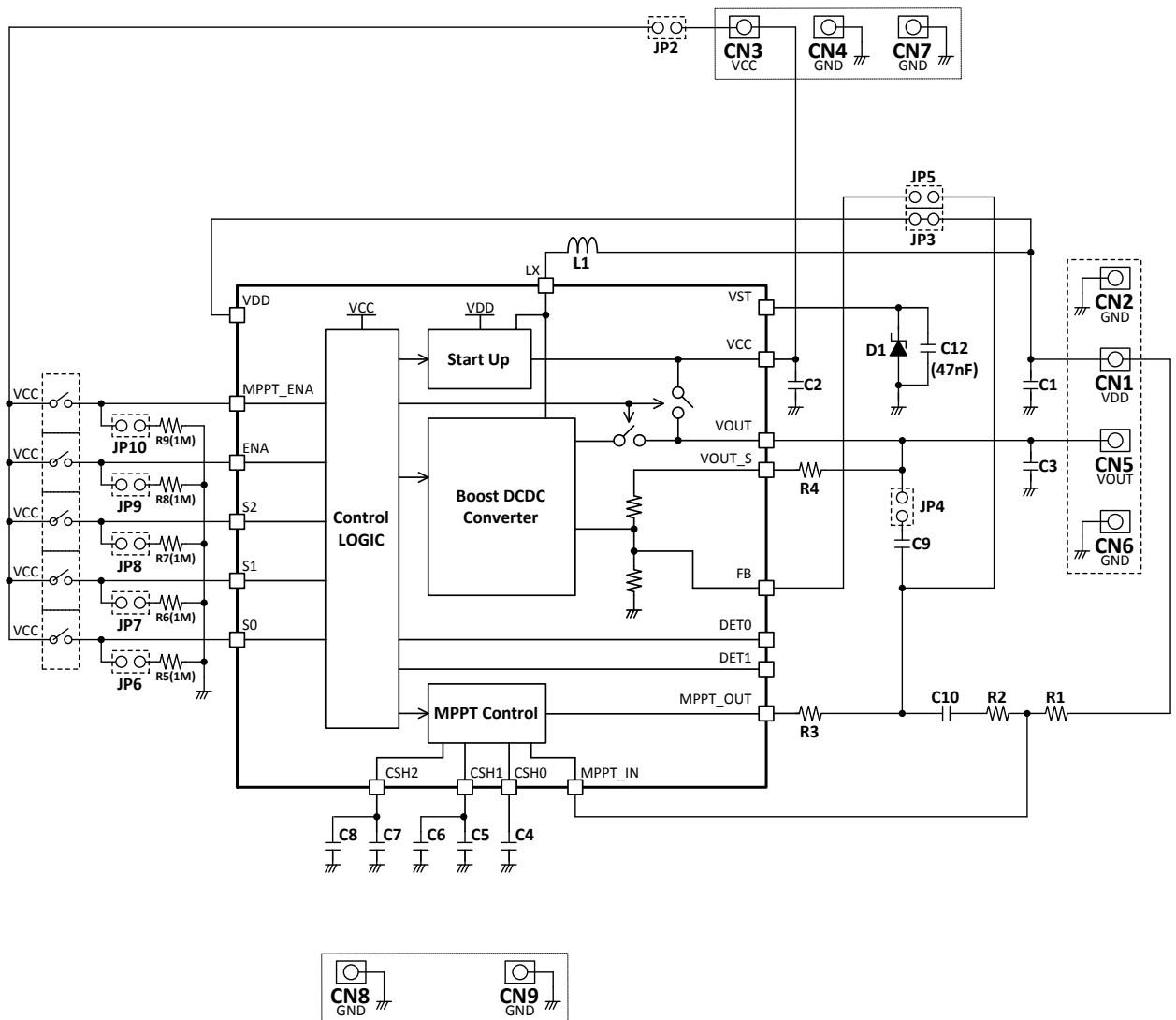



# 3. PIN Descriptions



## 3.1 Input/Output Pin Descriptions

Table 3-1. Input/Output Pin Descriptions

Pin No.	Pin Name	I/O	Description
CN1	VDD	I	Outside power input pin
TP1	VDD_S	I	VDD sense pin
TP2	VDD_F	I	VDD force pin
TP3	GND_S	-	GND pin for VDD sense pin
CN3	VCC	O	Power output pin for control
CN5	VOUT	O	DCDC converter output pin
TP5	VOUT_S	O	VOUT sense pin
TP6	VOUT_F	O	VOUT force pin
TP7	GND_S	-	GND pin for VOUT sense pin
TP9	VST	O	Start-up power output pin
TP10	DET0	O	Status notification output pin
TP11	DET1	O	Status notification output pin
TP17	S0	I	Preset voltage setting, or MPPT setting input
TP18	S1	I	Preset voltage setting, or MPPT setting input
TP19	S2	I	Preset voltage setting, or MPPT setting input
TP20	ENA	I	DCDC converter control input pin
TP21	MPPT_ENA	I	MPPT control input pin
CN2, CN4, CN6, CN7, CN8, CN9, TP4, TP8	GND	-	GND pins

## 3.2 Jumper, Switch Descriptions

Table 3-2. Jumper, Switch Descriptions

Jumper	Description	Initial Setting	
		Constant Mode	Charge Mode
JP2	Pull-up resistance setting for SW1-1 - SW1-5	Short	Short
JP3	Loop setting for VDD pin and LX pin	Short	Short
JP4	To connect VOUT pin and C9 capacitor	Open	Short
JP5	To connect FB pin and MPPT_OUT pin	Open	Short
JP6	Pull-up resistance setting for S0 pin	Short	Short
JP7	Pull-up resistance setting for S1 pin	Short	Short
JP8	Pull-up resistance setting for S2 pin	Short	Short
JP9	To connect ENA pin and Pull-down resistance	Open	Open
JP10	To connect MPPT_ENA pin and Pull-down resistance	Short	Open
SW1-1	Pull-down /Pull-up setting for S0 pin	Off (S0=L)	Off (S0=L)
SW1-2	Pull-down /Pull-up setting for S1 pin	Off (S1=L)	Off (S1=L)
SW1-3	Pull-down /Pull-up setting for S2 pin	Off (S2=L)	Off (S2=L)
SW1-4	Pull-down /Pull-up setting for ENA pin	On (ENA=H)	On (ENA=H)
SW1-5	Pull-down /Pull-up setting for MPPT_ENA pin	Off (MPPT_ENA=L)	On (MPPT_ENA=H)

Table 3-3. Preset Output Voltage Settings of Constant Mode

MPPT_ENA	S2 (SW001)	S1 (SW002)	S0 (SW003)	Preset Output Voltage[V]
L	L	L	L	3.0 (Initial Setting)
L	L	L	H	3.3
L	L	H	L	3.6
L	L	H	H	4.1
L	H	L	L	4.5
L	H	L	H	5.0

Table 3-4. MPPT Settings of Charge Mode

MPPT_ENA	S2 (SW001)	S1 (SW002)	S0 (SW003)	MPPT Setting [%]
H	L	L	L	50 (Initial Setting)
H	L	L	H	55
H	L	H	L	60
H	L	H	H	65
H	H	L	L	70
H	H	L	H	75
H	H	H	L	80
H	H	H	H	85

# 4. Setup and Verification



## 4.1 Constant Mode

1. Set the DIP switches and the jumper pins as shown in the Figure 4-1 and the Table 4-1 (see the Table 4-2 for the initial settings of the constant mode).
2. Input a DC voltage into CN1 (VDD). In order to startup the boost converter, the starting power is required as shown in the section 9.2. Input enough power into CN1 (VDD).
3. 3V is output to CN5 (VOUT).
4. To change the output voltage, change the switch settings (see the Table 4-2).



Table 4-2. Preset Output Voltage Settings of Constant Mode

S2		S1		S0		Preset Output Voltage[V]
SW1-3	JP8	SW1-2	JP7	SW1-1	JP6	
Off	Short	Off	Short	Off	Short	3.0 (Initial Setting)
Off	Short	Off	Short	On	Open	3.3
Off	Short	On	Open	Off	Short	3.6
Off	Short	On	Open	On	Open	4.1
On	Open	Off	Short	Off	Short	4.5
On	Open	Off	Short	On	Open	5.0
On	Open	On	Open	Off	Short	Forbidden
On	Open	On	Open	On	Open	Forbidden

## 4.2 Charge Mode (MPPT Mode)

1. Set the DIP switches and the jumper pins as shown in the Figure 4-2 (see the Table 4-3) for the initial settings of the charge mode).
2. Connect a Li-ion battery not lower than 2.6V to CN5 (VOUT).
3. Input a DC voltage into CN1 (VDD). See the "Example for the input voltage calculation".
4. Charging is started to the Li-ion battery. The battery is charged between 2.6V and 4V, when the battery reaches 4V, charge is stopped.
5. To change the MPPT setting, change the switch settings (see the Table 4-4)

Example for the input voltage calculation

Release voltage of solar cell: 1[V]

MPPT setting: 50 [%]

Input voltage (VDD) [V] =  $1[V] / (50/100) = 0.5[V]$

Figure 4-2. Charge Mode Setting (MPPT Mode Setting)

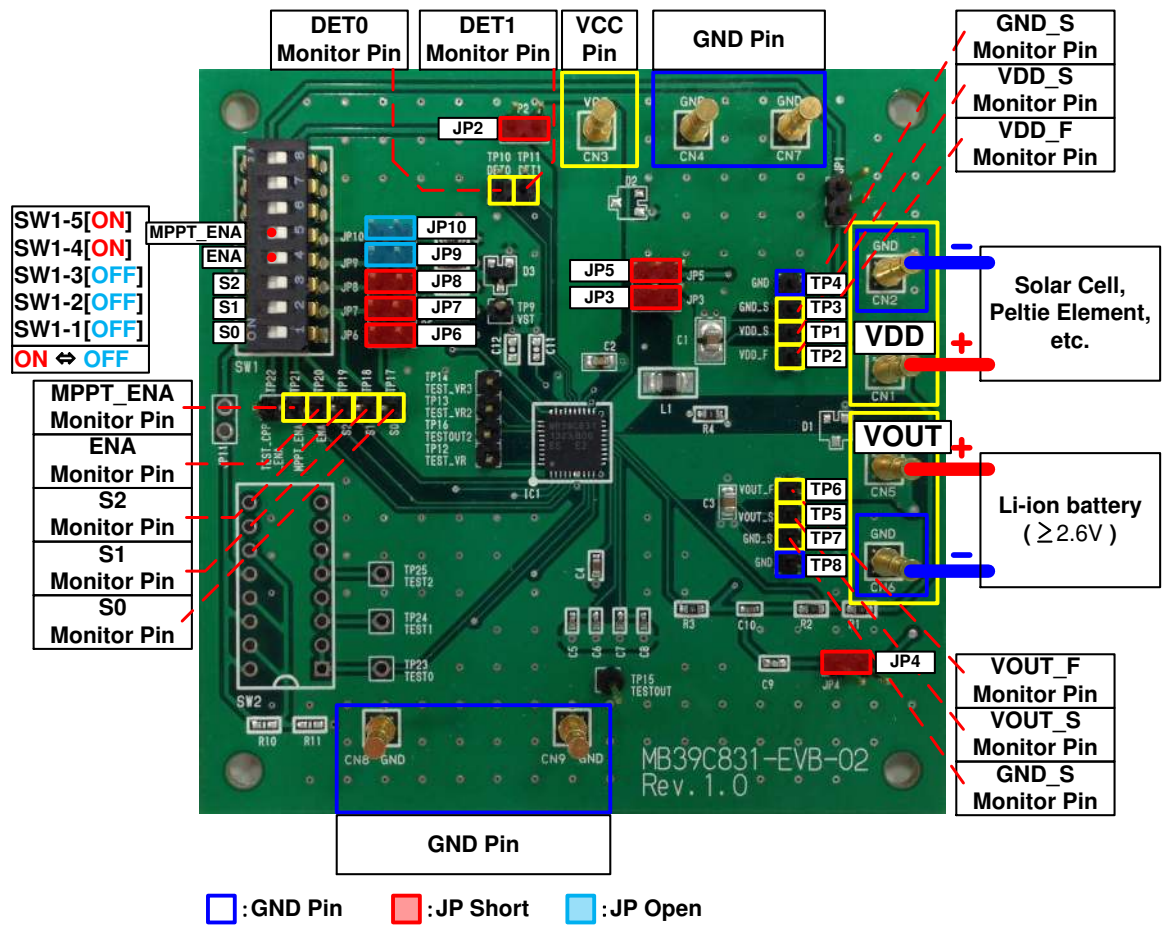

Table 4-3. MPPT\_ENA, ENA Settings of Charge Mode

MPPT_ENA		ENA		Status
SW1-5	JP10	SW1-4	JP9	
On	Open	Off	Short	Charging Mode, Disable
On	Open	On	Open	Charging Mode, Enable

Table 4-4. MPPT Settings of Charge Mode

S2		S1		S0		MPPT Values
SW1-3	JP8	SW1-2	JP7	SW1-1	JP6	
Off	Short	Off	Short	Off	Short	50% (Initial Setting)
Off	Short	Off	Short	On	Open	55%
Off	Short	On	Open	Off	Short	60%
Off	Short	On	Open	On	Open	65%
On	Open	Off	Short	Off	Short	70%
On	Open	Off	Short	On	Open	75%
On	Open	On	Open	Off	Short	80%
On	Open	On	Open	On	Open	85%

# 5. Layout



## 5.1 Component Layout

Figure 5-1. Component Layout (Layer 1)

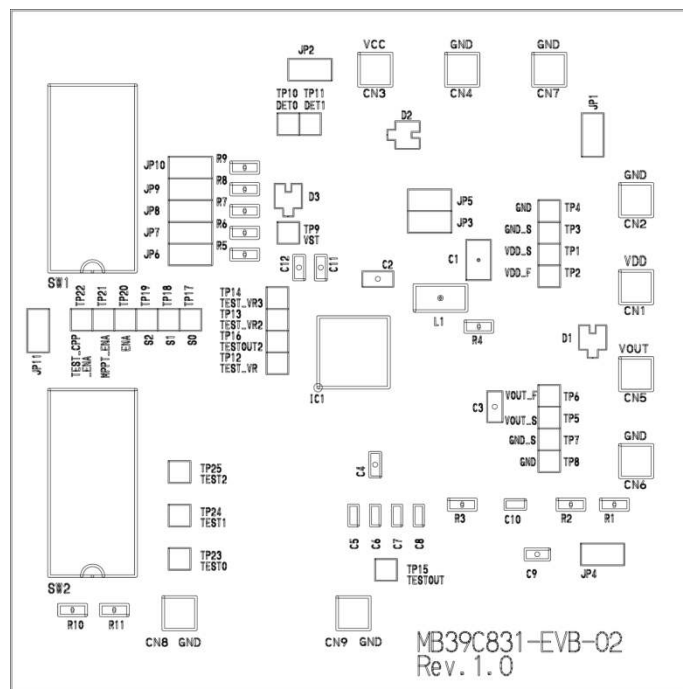
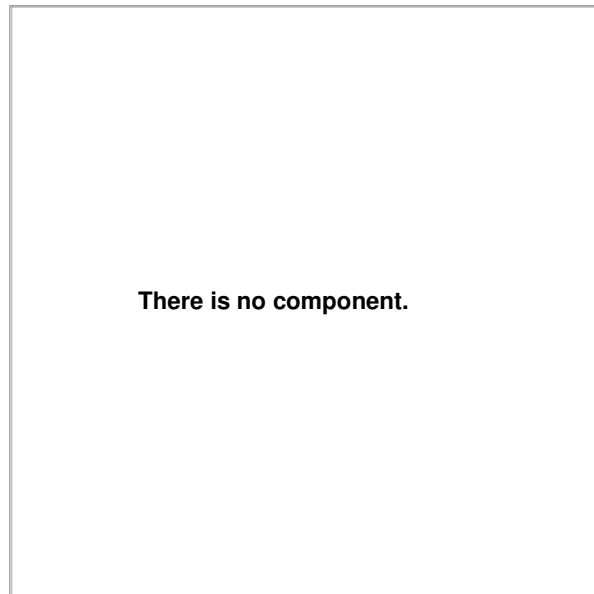



Figure 5-2. Component Layout (Layer 4)



## 5.2 Wiring Layout

Figure 5-3. Wiring Layout(Layer 1)

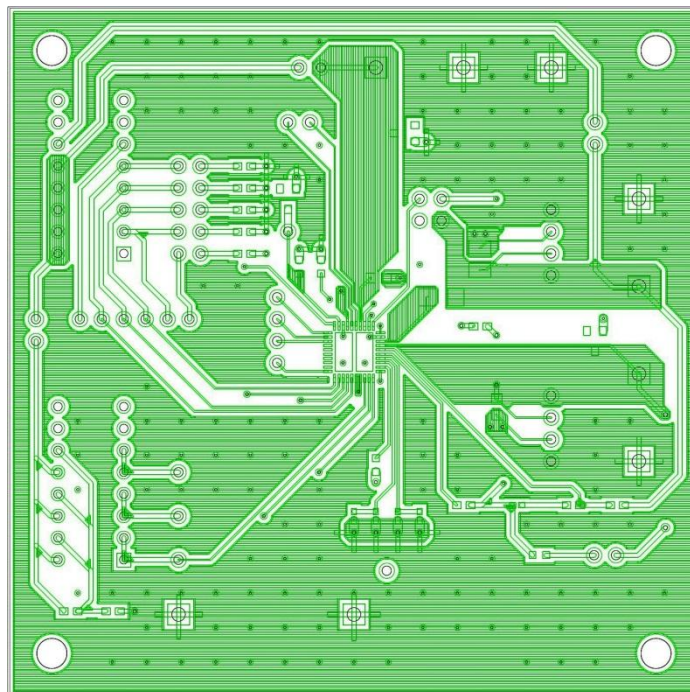

Figure 5-4. Wiring Layout (Layer 2)

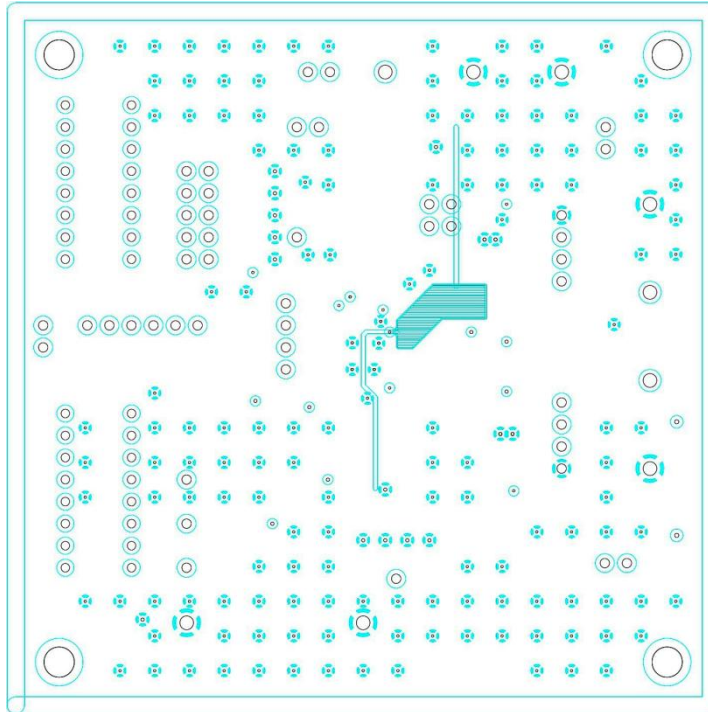

Figure 5-5. Wiring Layout (Layer 3)

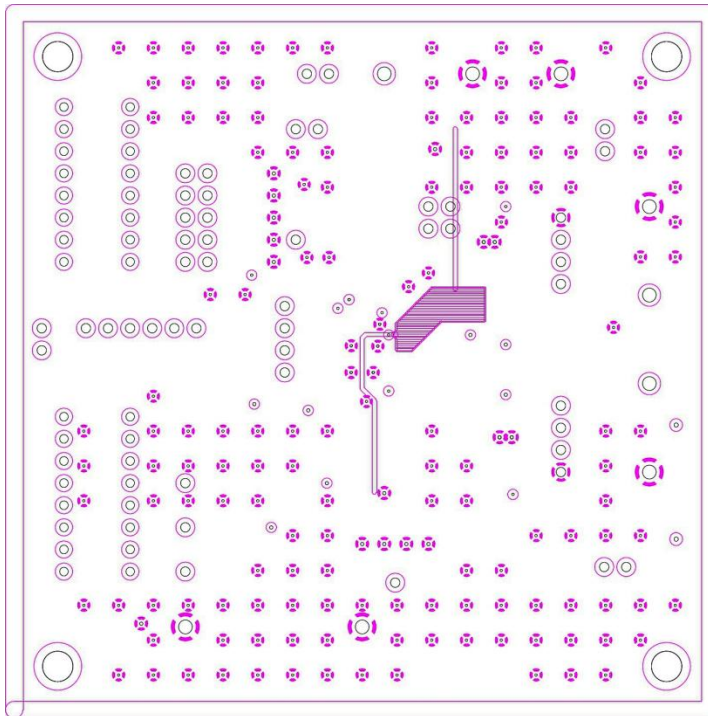
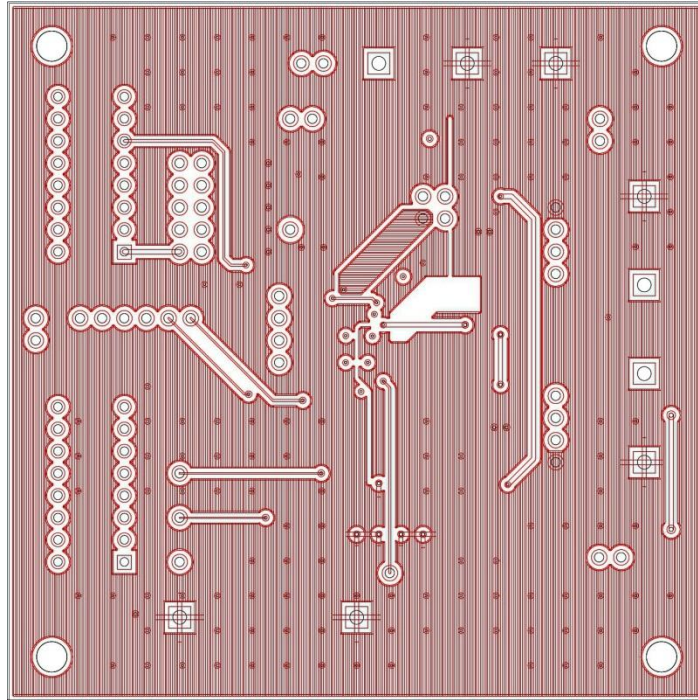

Figure 5-6. Wiring Layout (Layer 4)



# 6. Circuit



Figure 6-1. Circuit

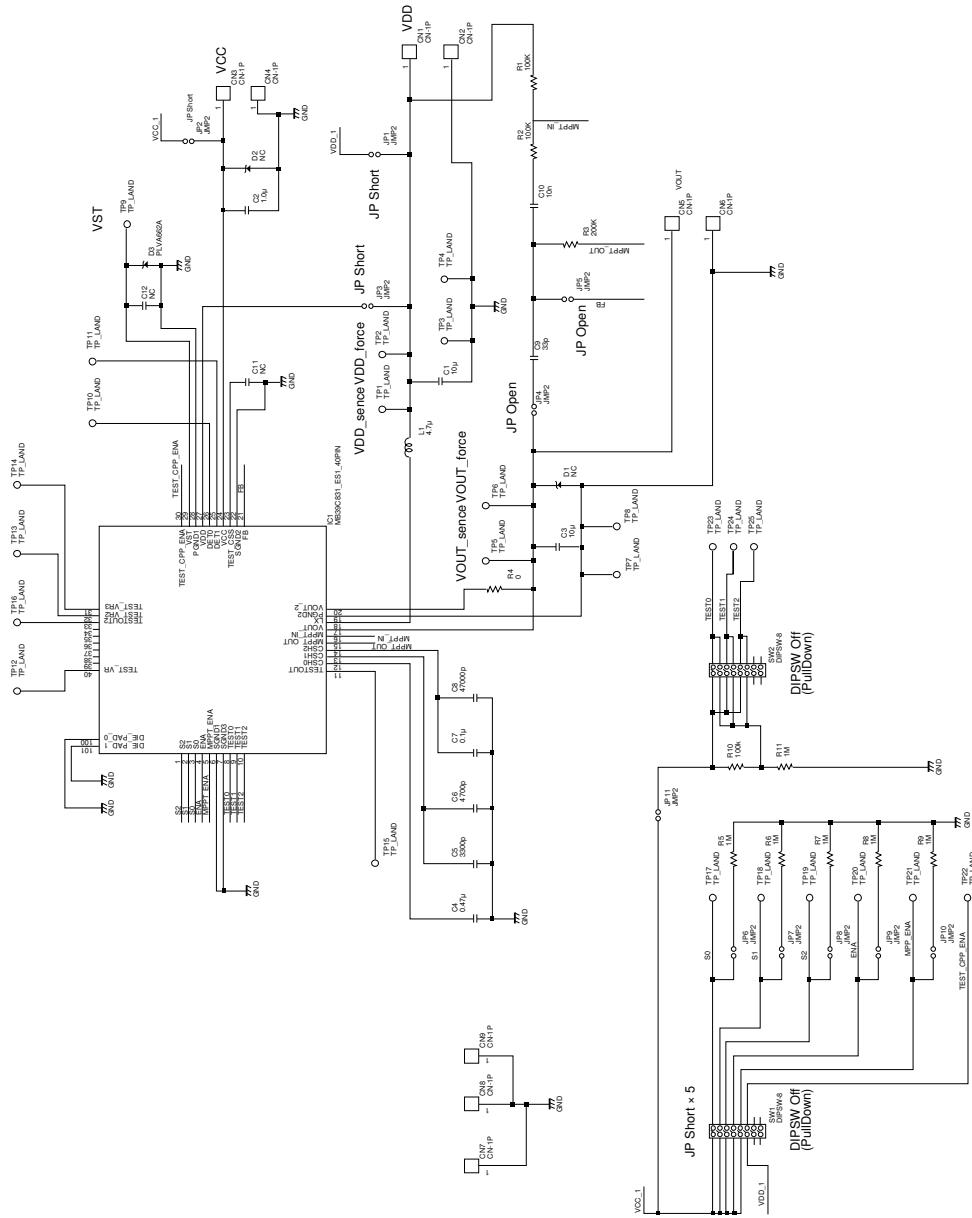

# 7. Component List



Table 7-1. Component List

No.	Comp. No.	Non-mounted	Vender	Class.	Part Number	Rating	Note
1	C1,C3		Murata	Capacitor	GRM21BR71A106K	10V	Land patterns are for 1608, 2012, 3225 size capacitor
2	C2		Murata	Capacitor	GRM188R71C105K	16V	
3	C4		Murata	Capacitor	GRM188R71A474K	10V	
4	C5		Murata	Capacitor	GRM155R71H332K	50V	
5	C6		Murata	Capacitor	GRM155R71H472K	50V	
6	C7		Murata	Capacitor	GRM155R71A104K	10V	
7	C8		Murata	Capacitor	GRM155R71A473K	10V	
8	C9		Murata	Capacitor	GRM1552C1H330J	50V	
9	C10		Murata	Capacitor	GRM155R71E103K	25V	
10	C11	N.M.	Murata	Capacitor	GRM155B11C223K	16V	Land pattern only
11	C12	N.M.	Murata	Capacitor	GRM188R71H473K	50V	Land pattern only
12	R1,R2		KOA	Resistor	RK73B1JTDD104J	0.1W	
13	R10	N.M.	KOA	Resistor	RK73B1JTDD104J	0.1W	Land pattern only
14	R3		KOA	Resistor	RK73B1JTDD204J	0.1W	
15	R4		KOA	Resistor	RK73Z1JT	1A	
16	R5,R6,R7, R8,R9		KOA	Resistor	RK73B1JTDD105J	0.1W	
17	R11	N.M.	KOA	Resistor	RK73B1JTDD105J	0.1W	Land pattern only
18	L1		TAIYO YUDEN	Inductor	CKP25204R7M-T	1.1A	
19	D1,D2	N.M.	NXP Semi.	Zener diode	PLVA662A	6.2V	Land pattern only
20	D3		NXP Semi.	Zener diode	PLVA662A	6.2V	SOT23 SMD
21	CN1 to CN9		Mac8	Terminal	WT-2-1	-	φ1.6

No.	Comp. No.	Non-mounted	Vender	Class.	Part Number	Rating	Note
22	JP1 to JP10		Linkman	Jumper	2130S1*40GSE	1A	2x1 pin header(2.54mm pitch)
23	JP11	N.M.	Linkman	Jumper	2130S1*40GSE	1A	Land pattern only
24	SW1		COPAL ELEC.	DIP switch	CFS-0800MC	-	
25	SW2	N.M.	COPAL ELEC.	DIP switch	CFS-0800MC	-	Land pattern only
26	TP1 to TP25		Linkman	Pin header	2130S1*40GSE	1A	1 pin header(2.54mm pitch)
27	IC1		Spansion	IC	MB39C831	23V	QFN40pin

These components are compliant with RoHS, but please ask each vender for details if necessary.

Murata: Murata Manufacturing Co., Ltd.

KOA: KOA Corporation

TAIYO YUDEN: TAIYO YUDEN CO., LTD.

NXP Semi: NXP Semiconductors

Mac8: Mac-Eight Co., Ltd.

Linkman: Linkman Co., Ltd.

COPAL ELEC.: NIDEC COPAL ELECTRONICS CORPORATION

# 8. Application Notes



## 8.1 Harvester

The MB39C831 is designed for a harvester having a high power generation capacity, such as an outdoor solar cell. It is not possible to start up with a small indoor solar cell.

## 8.2 Power Requirement in Start-Up in Constant Voltage Mode

The VDD (VDD=0.35V) voltage is applied from constant voltage source.

Table 8-1. Power Requirement in Start-Up

Preset Output Voltage Setting [V]	Average Voltage in Start-Up at VDD [V]	Current Requirement in Start-Up at VDD [mA]	Power Requirement in Start-Up at VDD [mW]
3.0	0.35	17.7	6.20
3.3	0.35	18.8	6.58
3.6	0.35	22.7	7.95
4.1	0.35	33.1	11.59
4.5	0.35	46.3	16.21
5.0	0.35	73.6	25.76

VDD voltage is applied from constant voltage source.

Figure 8-1. Current and Power Requirements in Start-Up

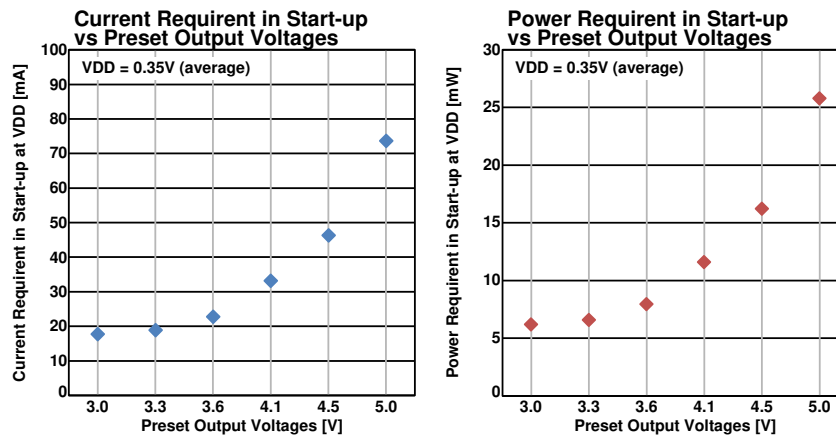

VDD voltage is applied from constant voltage source

### 8.3 Waveform of VDD/VOUT Voltages in Start-up in Constant Voltage Mode

The followings are the waveform of the VDD/VOUT voltages in start-up when a solar cell is connected.

Figure 8-2. Waveform of VDD/VOUT Voltage in Start-up

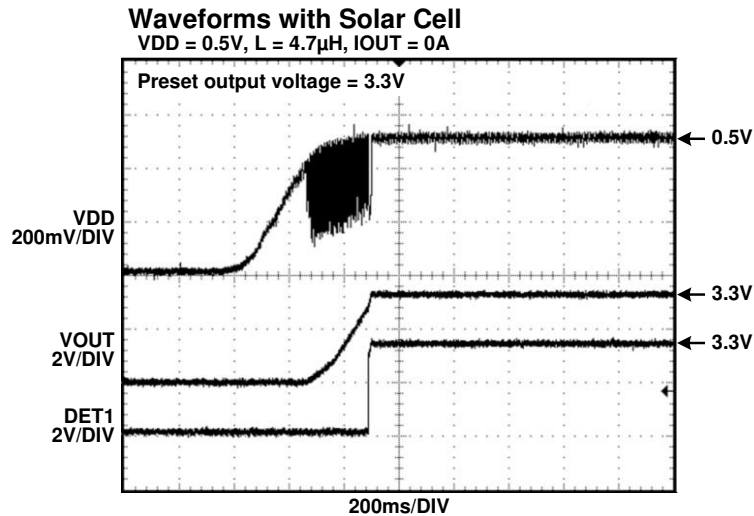

The current requirements in start-up are shown in Table9-2 when the VDD current is applied from constant current source (because a solar cell operates close to a constant current source). For each preset output voltage, select a right harvester to satisfy the following current value in start-up.

Table 8-2. Current Requirement in Start-Up at VDD

Preset Output Voltage[V]	Current Requirement in Start-Up at VDD[mA]
3.0	8.4
3.3	23.8
3.6	42.2
4.1	51.9
4.5	63.6
5.0	87.9

VDD current is applied from constant current source.



# 9. EVB Picture



Figure 9-1. EVB Picture (Top)

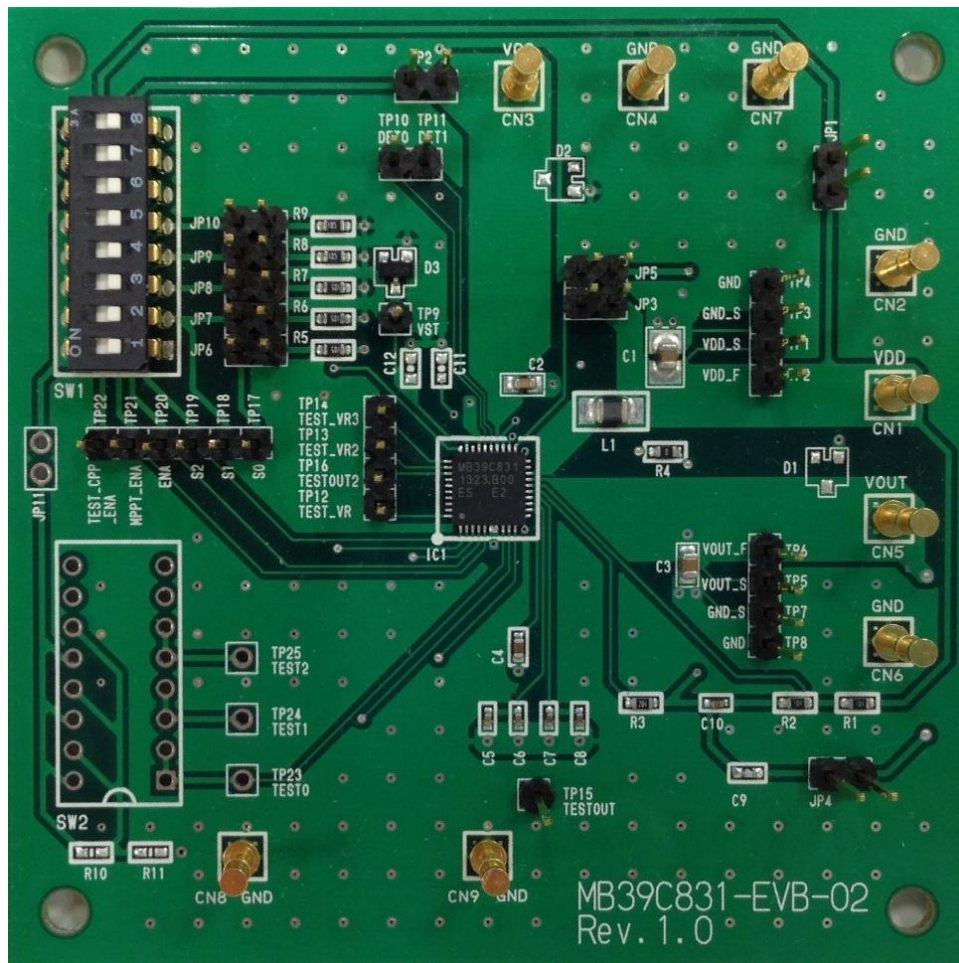
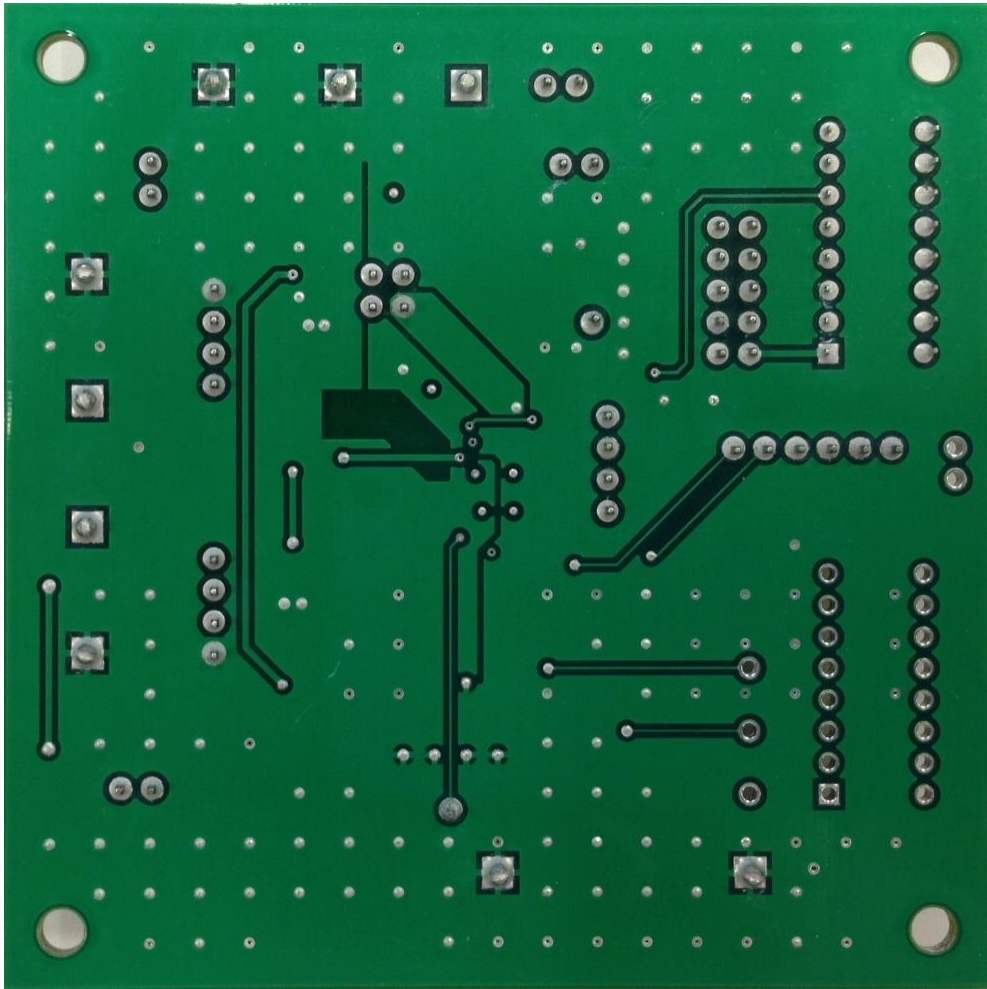

Figure 9-2. EVB Picture (Back)



# 10. Ordering Information



Table 10-1. Ordering Information

Part Number	EVB Revision	Note
MB39C831-EVB-02	Rev 1.0	---

# Revision History



## Document Revision History

Document Title: MB39C831-EVB-02 Thermal Energy Harvesting Evaluation Board Operation Guide			
Document Number: 002-08635			
Revision	Issue Date	Origin of Change	Description of Change
**	02/13/2015	EIFU	<b>Revision 01:</b> Initial release
			<b>Revision 02:</b> Section1 "Description" Deleted "Capable of accepting any high impedance DC source"
			<b>Revision 03:</b> Section 2 "Evaluation Board Specification" Table 2-1 Evaluation Board Specification Added the Max values of the output current
			Section 5 "Setup and verification and 5.2 Charge mode (MPPT mode)" Table 5-4 MPPT Settings of Charge Mode Corrected the contents of the MPPT Values
			Section 8 "Component List" Table 8-1 Component List Added the vender's official names
*A	02/05/2016	EIFU	Migrated Spansion Guide from MB39C831-EVB-02_SS901-00018-3v0-E to Cypress format