

PIC-USB-STK development board

Users Manual



All boards produced by Olimex are ROHS compliant

Rev.A, March 2008

Copyright(c) 2008, OLIMEX Ltd, All rights reserved

INTRODUCTION:

PIC-USB-STK is starterkit which allow you to explore all capabilities of PIC18F4550 and the Microchip's USB firmware. The software examples include: USB HID mouse which allow you to move the mouse cursor with the four buttons on the board, USB Mass storage device on SD-MMC card simple adds USB disk to your computer, USB to RS232 converter all these firmware under your control and ready to be customized and embedded in your next application. The debugging is In-Circuit through ICSP connector, the free available ports are put on EXT connector.

BOARD FEATURES:

- CPU: PIC18F4550-I/P on DIL socket
- ICSP/ICD connector for programming with PIC-ICD2
- USB 2.0 type B connector allow board to be interfaced to PC host.
- RS232 connector
- SD-MMC connector
- Audio In, Audio Out connectors
- Status LEDs
- Trimmer potentiometer POT
- Four buttons
- Quartz crystal 20Mhz
- Reset button
- Power plug-in jack with diode bridge can be powered with AC or DC power supply
- 5V voltage regulator
- Extension slot for the not connected ports
- Four mounting holes 3,3 mm (0,13")
- FR-4, 1.5 mm (0,062"), green soldermask, white silkscreen component print
- Dimensions 104x76 mm (4,1x3")

ELECTROSTATIC WARNING:

The PIC-USB-STK board is shipped in protective anti-static packaging. The board must not be subject to high electrostatic potentials. General practice for working with static sensitive devices should be applied when working with this board.

BOARD USE REQUIREMENTS:

To use PIC-USB-STK you must have:

Cables: USB A-B 1.8 meter cable to connect with USB host.
RS232 straight female – male cable to connect with PC COM port.

Hardware: Programmer/debugger PIC-ICD2, PIC-ICD2-POCKET, PIC-ICD2-TINY, or other compatible tool like MPLAB-ICD2

!!!Warning!!! When you want to program this microcontroller with PIC-ICD2, PIC-ICD2-POCKET or PIC-ICD2-TINY, before connecting

the programmer to your target board, you should first connect the programmer to your computer and open MPLAB. There, first from menu Configure – Select Device – choose the microcontroller you are about to program, then from menu Programmer – Select Programmer – choose MPLAB ICD 2, wait while MPLAB is downloading operation system, and after ICD2 is connected – check in menu Programmer – Settings – Power – there is option – Power target circuit from MPLAB ICD 2 – this option should be forbidden, you could not select it. Now it is safe to connect the programmer to your target board.

Software: MPLAB IDE and C18 C compiler

BOARD LAYOUT:

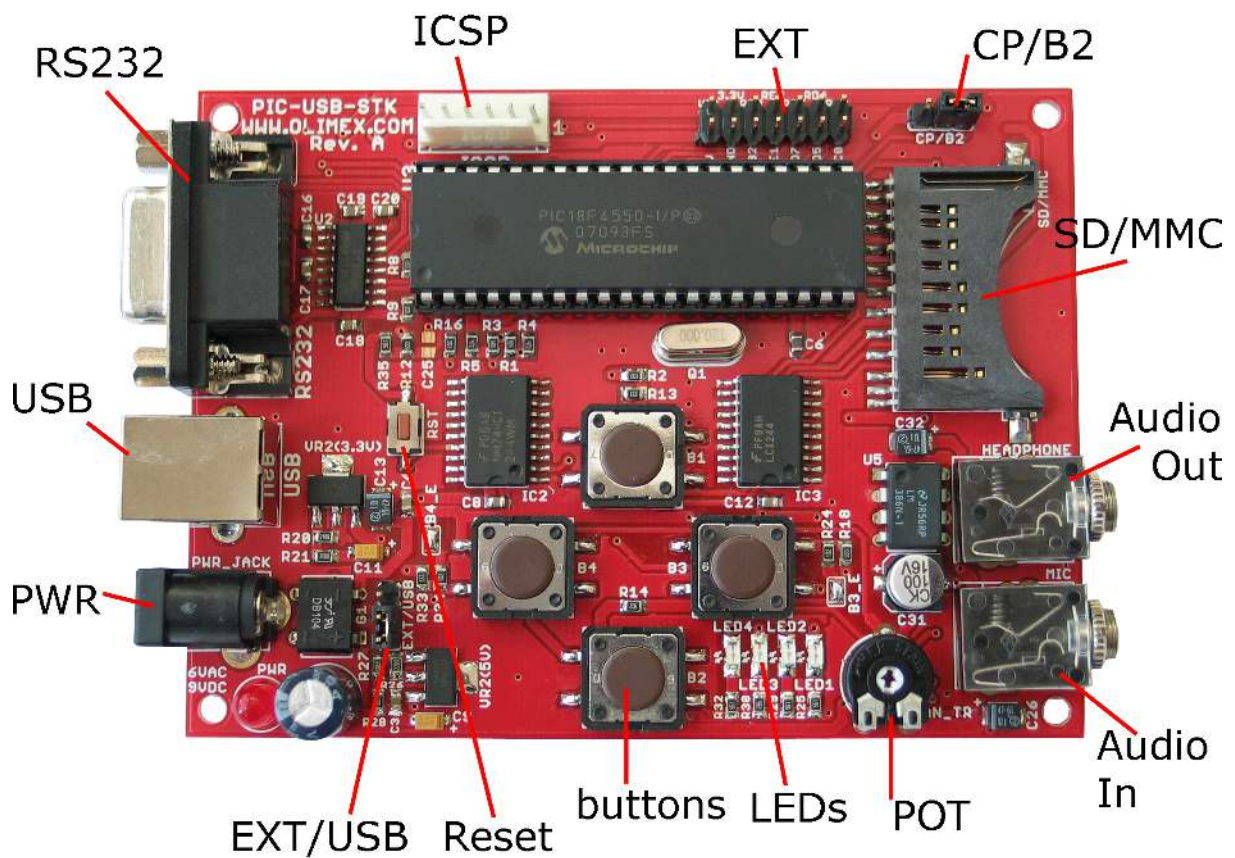

PROCESSOR FEATURES:

Here are listed **PIC18F4550** main features:

- CPU clock up to 48 MHz;
- FLASH 32 KBytes;
- RAM 2048 Bytes;
- EEPROM 256 Bytes;
- USB 2.0 Full Speed (12 Mb/s)
- 35 I/O ports;
- ADC 10 bit, 13 channels;
- SPI x1;
- I2C x1;
- UART x1;
- SPP x1;
- CCP/PWM x1;
- Comparators x2;
- Timers 8/16bit x1/3;
- power supply 2.0-5.5V;
- operating temperature -40C+85C;

Block diagram:

FIGURE 1-2: PIC18F4455/4550 (40/44-PIN) BLOCK DIAGRAM

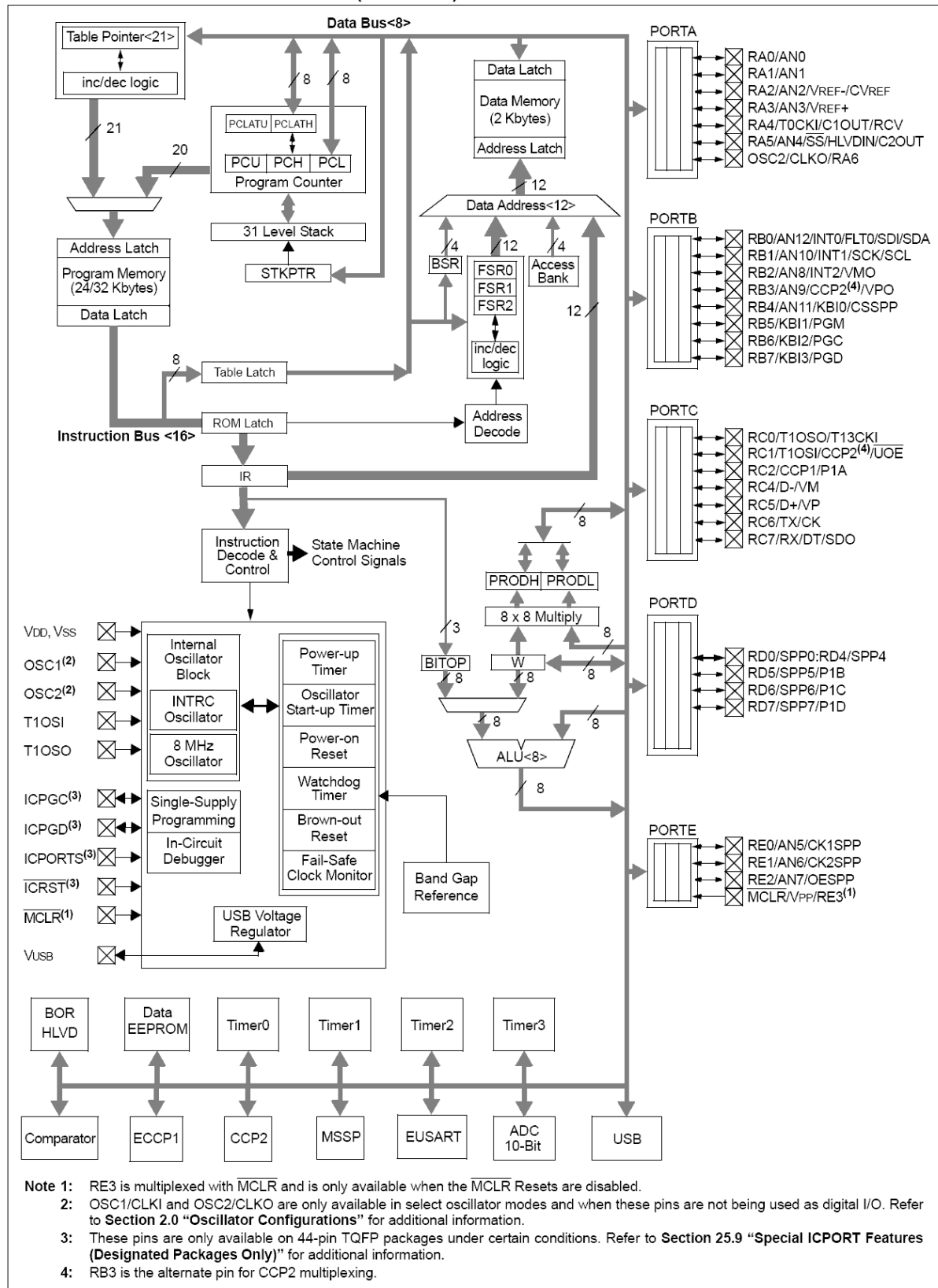

MEMORY MAP:

FIGURE 5-1: PROGRAM MEMORY MAP AND STACK FOR PIC18F2455/2550/4455/4550 DEVICES

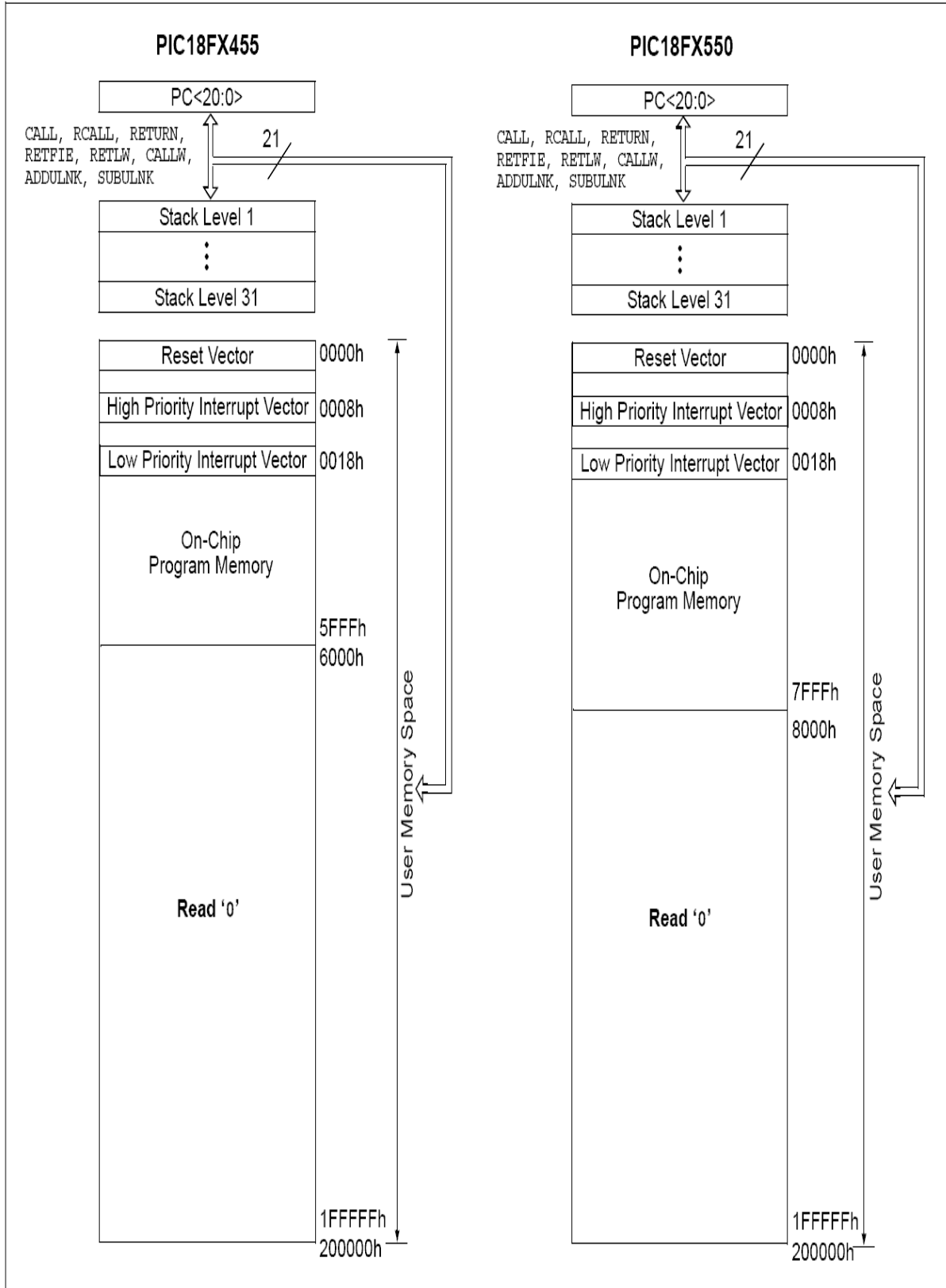

POWER SUPPLY CIRCUIT:

PIC-USB-STK is powered with +9VDC or 6VAC from PWR_JACK connector or from USB connector.

Current consumption from power supply is typical around 70mA with shipped PIC-USB-STK demo code.

RESET CIRCUIT:

PIC-USB-STK reset circuit is made with 10k pull-up resistor and RST button connected to GND.

CLOCK CIRCUIT:

Quartz crystal Q1-20Mhz is connected to PIC18F4550 OSC1 and OSC2 pins.

JUMPER DESCRIPTION:

SMD jumper description

B4_E The B4_E jumper connects Button 4 with PB6/PGC pin of PIC18F4550. In debug mode please do not press Button 4 as this will corrupt ProgramClock PB6 line and the result will be not predictable

Default state - closed  i.e. Button 4 is enabled

B3_E The B3_E jumper connects Button 3 with PB7/PGD pin of PIC18F4550. In debug mode please do not press Button 3 as this will corrupt ProgramData PB7 and the result will be not predictable.

Default state - closed  i.e. Button 3 is enabled

PTH jumper description:

EXT/USB The EXTernal/USB jumper defines the power source which supply the board.

EXT position – The board is supplied from PWR_JACK(6VAC or 9VDC).

USB position – The board is supplied from USB type B connector.

Default state

EXT



CP/B2

CP position – Card Present pin of SD/MMC socket is connected to PB4(pin37)

B2 position – Button 2 is connected to PB4(pin37).

Button 2 is used for boot mode entry. If CP/B2 jumper is in B2 state and B2 is pressed at power up, the board enters in boot mode.

Default state

B2



INPUT/OUTPUT:

Trimmer pot:	Trimmer potentiometer 10K connected to RA0/AN0
Buttons:	four user buttons are available: Button1 connected to RB5 with pullup, when the button is pressed the RB5 is read as 0, otherwise as 1 Button2 connected to RB4 with pullup, when the button is pressed the RB4 is read as 0, otherwise as 1 Button3 connected to RB7 via B3_E SMD jumper with pullup, when the button is pressed RB7 is read as 0, otherwise as 1 Button4 connected to RB6 via B4_E SMD jumper with pullup, when the button is pressed RB6 is read as 0, otherwise as 1 Please do not press Button3, Button4 during debug as they share PGC PGD microcontroller ports which are used for programming/debugging.
LEDs:	four LEDs are available: LED1 connected to RD0, logic 1 turn LED ON, logic 0 turn LED OFF LED2 connected to RD1, logic 1 turn LED ON, logic 0 turn LED OFF LED3 connected to RD2, logic 1 turn LED ON, logic 0 turn LED OFF LED4 connected to RD3, logic 1 turn LED ON, logic 0 turn LED OFF
AUDIO:	MIC input connected to RA5/AN4 ADC input via pre-amplifier, can take signal from external microphone. HEADPHONE output from RC1 output via power amplifier LM386 can drive headphones.

EXTERNAL CONNECTOR DESCRIPTION:

PWR JACK:

Pin #	Signal Name
1	Power Input
2	GND

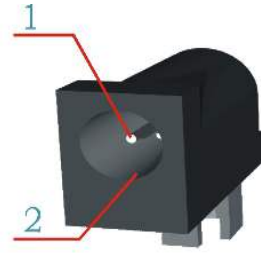

Polarity doesn't matter as there is diode bridge.

USB:

Pin #	Signal Name
1	+5V_USB
2	D-
3	D+
4	GND

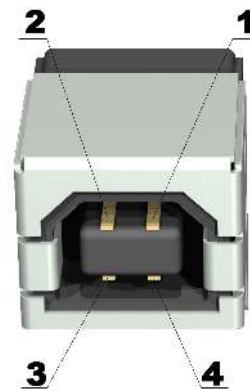

This is standard USB Type B connector.

RS232:

Pin #	Signal Name
1	Not Connected
2	TX0OUT
3	RX0IN
4	Not Connected
5	GND
6	Not Connected
7	Connected to R2IN
8	Connected to T2OUT
9	Not Connected

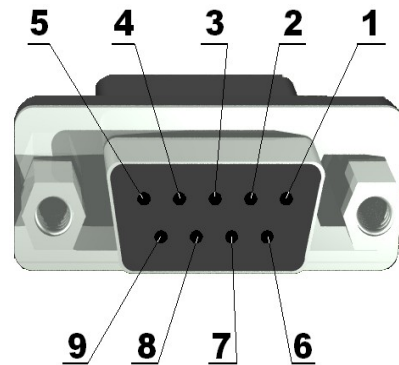

This is standard DB9 RS232 female type connector.

HEADPHONE:

Pin #	Signal Name
1-L	Audio Left OUT
2-C	GND
3-R	Audio Right OUT

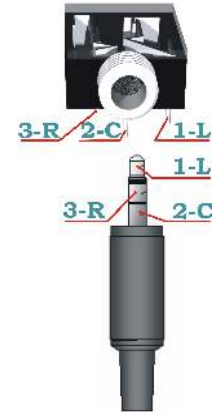

This is 3.5 mm Audio jack female connector and work with most standard 3.5 mm jack headphones. Note the signal is Mono i.e. Left and Right channel info is same.

MIC:

Pin #	Signal Name
1-L	Audio Left IN
2-C	GND
3-R	Audio Right IN

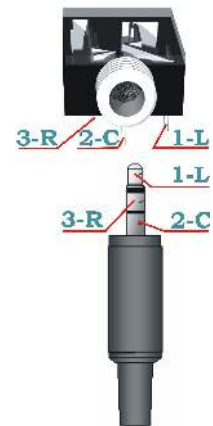

This is standard 3.5 mm Audio jack female connector.

Note the signal is Mono i.e. Left and Right channels are connected together.

SD/MMC:

Pin #	Signal Name	Pin #	Signal Name
1	CS_	9	Pull-up to 3.3V
2	SDO_	10	WP
3	GND	11	Not Connected
4	VDD	12	Not Connected
5	SCK_	13	CP
6	GND	14	Pull-down
7	SDI_	15	Pull-down
8	Pull-up to 3.3V		

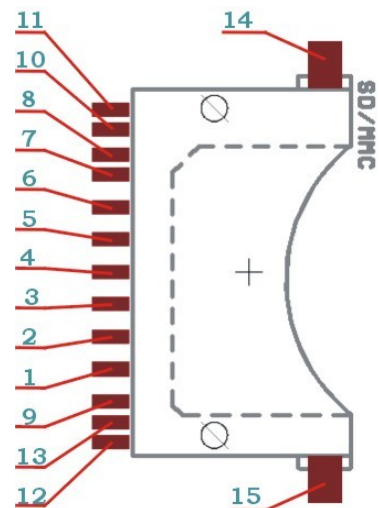

This is standard SD-MMC card connector,

ICSP:

Pin #	Signal Name
1	Reset
2	+5V
3	GND
4	PGD
5	PGC
6	Not Connected

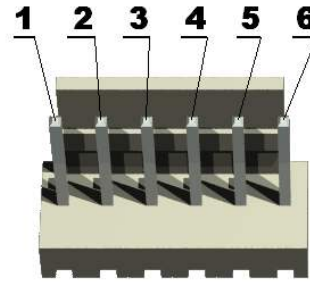

This is standard ICSP connector used in all Olimex's board. The connector is CI33 type made by Cvilux Inc. Taiwan. If you are not using Olimex ICD2 but Microchip you will need PIC-ICSP cross-cable

Extension:

Pin #	Signal Name
1	5V
2	VIN
3	GND
4	3.3V
5	RB2
6	RE0
7	RE1
8	RE2
9	RD7
10	RD6
11	RD5
12	RD4
13	RC0
14	RC2

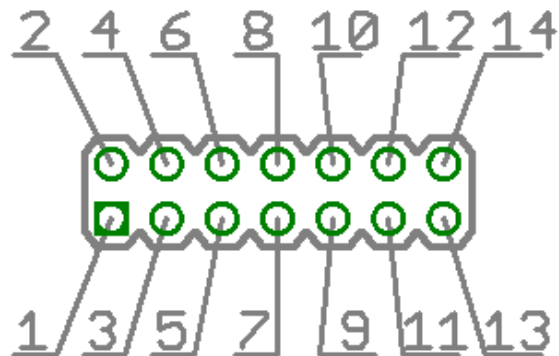

This is standard 0.1" step dual row connector and contain signals which could be used for connection to additional board. Vin is the entry point power supply and should be in range 6-12VDC.

MECHANICAL DIMENSIONS:

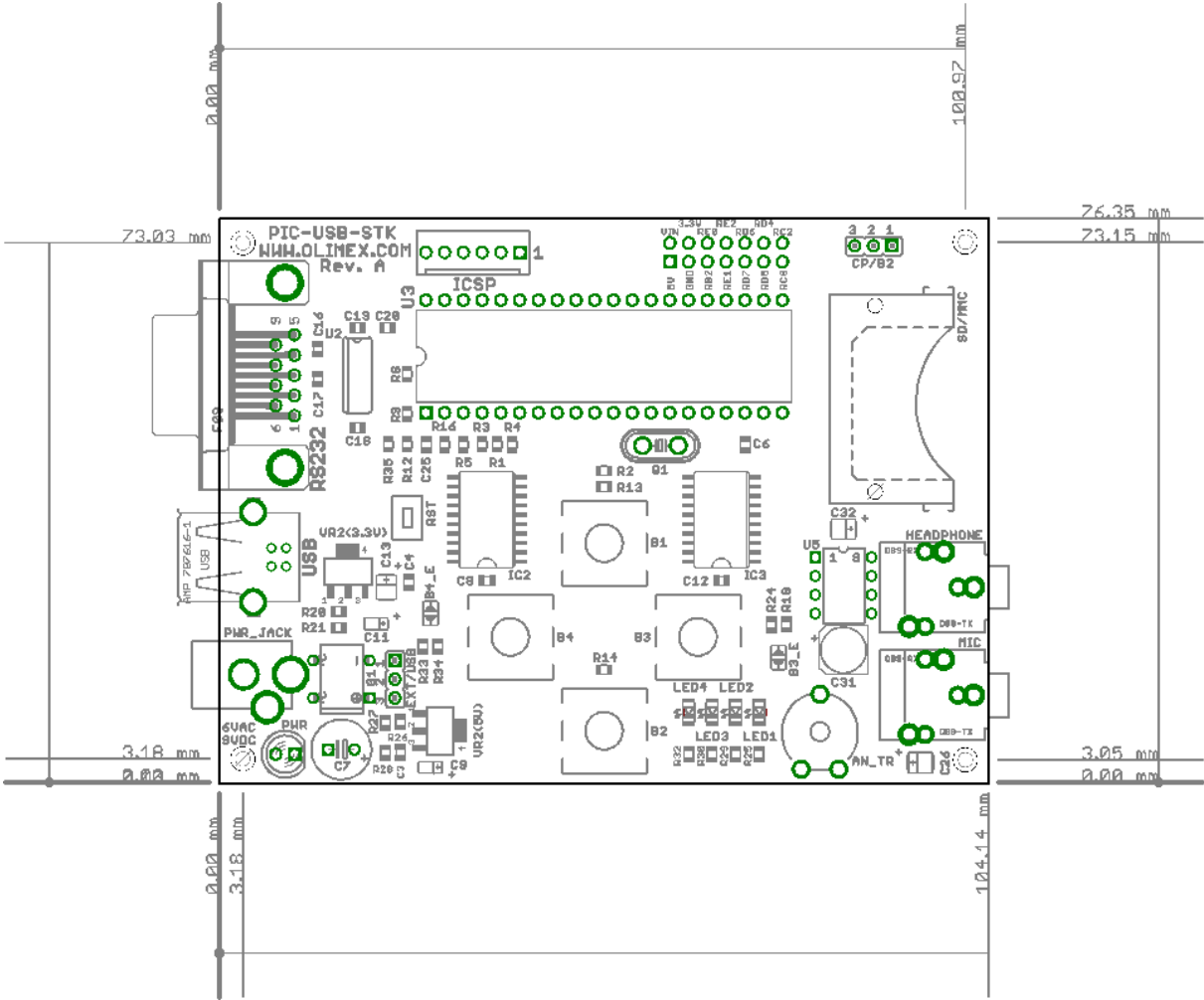

AVAILABLE DEMO SOFTWARE:

PIC-USB-STK is shipping with pre-programmed Microchip's USB bootloader and demo code. The Bootloader allow HEX files to be loaded in the PIC via USB interface using the free downloadable software from Microchip's web:

http://ww1.microchip.com/downloads/en/DeviceDoc/MCHPFSUSB_Setup_v1.3.exe

How to use the bootloader document is available at:

http://ww1.microchip.com/downloads/en/DeviceDoc/MCHPFSUSB_FW_UG_51679a.pdf

USB bootloader (C source and HEX)

The CP/B2 jumper should be in position B2, the EXT/USB should be in position USB. If you press and keep pressed the B2 button while apply power to the board or after Reset the bootloader is activated. If you have installed the PICDEM FS USB Demo Tool from the link above when you run it it will detect if the bootloader is activated and will allow you to load HEX files to the board without need for programmer. Of course if you erase the chip and the bootloader you will need programmer to load again bootloader HEX file inside the PIC.

HID Mouse demo (C source and HEX)

This is USB mouse demo, with the four buttons you can move your mouse cursor.

Mass Storage device (C source and HEX)

The CP/B2 jumper should be in CP position. Plug the USB cable before you insert MMC card in the SD/MMC connector. Then you have to plug the card in the connector. Windows will recognize and install the drivers for Mass Storage device and you will see your card as new drive.

If your card is inserted in the SD-MMC card connector when you plug USB the board will enter in bootloader mode.

USB RS232 converter (C source and HEX)

This demo code creates Virtual COM port. The drivers are in this folder:
C:\MCHPFSUSB\fw\Cdc\inf\win2k_winxp_winvista32

PIC-USB-STK demo code (C source and HEX)

This demo code is shipping with the board by default. You can read the trimpot value, control LED3, LED4 with the corresponding buttons. You should run PICDEM FS USB Demo Tool in demo mode to explore the capabilities.

Note: in all above examples the bootloader is included i.e. you can enter in bootloader mode by pressing B2 while in Reset. Be careful when you modify the codes as you may exclude the bootloader part when you compile the demo codes and in this case you will lose the bootloader code.

ORDER CODE:

How to order?

You can order to us directly or by any of our distributors.

Check our web www.olimex.com/dev for more info.



All boards produced by Olimex are ROHS compliant

Revision history:

REV.A - create March 2008

Disclaimer:

© 2008 Olimex Ltd. All rights reserved. Olimex®, logo and combinations thereof, are registered trademarks of Olimex Ltd. Other terms and product names may be trademarks of others.

The information in this document is provided in connection with Olimex products. No license, express or implied or otherwise, to any intellectual property right is granted by this document or in connection with the sale of Olimex products.

Neither the whole nor any part of the information contained in or the product described in this document may be adapted or reproduced in any material from except with the prior written permission of the copyright holder.

The product described in this document is subject to continuous development and improvements. All particulars of the product and its use contained in this document are given by OLIMEX in good faith. However all warranties implied or expressed including but not limited to implied warranties of merchantability or fitness for purpose are excluded.

This document is intended only to assist the reader in the use of the product. OLIMEX Ltd. shall not be liable for any loss or damage arising from the use of any information in this document or any error or omission in such information or any incorrect use of the product.