

# DIGITALVIEW®



Product Guide

LCD Controllers,  
Accessories &  
Engineering

May 2022

[www.digitalview.com](http://www.digitalview.com)

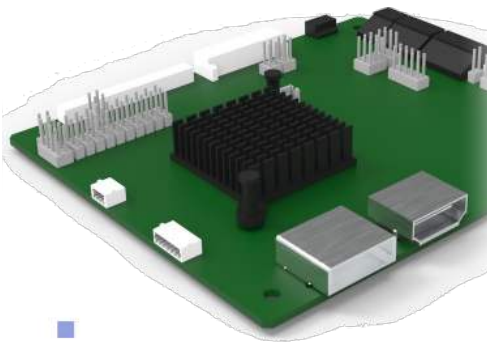

## Contents

|  |       |
|--|-------|
| Introduction                             | 3-6   |
| Capabilities                             | 7     |
| Selecting an LCD Panel Controller        | 8     |
| Customizing The Products                 | 9     |
| Product Comparison Table                 | 10-11 |
| <b>Multi-Purpose LCD Controllers</b>     |       |
| SVX-4096                                 | 12-13 |
| SVX-4096-120                             | 14-15 |
| DT-4096                                  | 16-17 |
| SVX-1920-PRO                             | 18-19 |
| SP-1920v2                                | 20-21 |
| ALT-1920                                 | 22-23 |
| DT-1920 Family                           | 24-25 |
| ALR-1400v2                               | 26-27 |
| <b>Multi-Purpose LCD Controllers</b>     |       |
| MIP-1000                                 | 28-29 |
| <b>Harsh Environment LCD Controllers</b> |       |
| HX-4096                                  | 30-31 |
| HDT-4096                                 | 32-33 |
| HX-2560-SDI                              | 34-35 |
| HX-1920-PRO                              | 36-37 |
| HLT-1920                                 | 38-39 |
| HE-1400v2                                | 40-41 |
| <b>Driver Boards For E Ink Panels</b>    |       |
| EPM-100v2                                | 42-43 |
| EPL-100                                  | 44-45 |
| EPM-050                                  | 46-47 |
| Accessories                              | 48-51 |

## Digital View

Since 1995 Digital View has been designing and producing LCD interface controller boards used by leading professional video display and monitor manufacturers around the globe. As 2022 progresses we will be adding more industry specific solutions to address the growing specialization of the display market.

Digital View controllers have been used in virtually every conceivable LCD display related application including...

- » Industrial Displays
- » Harsh Environment Displays
- » Defense and Security
- » Avionics, Marine and Rail
- » Healthcare Imaging Systems
- » Video Broadcast & Studios
- » Digital Signage for Retail, Advertising & Information
- » Corporate Audio Visual display systems for collaboration
- » Interactive displays and kiosks, way-finding
- » Architectural display systems



## Why Digital View...

Now in our 28th year of consistent performance as the leading specialist LCD controller board developer, manufacturer and solution provider for application specific monitors and display systems. Having pioneered the development of specialty LCD interface controllers and many value added functions, Digital View provides a highly skilled, passionate engineering team with custom engineering and support services, including a wide range of accessories to complement core products.

Digital View:

- » Supports product concept, design, prototypes and mass production.
- » Supports the LCD panel suppliers that customers select.
- » Provides the engineering services & expertise to meet the needs of the display industry.
- » Supports legacy applications and long life-cycle production.
- » Supplies a cost effective sub-assembly solution so companies can focus on their goals.
- » Reduces time to market and increases ROI.
- » QC - 100% production testing with QA verification.
- » Meets application specific standards and compliance criteria.

## Commercial Off-The-Shelf



Video



Industrial

Medical



## Harsh Environments

Aviation



Digital Signage



Marine



## Display Acronyms

### Monitors

|       |             |
|-------|-------------|
| WQXGA | 2560 x 1600 |
| WUXGA | 1920 x 1200 |
| UXGA  | 1600 x 1200 |
| WXGA  | 1366 x 768  |
| SXGA  | 1280 x 1024 |
| XGA   | 1024 x 768  |
| SVGA  | 800 x 600   |
| VGA   | 640 x 480   |

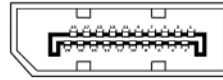
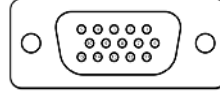

### HD

|           |             |
|-----------|-------------|
| 8K UHD    | 7680 x 4320 |
| 5K / UHD+ | 5120 x 2880 |
| True 4K   | 4096 x 2160 |
| UHD / 4K  | 3840 x 2160 |
| FHD       | 1920 x 1080 |
| HD        | 1280 x 720  |

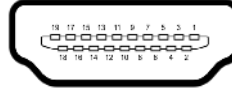

### TV

|               |                             |
|---------------|-----------------------------|
| 1080p / 1080i | 1920 x 1080                 |
| 720p / 720i   | 1280 x 720                  |
| 480p / 480i   | 640 x 480                   |
| PAL           | 625 scan lines, 576 visible |
| NTSC          | 525 scan lines, 480 visible |



## LCD Panels Supported...



...and more

## Capabilities

Digital View is known throughout the display industry for high-end reliability and an expanded features set of advanced functionality. We have a proven track record for display system related innovation and on-time and on-budget project delivery.

## Engineering Services

Digital View provides display solution related engineering to customers:

- » Input signal support
- » LCD panel resolution & timing support
- » Feature enhancements
- » OSD modifications
- » System monitoring with remote access
- » Splash screen branding
- » Add-on board designs
- » Custom controller layouts
- » Complete turnkey controller development

## Scalable Manufacturing

Digital View supports display projects of all sizes and phases of development, from prototype to volume production.

## Quality Control & Reliability

Digital View recognizes the demanding requirements of customer's display applications and takes a holistic approach to quality from specification, design, qualified partners, parts sourcing, production, quality control and support.

## Environmental Standards Compliance & Disclosures

Digital View seeks to meet the ever developing standards for environmental protection as well as supporting customers with their disclosure requirements.

## Selecting an LCD Controller Board

Digital View LCD controllers are suitable for large, medium and small non-consumer display systems.

### Panel Resolution

Digital View LCD controllers support from 640x480 through to 1920x1200, 2560x1600, 3840x2160 and 4096x2160 to meet the panels available on the market and the requirements of the ultimate display application. In addition to the standard display resolutions, cut or banner panel and custom resolutions are also supported. If you are looking for a controller to match a panel, a good place to start is the Controller Solution Generator at [www.digitalview.com/csg](http://www.digitalview.com/csg)

### Signal Inputs

Support for signal formats, resolutions and connectors such as HDMI, DVI, Displayport, 3G-SDI & HD-SDI, Fiber, Component, VGA - ARGB, Composite, together with legacy system support such as Sync-On-Green.

### Features & Functions RS-232 & Ethernet

After many years of providing LCD controllers, there is an extensive list of solutions for nearly every type of display application. Some of the functions are listed in the controller summary pages that follow, otherwise please contact your nearest Digital View office or authorized reseller as listed on [www.digitalview.com/partners/resellers.html](http://www.digitalview.com/partners/resellers.html) for assistance.

### User Interface

Buttons, hot-buttons, mobile device apps (IOS and Android), auto-switching and remote control are just some of the display control options available. Typically, these are enabled by Digital View Accessories or via the extensive serial commands through RS-232 or LAN interface built into Digital View LCD controllers.

### Harsh Environments

Heat, vibration, humidity, dust and other airborne contaminants are catered for with the Harsh Environment models. If this is not required then the General Purpose models should be suitable.

## Custom Engineering

Digital View provides extensive custom engineering services  
Contact us for details

## Controller Solution Generator

For downloads of connection diagrams with details of cables  
and settings to match a LCD panel with a controller

[www.digitalview.com/csg](http://www.digitalview.com/csg)



## Customization

All standard Digital View LCD controller products can be customized either at the production stage or by Digital View engineering to suit a particular display application. Digital View also undertakes custom layout development for matching controller design to a specific customer enclosure. The following are some examples; for particular controller models there may be some technical limitations.

### Splash Screen

Brand owners can have their logo shown when the display initiates

### Menus & Functions

On-screen menu design and modification as well as addition or removal of functions

### Menu Buttons

Standard or custom menu buttons either direct or via RS-232 or Ethernet

### Menu Languages

Lock the on-screen menu to your language or have a new language added

### Function Presets

Assign fixed functions to OSD and menu buttons

### Panel Timing & Resolution

Set up timings and support for non-standard panel resolutions

### Input Signals

Customization includes support for non-standard input signals as well as port & signal locking

### Testing & Calibration

Testing, certification and calibration services are available to meet industry standards

### Cables

Although standard cables meet most applications, custom cables are available

### Custom layouts

Custom board layout to match the mechanical requirements of a display enclosure

### Port Naming

Custom port name display

### Windows, Android & IOS Apps

Extending control and functionality of the LCD controller board with software

## LCD Controller Boards

| Model                                     | Photo | Panel Resolutions                          | Color (up to) | Panel Voltage                   | Input Signals   | Commands & Control   | Other   |
|---|-------|--|---------------|---------------------------------|---|--|---|
| SVX-4096<br>203mm x 154mm                 |       | 4096 x 2160<br>V-by-One<br>eDP<br>LVDS     | 10 Bit        | 3.3v<br>5v<br>10v<br>12v<br>18v | HDMI x3<br>DVI-I Dual<br>Link x1<br>Displayport x1<br>VGA x1 on DVI-I               | OSD Buttons<br>IR Remote<br>Ethernet<br>RS-232                       | DICOM<br>Quad PiP<br>Sensors<br>12/24V DC in<br>PWM, DPMS   |
| SVX-4096-120<br>203mm x 194mm             |       | 4096 x 2160<br>60Hz,<br>120Hz<br>V-by-One  | 10 Bit        | 3.3v<br>5v<br>10v<br>12v<br>18v | HDMI x3<br>DVI-I Dual<br>Link x1<br>Displayport x1<br>VGA x1 (on DVI-I)             | OSD Buttons<br>IR Remote<br>Ethernet<br>RS-232                       | Quad PiP<br>Sensors<br>12/24V DC in<br>PWM, DPMS            |
| DT-4096<br>107mm x 92mm                   |       | 4096 x 2160<br>V-by-One<br>eDP             | 10 Bit        | 3.3v<br>5v<br>10v<br>12v<br>18v | HDMI x1<br>Displayport x1   | OSD Buttons<br>IR Remote<br>RS-232                                   | 12/24V DC in<br>PWM, DPMS                                   |
| SVX-1920-PRO<br>179mm x 120mm             |       | up to<br>1920 x 1200<br>LVDS               | 10 Bit        | 3.3v<br>5v<br>10v<br>12v<br>18v | HDMI x1<br>Displayport x1<br>DVI-D x1<br>VGA x 1<br>3G-SDI option                   | OSD Buttons<br>IR Remote<br>Ethernet option<br>RS-232                | PIP, PbP<br>Image rotate<br>12/24V DC In<br>PWM, Analog     |
| SP-1920v2<br>179mm x 120mm<br>Due Q3 2022 |       | up to<br>1920 x 1200<br>LVDS               | 10 Bit        | 3.3v<br>5v<br>10V<br>12v<br>18v | HDMI x2<br>DVI-D x1 /<br>VGA x1<br>Component x1<br>Composite x1<br>USB for failover | OSD Buttons<br>IR Remote<br>RS-232                                   | Input failover<br>Image rotate<br>12/24V DC In<br>PWM, DPMS |
| ALT-1920<br>108mm x 92mm                  |       | up to<br>1920 x 1200<br>LVDS               | 8 Bit         | 3.3v<br>5v<br>12v<br>18v        | HDMI x1<br>Displayport x1<br>VGA x1   | OSD Buttons<br>IR Remote<br>RS-232                                   | 12/24V DC In<br>PWM, DPMS                                   |
| DT-1920<br>Family                         |       | up to<br>1920 x 1200<br>LVDS               | 8 Bit         | 3.3v<br>5v<br>12v               | HDMI<br>Displayport<br>VGA  | OSD Buttons<br>IR Remote<br>RS-232                                   | 12V DC Input<br>PWM, DPMS                                   |
| ALR-1400v2<br>108mm x 92mm                |       | up to<br>1440 x 900<br>LVDS,<br>TTL option | 8 Bit         | 3.3v<br>5v<br>12v<br>18v        | DVI-D x1<br>VGA x1  | OSD Buttons<br>IR Remote<br>RS-232                                   | 12/24V DC In<br>PWM, DPMS                                   |
| Model                                     | Photo | Panel Resolutions                          | Color (up to) | Panel Voltage                   | Input Signals   | Commands & Control   | Other   |
| MIP-1000<br>65mm x 64mm                   |       | Up to<br>2160x3840<br>MIPI DSI             | 8 Bit         | 1.8v<br>3.3v<br>5.8v            | HDMI  | OSD Buttons<br>IR Remote<br>Mini PCIe slot<br>RS-232 (serial)<br>USB | 5V DC Input<br>PWM backlight                                |

## Accessories are on pages 48 to 51

Accessories include panel cables, OSD buttons, add-on boards and more

## Harsh Environment LCD Controller Boards

| Model                               | Photo  | Panel Resolutions                            | Color (up to) | Panel Voltage                   | Input Signals  | Command & Control                                      | Other   |
|-------------------------------------|--|--|---------------|---------------------------------|--|--|---|
| <b>HX-4096</b><br>203mm x 154mm     |   | up to 4096 x 2160<br>V-by-One<br>eDP<br>LVDS | 10 Bit        | 3.3V<br>5V<br>10V<br>12V<br>18V | HDMI x3<br>DVI-Dual Link x1<br>Displayport x1<br>VGA x1 (on DVI-I) | OSD Buttons<br>IR Remote<br>Ethernet<br>RS-232         | DICOM<br>Quad input<br>Sensors<br>12/24V DC in<br>PWM, DPMS |
| <b>HDT-4096</b><br>107mm x 92mm     |   | 4096 x 2160<br>V-by-One<br>eDP               | 10 Bit        | 3.3V<br>5V<br>10V<br>12V<br>18V | HDMI x1<br>Displayport x1  | OSD Buttons<br>IR Remote<br>RS-232                     | 12/24V DC in<br>PWM, DPMS                                   |
| <b>HX-2560-SDI</b><br>127mm x 102mm |   | up to 2560 x 1600<br>LVDS                    | 10 Bit        | 3.3V<br>5V<br>10V<br>12V<br>18V | HDMI x 2<br>Displayport x 1<br>VGA x 1<br>3G/HD-SDI x 1            | OSD Buttons<br>IR Remote<br>RS-232                     | PIP, PbP<br>Image rotate<br>12/24V DC In<br>PWM, Analog     |
| <b>HX-1920-PRO</b><br>179mm x 120mm |   | up to 1920 x 1200<br>LVDS                    | 10 Bit        | 3.3V<br>5V<br>10V<br>12V<br>18V | HDMI x1<br>Displayport x1<br>DVI-D x1<br>VGA x1<br>3G-SDI option   | OSD Buttons<br>IR Remote<br>Ethernet, option<br>RS-232 | PIP, PbP<br>Image rotate<br>12/24V DC In<br>PWM, DPMS       |
| <b>HLT-1920</b><br>108mm x 92mm     |   | up to 1920 x 1200<br>LVDS                    | 8 Bit         | 3.3V<br>5V<br>12V<br>18V        | HDMI x1<br>Displayport x1<br>VGA x1                                | OSD Buttons<br>IR Remote<br>RS-232                     | 12/24V DC In<br>PWM, DPMS                                   |
| <b>HE-1400v2</b><br>108mm x 92mm    |  | up to 1440 x 900<br>LVDS,<br>TTL option      | 8 Bit         | 3.3V<br>5V<br>12V<br>18V        | DVI-D x1<br>VGA x1   | OSD Buttons<br>IR Remote<br>RS-232                     | 12/24V DC In<br>PWM, DPMS                                   |

## Driver Boards For E Ink Panels

| Model            | Photo   | Panel Size | Color          |  | Input Signals | Command + Control | Other        |
|------------------|---|------------|----------------|--|---------------|-------------------|--------------|
| <b>EPM-100v2</b> |   | 32", 42"   | Mono           |  | USB           | RS-232            | 12V DC Input |
| <b>EPL-100</b>   |   | 25.3", 28" | Mono,<br>Color |  | USB           | RS-232            | 12V DC Input |
| <b>EPM-050</b>   |  | 13.3"      | Mono           |  | USB           | RS-232            | 12V DC Input |

Accessories : Pg 56-59

## SVX-4096

Part No : 4175500xx-3

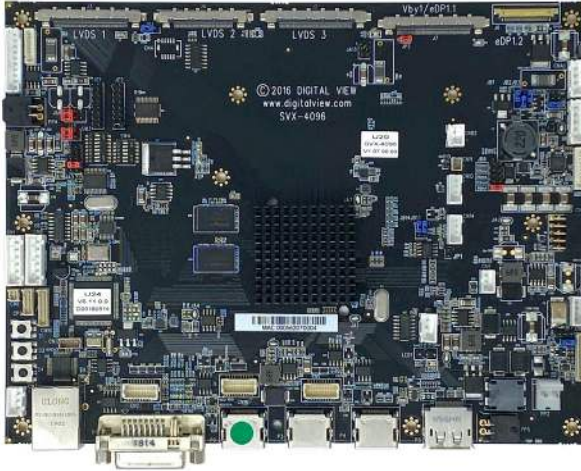

The SVX-4096 is an advanced controller supporting LCD & OLED panels up to 4096 x 2160 resolution

### Features:

- » Up to 4096 x 2160 input, 10 bit / Up to 4096 x 2160 LCD panels, 10 bit
- » HDMI 2.0, HDMI 1.4, DisplayPort 1.2, DVI-I Dual Link
- » V-by-One, eDP, LVDS panel connection @60Hz (& 120Hz with IE-2000)
- » Full frame memory buffer for enhanced image control
- » Ethernet, RS-232, Infra-red remote control, External buttons

### Panel Connection

**V-by-One:** up to 4096 x 2160 @60Hz  
(8 channel)

add IE-2000 for 120Hz

**eDP (HBR/HBR2)** up to 4096 x 2160 @60Hz  
**LVDS (8 channel)** up to 4096 x 2160 @60Hz

**Panel resolutions** 4096 x 2160, 3840 x 2160,  
2560 x 1440/1600  
1920 x 1200, 1920 x 1080

### Input Signal

**HDMI 2.0** 60Hz up to 4096 x 2160  
75Hz up to 1600 x 1200

**HDMI 1.4** 30Hz up to 4096 x 2160  
60Hz up to 2560 x 1600  
75Hz up to 1600 x 1200

**Displayport 1.2** 60Hz up to 4096 x 2160  
75Hz up to 1600 x 1200

**DVI-I Dual Link (includes VGA)** 30Hz up to 4096 x 2160  
60Hz up to 2560 x 1600  
75Hz up to 1600 x 1200

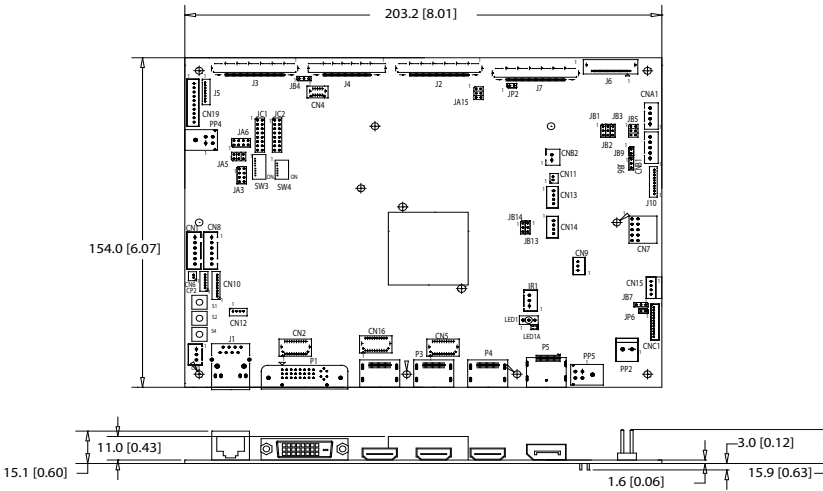

## Functions:

**Display:** On Screen Display (OSD)

**Controls:** External buttons, Infra-Red, Serial RS-232, Ethernet

**Image Control:** Brightness, Contrast, Color Temperature, Image position, Saturation, Hue, Sharpness, Up/Down scaling to fit input to panel resolution

**Other:** System information, Scaling to fill screen and fill to aspect ratio, Programmable hot-keys, Factory reset, Quad input support, Picture-in-Picture (PiP), Picture by Picture (PbP), Ambient light sensor support\*, Enable frame buffer for FRC image enhancement, OSD menu transparency, DDC-CI support\*

## Specifications - other:

**Colors:** 10 bit input / 10 bit panel support

**Panel Power:** 3.3V, 5V, 10V, 12V, 18V

**Input Power:** 12/24V DC +/- 5%, 10W

**Inverter Support:** DPMS enable (3.3V or 5V), PWM

**Plug & Play:** DDC 1, 2/b compatible

**Status indicator:** Dual color LED support

**MTBF:** 100,000 hours

**RoHS compliant:** Yes

**Warranty:** 3 Years

## Accessories:

|                           |                    |
|---------------------------|--------------------|
| IE-2000, for 120Hz panels | P/N 4175600XX-3    |
| Inverter interface board  | [subject to panel] |
| IR remote control         | P/N 5590001XX-3    |
| OSD digital button board  | Kit 67110-3        |
| OSD membrane kit - Ver    | Kit 67134-3        |
| OSD membrane kit - Hor    | Kit 67135-3        |
| Audio Add-on board        | P/N 416940020-3    |

## On the Website

[www.digitalview.com/controllers/svx-4096-lcd-controller.html](http://www.digitalview.com/controllers/svx-4096-lcd-controller.html)

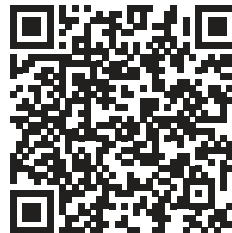

## SVX-4096-120

Part No : 4175900xx-3



The SVX-4096-120 is a full function controller supporting 60Hz and 120Hz LCD panels up to 4096 x 2160 resolution

### Features:

- » Up to 4096 x 2160 input, 10 bit / Up to 4096 x 2160 120Hz LCD panels, 10 bit
- » HDMI 2.0, HDMI 1.4, DisplayPort 1.2 (& pass-through output), DVI-I Dual Link
- » V-by-One panel connection @60Hz/120Hz
- » Full frame memory buffer for enhanced image control
- » Ethernet, RS-232, Infra-red remote control, External buttons

### Panel Connection

**V-by-One:** up to 4096 x 2160  
**(8 & 16 channel)** @60Hz & 120Hz

**Panel resolutions** 4096 x 2160, 3840 x 2160  
 1920 x 1200, 1920 x 1080

### Input Signal

**HDMI 2.0** 60Hz up to 4096 x 2160  
 75Hz up to 1600 x 1200

**HDMI 1.4** 30Hz up to 4096 x 2160  
 60Hz up to 2560 x 1600  
 75Hz up to 1600 x 1200

**Displayport 1.2** 60Hz up to 4096 x 2160  
 75Hz up to 1600 x 1200

**DVI-I Dual Link (includes VGA)** 30Hz up to 4096 x 2160  
 60Hz up to 2560 x 1600  
 75Hz up to 1600 x 1200

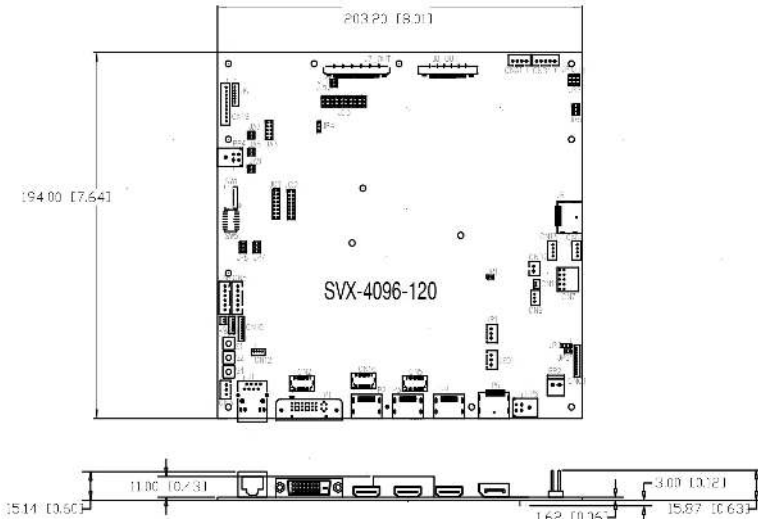

## Functions:

**Display:** On Screen Display (OSD)

**Controls:** External buttons, Infra-Red, Serial RS-232, Ethernet

**Image Control:** Brightness, Contrast, Color Temperature, Image position, Saturation, Hue, Sharpness, Up/Down scaling to fit input to panel resolution, Image flip.

**Other:** System information, Scaling to fill screen and fill to aspect ratio, Programmable hot-keys, Factory reset, Quad input support, Picture-in-Picture (PiP), Picture by Picture (PbP), Ambient light sensor support\*, Enable frame buffer for FRC image enhancement, OSD menu transparency, DDC-CI support\*

## Accessories:

|                          |                    |
|--------------------------|--------------------|
| Inverter interface board | [subject to panel] |
| IR remote control        | P/N 5590001XX-3    |
| OSD digital button board | Kit 67110-3        |
| OSD membrane kit - Ver   | Kit 67134-3        |
| OSD membrane kit - Hor   | Kit 67135-3        |
| Audio Add-on board       | P/N 416940020-3    |

## Specifications - other:

**Colors:** 10 bit input / 10 bit panel support

**Panel Power:** 3.3V, 5V, 10V, 12V, 18V

**Input Power:** 12/24V DC +/- 5%, 10W

**Inverter Support:** DPMS enable (3.3V or 5V), PWM

**Plug & Play:** DDC 1, 2/b compatible

**Status indicator:** Dual color LED support

**MTBF:** 100,000 hours

**RoHS compliant:** Yes

**Warranty:** 3 Years

## On the Website

[digitalview.com/controllers/svx-4096-120-lcd-controller.html](http://digitalview.com/controllers/svx-4096-120-lcd-controller.html)



## DT-4096

Part No : 4178200xx-3



## The DT-4096 controller for LCD panels up to 4096 x 2160 with HDMI & Displayport inputs, and V-by-One, eDP panels

### Features:

- » Up to 4096 x 2160 input, 10 bit / Up to 4096 x 2160 LCD panels, 10 bit
- » HDMI ( x1), Displayport (x1)
- » V-by-One, eDP panel connection @60Hz refresh rate
- » RS-232 (Serial), Infra-red remote control, External buttons

### Panel Connection

V-by-One, eDP up to 4096 x 2160 @60Hz

Panel resolutions Most standard & custom resolutions up to 4096 x 2160

### Input Signal

HDMI 2.0 60Hz up to 4096 x 2160

Displayport 1.2 60Hz up to 4096 x 2160



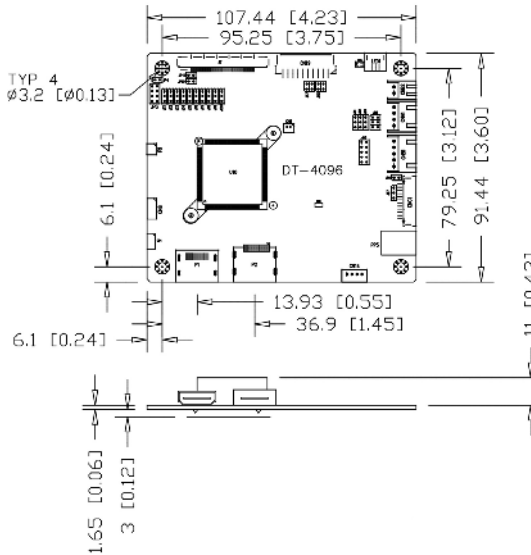

## Functions:

**Display:** On Screen Display (OSD)

**Controls:** External buttons, Infra-Red, Serial RS-232

**Main:** Backlight brightness, Contrast, Color Temperature, Saturation, Hue, Sharpness, Black level

**Other:** Input source select, Auto source seek, Display rotate, OSD position, OSD timeout, OSD menu transparency, Volume control, Programmable hotkeys, System Information, Image scaling - Up/Down scaling to fit input to panel resolution & aspect ratio. Load factory defaults.

## Specifications - other:

**Colors:** 10 bit input / 10 bit panel support

**Panel Power:** 3.3V, 5V, 10V, 12V, 18V

**Input Power:** 12/24V DC +/- 5%, 4W

**Inverter Support:** DPMS enable (3.3V or 5V), PWM

**Plug & Play:** DDC 1, 2/b compatible

**Status indicator:** Dual color LED support

**MTBF:** over 100,000 hours

**RoHS compliant:** Yes

**Warranty:** 3 Years

## On the Website

[digitalview.com/controllers/dt-4096-lcd-controller.html](http://digitalview.com/controllers/dt-4096-lcd-controller.html)

## Accessories

|                          |                 |
|--------------------------|-----------------|
| OSD Digital Button Board | Kit 67110-3     |
| OSD Vertical Membrane    | Kit 67135-3     |
| OSD Horizontal Membrane  | Kit 67134-3     |
| Inverter Interface board | P/N 416040010-3 |
| IR Remote Control        | P/N 5590001XX-3 |



## SVX-1920-PRO

Part No : 4177300xx-3



### The SVX-1920-PRO replaces the SVX-1920v3 & SVH-1920v2

**Features:**

- » Up to 1920 x 1200 input, 10 bit / Up to 1920 x 1200 LCD panels, 10 bit
- » HDMI, Displayport, DVI-I (DVI-D & VGA)
- » LVDS panel connection @60Hz refresh rate
- » Full frame memory buffer for enhanced image control
- » RS-232 (Serial), Infra-red remote control, External buttons

### Panel Connection

**LVDS (2 channel)** up to 1920 x 1200 @60Hz

**Panel resolutions** Most standard & custom resolutions up to 1920 x 1200

### Input Signal

**HDMI 1.4** 60Hz up to 1920 x 1200 1080p, 1080i, 720p, 576p, 480p

**Displayport** 60Hz up to 1920 x 1200 1080p, 1080i, 720p, 576p, 480p

**DVI-I (ARGB)** 60Hz up to 1920 x 1200 75Hz up to 1280 x 1024

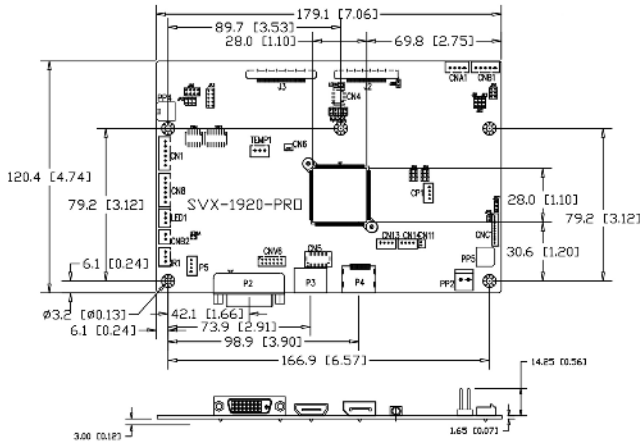

## Functions:

**Display:** On Screen Display (OSD)

**Controls:** External buttons, Infra-Red, Serial RS-232

**Image Control:** Brightness, Contrast, Color Temperature, Image position, Saturation, Hue, Black level, Gamma, Sharpness, Up/Down scaling to fit input to panel resolution

**Other:** System Information, OSD position, Scaling to fill screen and fill to aspect ratio, OSD timeout, Factory reset, OSD menu transparency, Horizontal & Vertical image inversion, Picture in Picture (PiP) variable position & any input combination (5 sizes), Picture by Picture, Programmable hot-keys, Serial port protocol, Ambient light sensor support, Fast input switching, Ambient temperature sensor.

## Accessories

|                          |                 |
|--------------------------|-----------------|
| OSD Digital Button Board | Kit 67110-3     |
| OSD Vertical Membrane    | Kit 67135-3     |
| OSD Horizontal Membrane  | Kit 67134-3     |
| Inverter Interface Board | P/N 416040010-3 |
| IR Remote Control        | P/N 5590001XX-3 |

## Specifications - other:

**Colors:** 10 bit input / 10 bit panel support

**Panel Power:** 3.3V, 5V, 10V, 12V, 18V

**Input Power:** 12/24V DC +/- 5%, 4W

**Inverter Support:** DPMS enable (3.3V or 5V), PWM

**Plug & Play:** DDC 1, 2/b compatible

**Status indicator:** Dual color LED support

**MTBF:** 100,000 hours

**RoHS compliant:** Yes

**Warranty:** 3 Years

## On the Website

[digitalview.com/controllers/svx-1920-pro-lcd-controller.html](http://digitalview.com/controllers/svx-1920-pro-lcd-controller.html)



## SP-1920v2

Part No : 4178100xx-3

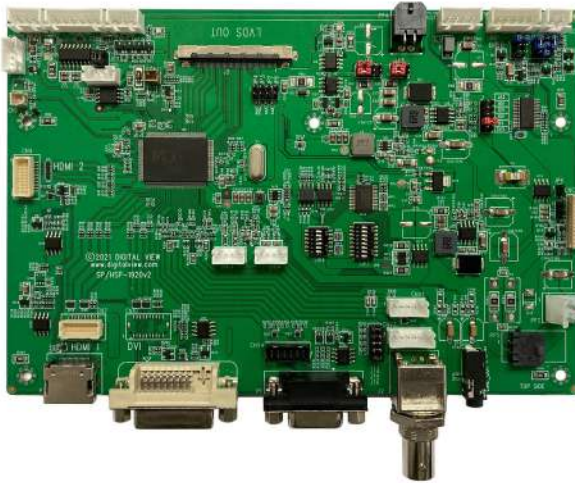

### The SP-1920v2 controller for LCD panels up to 1920 x 1200 with HDMI, DVI, ARGB, Component & Composite inputs

#### Features:

- » Up to 1920 x 1200 input, 8 bit / Up to 1920 x 1200 LCD panels, 10 bit
- » HDMI (x1+1), DVI-D, VGA, Composite, Component
- » LVDS panel connection @60Hz refresh rate
- » MP4 built-in media player for input source failover
- » RS-232 (Serial), Infra-red remote control, External buttons

#### Panel Connection

**LVDS (2 channel)** up to 1920 x 1200 @60Hz

**Panel resolutions** Most standard & custom resolutions up to 1920 x 1200

#### Input Signal

**HDMI** 60Hz up to 1920 x 1200

**DVI** 60Hz up to 1920 x 1200

**ARGB (VGA)** 60Hz up to 1920 x 1200

**Composite** PAL, NTSC

**Component** PAL, NTSC  
480p, 576p, 720p, 1080i, 1080p

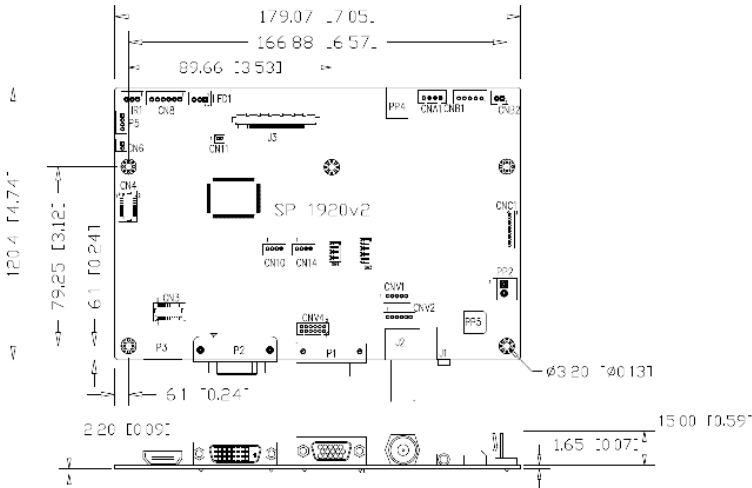

## Functions:

**Display:** On Screen Display (OSD)

**Controls:** External buttons, Infra-Red, Serial RS-232

**Main:** Backlight brightness, Contrast, Color Temperature, Image positioning, Saturation, Hue, Sharpness, Black level

**Other:** Input source select, Auto source seek, Auto picture setup, Auto color gain, Manual clock & phase, OSD timeout, OSD menu transparency, Image orientation, System Information, Image scaling - Up/Down scaling to fit input to panel resolution & aspect ratio. Load factory defaults.

**Media failover:** MP4 from USB

## Accessories

|                          |                 |
|--------------------------|-----------------|
| 3G HD-SDI support        | Kit 70700-3     |
| OSD Digital Button Board | Kit 67110-3     |
| OSD Vertical Membrane    | Kit 67135-3     |
| OSD Horizontal Membrane  | Kit 67134-3     |
| Inverter Interface board | P/N 416040010-3 |
| IR Remote Control        | P/N 5590001XX-3 |

## Specifications - other:

**Colors:** 10 bit input / 10 bit panel support

**Panel Power:** 3.3V, 5V, 10V, 12V, 18V

**Input Power:** 12/24V DC +/- 5%, 2.5W (controller only)

**Inverter Support:** DPMS enable (3.3V or 5V), PWM

**Plug & Play:** DDC 1, 2/b compatible

**Status indicator:** Dual color LED support

**MTBF:** over 100,000 hours

**RoHS compliant:** Yes

**Warranty:** 3 Years

## On the Website

[digitalview.com/controllers/sp-1920v2-lcd-controller.html](http://digitalview.com/controllers/sp-1920v2-lcd-controller.html)

## ALT-1920

Part No : 41764001x-3



The ALT-1920 is a compact controller for LCD panels up to 1920 x 1200 with HDMI, Displayport & ARGB inputs

**Features:**

- » Up to 1920 x 1200 input, 8 bit / Up to 1920 x 1200 LCD panels, 8 bit
- » HDMI, Displayport, Analog RGB (VGA)
- » LVDS panel connection @60Hz refresh rate
- » RS-232 (Serial), Infra-red remote control, External buttons

### Panel Connection

**LVDS (2 channel)** up to 1920 x 1200 @60Hz

**Panel resolutions** Most standard & custom resolutions up to 1920 x 1200

### Input Signal

**HDMI** 60Hz up to 1920 x 1200

**Displayport** 60Hz up to 1920 x 1200

**ARGB (VGA)** 60Hz up to 1920 x 1200

### Customization

Customization options: Panel timing; Custom input timing; Splash screen logo, ie during start-up; Custom hotkeys , menus, commands; Custom EDID; Build options to omit connectors; Full PCBA layout, conformal coatings & other hardware changes; Software utilities or Apps (IOS or Android) for RS-232 control

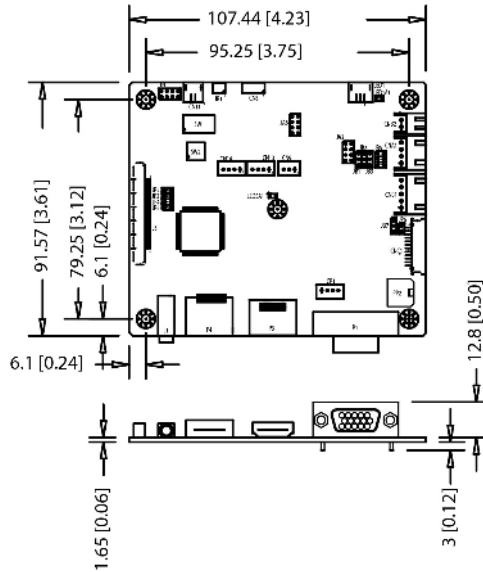

## Functions:

**Display:** On Screen Display (OSD)

**Controls:** External buttons, Infra-Red, Serial RS-232

**Image Control:** Black level, Contrast, Sharpness, Clock, Phase, Color temperature, Image position, Gamma, Auto picture setup, Auto RGB calibration

**Other:** Backlight brightness, Auto source seek, OSD timeout, OSD position, OSD menu rotation, OSD transparency, Select input source, Volume control, Load factory defaults

## Accessories

|                          |                 |
|--------------------------|-----------------|
| OSD Digital Button Board | Kit 67110-3     |
| OSD Vertical Membrane    | Kit 67135-3     |
| OSD Horizontal Membrane  | Kit 67134-3     |
| Inverter Interface board | P/N 416040010-3 |
| IR Remote Control        | P/N 5590001XX-3 |

## Specifications - other:

**Colors:** 8 bit input / 8 bit panel support

**Panel Power:** 3.3V, 5V, 12V, 18V

**Input Power:** 12/24V DC +/- 5%, 2.5W controller only

**Inverter Support:** DPMS enable (3.3V or 5V), PWM

**Plug & Play:** DDC 1, 2/b compatible

**Status indicator:** Dual color LED support

**MTBF:** over 200,000 hours

**RoHS compliant:** Yes

**Warranty:** 3 Years

## On the Website

[digitalview.com/controllers/alt-1920-lcd-controller.html](http://digitalview.com/controllers/alt-1920-lcd-controller.html)



## DT-1920 Family



The DT-1920 family includes single input format controllers for LCD panels up to 1920 x 1200 resolution

**Features:**

- » Models supporting inputs: HDMI, Displayport, VGA
- » Up to 1920 x 1200 input, 8 bit / Up to 1920 x 1200 LCD panels, 8 bit
- » LVDS panel connection @60Hz refresh rate
- » eDP panel connection @60Hz refresh rate
- » RS-232 (Serial), Infra-red remote control, External buttons

### Panel Connection

**LVDS (2 channel)** up to 1920 x 1200 @60Hz  
**eDP** up to 1920 x 1200 @60Hz

**Panel resolutions** Most standard & custom resolutions up to 1920 x 1200

### Input Signal

60Hz to 1920x1200

|                         |                   |
|-------------------------|-------------------|
| <b>DT-1920-HDMI</b>     | HDMI              |
| <b>DT-1920-DP</b>       | Displayport       |
| <b>DT-1920-VGA</b>      | VGA               |
| <b>DT-1920-HDMI-EDP</b> | HDMI / Micro HDMI |



| Model            | Part No.  | Size (L x W x H) mm                       |
|------------------|---|---|
| DT-1920-HDMI     | 4177000xx-3   | 91.4 x 62.7 x 11mm                        |
| DT-1920-DP       | 4177400xx-3   | 91.4 x 62.7 x 11mm                        |
| DT-1920-VGA      | 4177500xx-3   | 91.4 x 62.7 x 16.5mm                      |
| DT-1920-HDMI-EDP | 4176600xx-3 micro-HDMI<br>4176602xx-3 standard HDMI | 91.4 x 91.4 x 4.0mm<br>91.4 x 91.4 x 11mm |

## Functions:

**Display:** On Screen Display (OSD)  
**Controls:** External buttons, Infra-Red, Serial RS-232  
**Image Control:** Brightness, Contrast, Color temperature, Gamma, Sharpness  
**Other:** Auto source seek, OSD timeout, OSD position, OSD menu rotation, OSD transparency

## Accessories

OSD Digital Button Board Kit 67110-3  
 OSD Vertical Membrane Kit 67135-3  
 OSD Horizontal Membrane Kit 67134-3  
 Inverter Interface board P/N 416040010-3  
 IR Remote Control P/N 5590001XX-3

## Specifications - other:

**Colors:** 8 bit input / 8 bit panel support  
**Panel Power:** 3.3V, 5V, 12V  
**Input Power:** 12V DC +/- 5%, 10W  
**Inverter Support:** DPMS enable (3.3V or 5V), PWM  
**Plug & Play:** DDC 1, 2/b compatible  
**Status indicator:** Dual color LED support  
**MTBF:** over 100,000 hours  
**RoHS compliant:** Yes  
**Warranty:** 3 Years

## On the Website

[digitalview.com/controllers/dt-1920-hdmi-lcd-controller.html](http://digitalview.com/controllers/dt-1920-hdmi-lcd-controller.html)

[digitalview.com/controllers/dt-1920-dp-lcd-controller.html](http://digitalview.com/controllers/dt-1920-dp-lcd-controller.html)

[digitalview.com/controllers/dt-1920-vga-lcd-controller.html](http://digitalview.com/controllers/dt-1920-vga-lcd-controller.html)

[digitalview.com/controllers/dt-1920-hdmi-edpt-lcd-controller.html](http://digitalview.com/controllers/dt-1920-hdmi-edpt-lcd-controller.html)

## ALR-1400v2

Part No : 4175800xx-3



The ALR-1400v2 is a compact LCD controller supporting LCD panels up to 1440 x 900 resolution with TTL and LVDS connection

**Features:**

- » Up to 1366 x 768 input, 8 bit / Up to 1440 x 900 LCD panels, 8 bit
- » DVI-D, Analog RGB (VGA)
- » LVDS & TTL panel connection @60Hz refresh rate
- » RS-232 (Serial), External buttons

### Panel Connection

**LVDS (2 channel)** up to 1440 x 900 @60Hz  
**TTL** up to 1440 x 900 @60Hz

**Panel resolutions** Most standard & custom resolutions up to 1440 x 900

### Input Signal

**DVI-D** 60Hz up to 1366 x 768

**ARGB (VGA)** 60Hz up to 1366 x 768

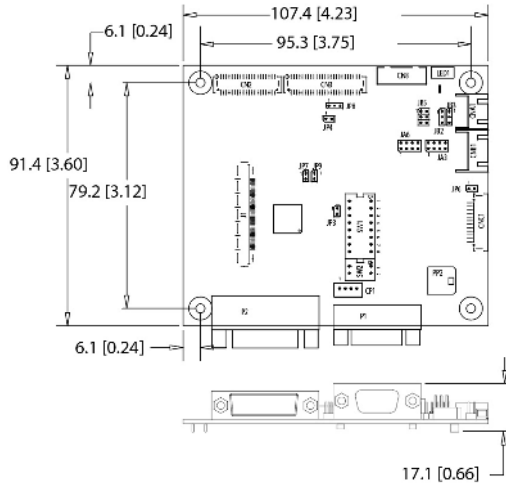

## Functions

- Display:** On Screen Display (OSD)
- Controls:** External buttons, Serial RS-232
- Image Control:** Brightness, Contrast, Sharpness, Clock, Phase, Color temperature, Image position, Gamma.
- Other:** Auto image adjust, Color auto adjust, Auto source seek, Input source select, Aspect ratio, OSD timeout, OSD menu position, OSD menu transparency.

## Accessories

- OSD Digital Button Board Kit 67110-3
- OSD Vertical Membrane Kit 67121-3
- OSD Horizontal Membrane Kit 67134-3
- Inverter Interface Board P/N 416040010-3

## Specifications - other:

- Colors:** 8 bit input / 8 bit panel support
- Panel Power:** 3.3V, 5V, 12V, 18V
- Input Power:** 12/24V DC +/- 5%, 10W
- Inverter Support:** DPMS enable (3.3V or 5V), PWM
- Plug & Play:** DDC 1, 2/b compatible
- Status indicator:** Dual color LED support
- MTBF:** over 100,000 hours
- RoHS compliant:** Yes
- Warranty:** 3 Years

## On the Website

[digitalview.com/controllers/alr-1400v2-lcd-controller.html](http://digitalview.com/controllers/alr-1400v2-lcd-controller.html)



## MIP-1000

Part No : 4160072xx-3



The MIP-1000 LCD controller board is a semi-customized interface for HDMI to MIPI input LCD panels

Features:

- » Up to 2160 x 3840 input / Up to 2160 x 3840 LCD panels
- » HDMI 1.4
- » MIPI DSI panel connection

### Panel Connection

MIPI DSI up to 2160 x 3840 @30Hz

Panel resolutions Most standard & custom resolutions up to 2160 x 3840

### Input Signal

HDMI 1.4 30Hz up to 2160 x 3840

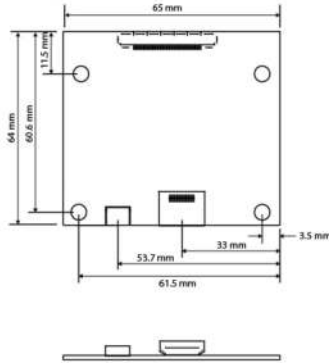

## Functions

**Image Control:** Brightness

## Accessories

Display interface board (subject to panel model)

## Specifications - other:

**Colors:** 8 bit input / 8 bit panel support

**Panel Power:** 1.8V, 3.3V, 5.8V,

**Input Power:** 5V DC +/- 5%

**Inverter Support:** PWM

**RoHS compliant:** Yes

**Warranty:** 3 Years

## On the Website

[digitalview.com/controllers/MIP-1000-lcd-controller.html](http://digitalview.com/controllers/MIP-1000-lcd-controller.html)



# HX-4096

Part No : 4175501xx-3

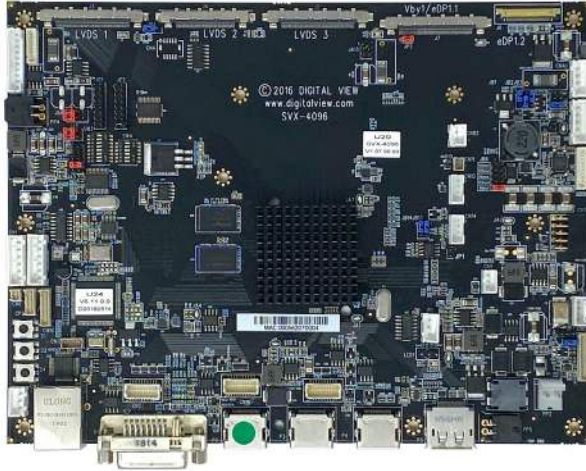

The HX-4096 is an advanced controller supporting LCD & OLED panels up to 4096 x 2160 resolution

## Features:

- » Up to 4096 x 2160 input, 10 bit / Up to 4096 x 2160 LCD panels, 10 bit
- » HDMI 2.0, HDMI 1.4 (x2), Displayport 1.2, DVI-I Dual Link
- » V-by-One, eDP, LVDS panel connection @60Hz/120Hz
- » Full frame memory buffer for enhanced image control
- » Ethernet, RS-232, Infra-red remote control, External buttons

## Panel Connection

|                             |  |
|-----------------------------|--|
| <b>V-by-One (8 channel)</b> | up to 4096 x 2160 @60Hz<br>add IE-2000 for 120Hz |
| <b>eDP (HBR/HBR2)</b>       | up to 4096 x 2160 @60Hz                          |
| <b>LVDS (8 channel)</b>     | up to 4096 x 2160 @60Hz                          |

|                          |  |
|--------------------------|--|
| <b>Panel resolutions</b> | 4096 x 2160, 3840 x 2160<br>1920 x 1200, 1920 x 1080 |
|--------------------------|--|

## Input Signal

|                        |  |
|------------------------|--|
| <b>HDMI 2.0</b>        | 60Hz up to 4096 x 2160<br>75Hz up to 1600 x 1200                           |
| <b>HDMI 1.4</b>        | 30Hz up to 4096 x 2160<br>60Hz up to 2560 x 1600<br>75Hz up to 1600 x 1200 |
| <b>Displayport 1.2</b> | 60Hz up to 4096 x 2160<br>75Hz up to 1600 x 1200                           |
| <b>DVI-I Dual Link</b> | 30Hz up to 4096 x 2160<br>60Hz up to 2560 x 1600<br>75Hz up to 1600 x 1200 |

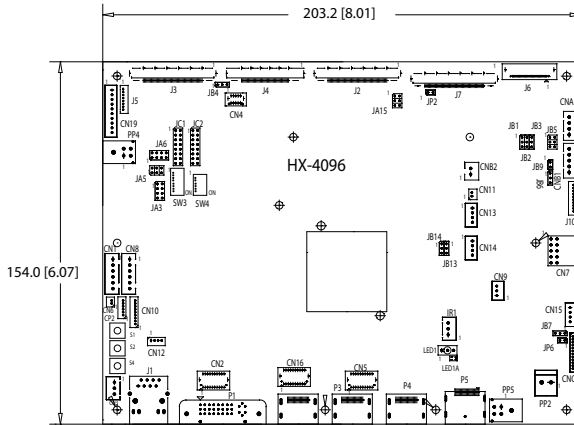

## Functions

**Display:** On Screen Display (OSD)

**Controls:** External buttons, Infra-Red, Serial RS-232, Ethernet

**Image Control:** Brightness, Contrast, Color Temperature, Image position, Saturation, Hue, Sharpness, Up/Down scaling to fit input to panel resolution

**Other:** System information, Scaling to fill screen and fill to aspect ratio, Programmable hot-keys, Factory reset, Quad input support, Picture in Picture (PiP), Picture by Picture (PbP), Ambient light sensor support, Enable frame buffer for FRC image enhancement, OSD menu transparency, DDC-CI support.

## Accessories

|                           |                    |
|---------------------------|--------------------|
| IE-2000, for 120Hz panels | P/N 4175600XX-3    |
| Inverter interface board  | [subject to panel] |
| IR remote control         | P/N 5590001XX-3    |
| OSD digital button board  | Kit 67110-3        |
| OSD membrane kit - Ver    | Kit 67134-3        |
| OSD membrane kit - Hor    | Kit 67135-3        |
| Audio Add-on board        | P/N 416940020-3    |

Note: Suitability for use in critical applications must be independently tested and verified by the user.

## Harsh Environment Features

Ceramic capacitors

Locking connectors for vibration tolerance

Operating compliance from -20°C to 80°C

Silicone based conformal coating

## Specifications - other

**Colors:** 10 bit input / 10 bit panel support

**Panel Power:** 3.3V, 5V, 10V, 12V, 18V

**Input Power:** 12/24V DC +/- 5%, 10W

**Inverter Support:** DPMS enable (3.3V or 5V), PWM

**Plug & Play:** DDC 1, 2/b compatible

**Status indicator:** Dual color LED support

**MTBF:** over 100,000 hours

**RoHS compliant:** Yes

**Warranty:** 3 Years

## On the Website

[digitalview.com/controllers/hx-4096-lcd-controller.html](http://digitalview.com/controllers/hx-4096-lcd-controller.html)



# HDT-4096

Part No : 4178201xx-3



The HDT-4096 controller for LCD panels up to 4096 x 2160 with HDMI, DVI-I (DVI & VGA) inputs,

#### Features:

- » Up to 4096 x 2160 input, 10 bit / Up to 4096 x 2160 LCD panels, 10 bit
- » HDMI ( x1), Displayport (x1)
- » V-by-One, eDP panel connection @60Hz refresh rate
- » RS-232 (Serial), Infra-red remote control, External buttons

## Panel Connection

**V-by-One** up to 4096 x 2160 @60Hz

**Panel resolutions** Most standard & custom resolutions up to 4096 x 2160

## Input Signal

**HDMI 2.0** 60Hz up to 4096 x 2160

**Displayport** 60Hz up to 1920 x 1200



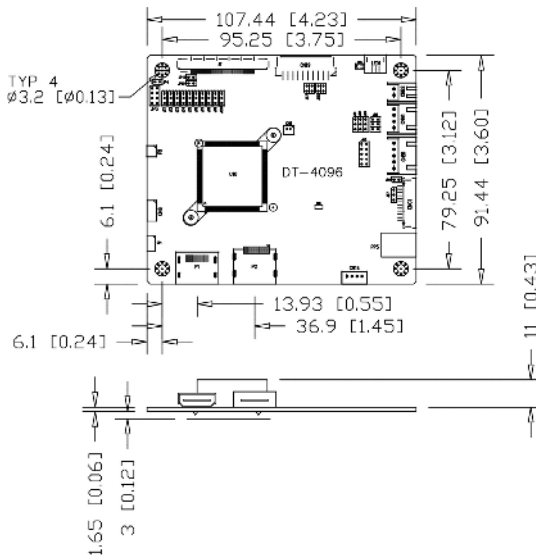

## Functions:

- Display:** On Screen Display (OSD)
- Controls:** External buttons, Infra-Red, Serial RS-232
- Main:** Backlight brightness, Contrast, Color Temperature, Saturation, Hue, Sharpness, Black level
- Other:** Input source select, Auto source seek, Display rotate, OSD position, OSD timeout, OSD menu transparency, Volume control, Programmable hotkeys, System Information, Image scaling - Up/Down scaling to fit input to panel resolution & aspect ratio. Load factory defaults.

**Conformal coating & Extended temperature tolerance.**

## Accessories

|                          |                 |
|--------------------------|-----------------|
| IE-2000 for 120Hz panels | 41775600xx-3    |
| OSD Digital Button Board | Kit 67110-3     |
| OSD Vertical Membrane    | Kit 67135-3     |
| OSD Horizontal Membrane  | Kit 67134-3     |
| Inverter Interface board | P/N 416040010-3 |
| IR Remote Control        | P/N 5590001XX-3 |

Note: Suitability for use in critical applications must be independently tested and verified by the user.

## Specifications - other:

- Colors:** 10 bit input / 10 bit panel support
- Panel Power:** 3.3V, 5V, 10V, 12V, 18V
- Input Power:** 12/24V DC +/- 5%, 4W
- Inverter Support:** DPMS enable (3.3V or 5V), PWM
- Plug & Play:** DDC 1, 2/b compatible
- Status indicator:** Dual color LED support
- MTBF:** over 100,000 hours
- RoHS compliant:** Yes
- Warranty:** 3 Years

## On the Website

[digitalview.com/controllers/hdt-4096-lcd-controller.html](http://digitalview.com/controllers/hdt-4096-lcd-controller.html)



# HX-2560-SDI

Part No : 4178000xx-3



## The HX-2560-SDI compact high resolution controller board with headers & SDI

### Features:

- » Up to 2560 x 1600 input, 10 bit / Up to 2560 x 1600 LCD panels, 10 bit
- » HDMI x 2, Displayport, Analog RGB (VGA), HD/SD-SDI
- » LVDS panel connection @60Hz refresh rate
- » Full frame memory buffer for enhanced image control
- » RS-232 (Serial), Infra-red remote control, External buttons

### Panel Connection

**LVDS (4 channel)** up to 2560 x 1600 @60Hz

**Panel resolutions** Most standard & custom resolutions up to 1920 x 1200

### Input Signal

**HDMI 1.4** 60Hz up to 1920 x 1200  
75Hz up to 1280 x 1024

**DVI-D** 60Hz up to 1920 x 1200  
75Hz up to 1280 x 1024

**ARGB (VGA)** 60Hz up to 1920 x 1200  
75Hz up to 1280 x 1024

**Component** 720p, 1080i, 1080p

**3G-SDI** \*available as an option with HD-3000S or HD-1000P add-on board

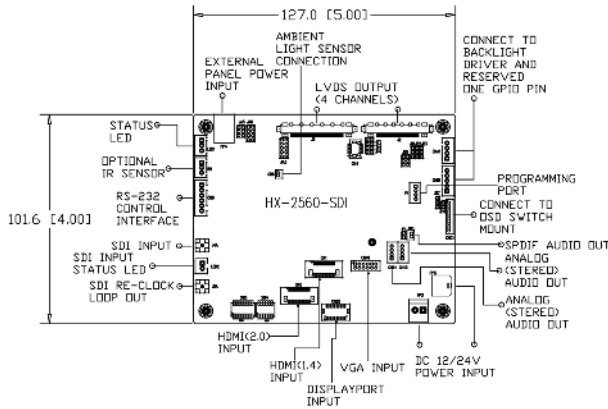

## Functions:

**Display:** On Screen Display (OSD)

**Controls:** External buttons, Infra-Red, Serial RS-232,

**Image Control:** Auto configuration, Brightness, Contrast, Black level, Aspect ratio, Clock, Phase, Color, Temperature, Image position, Saturation, Hue, Gamma

**Other:** System Information, OSD position, Scaling to fill screen and fill to aspect ratio, OSD timeout, Factory reset, Image flip, Picture in Picture variable position with 5 size selections and Picture by Picture, Programmable hot keys. Support for options such as ambient light sensor. Fast input switching. Language. Volume.

## Accessories

3G-SDI Adaptor HD-3000S P/N 4160164xx-3

|                      |                 |
|----------------------|-----------------|
| IR Remote Control    | P/N 5590001XX-3 |
| OSD Button Board     | Kit 67110-3     |
| OSD Membrane Kit Hor | Kit 67134-3     |
| OSD Membrane Kit Ver | Kit 67135-3     |
| Power Input Cable    | P/N 426013800-3 |
| Power Supply         | Kit 80100-3     |

Note: Suitability for use in critical applications must be independently tested and verified by the user.

## Harsh Environment Features

- » Ceramic capacitors
- » Locking connectors for vibration tolerance
- » Silicone based conformal coating
- » Operating compliance from -40°C to 80°C

## Specifications - other:

**Colors:** 10 bit input / 10 bit panel support

**Panel Power:** 3.3V, 5V, 10V, 12V, 18V

**Input Power:** 12V DC +/- 5%, 4W

**Inverter Support:** DPMS enable (3.3V or 5V), PWM

**Plug & Play:** DDC 1, 2/b compatible

**Status indicator:** Dual color LED support

**MTBF:** over 100,000 hours

**RoHS compliant:** Yes

**Warranty:** 3 Years

## On the Website

[digitalview.com/controllers/hx-2560-sdi-lcd-controller.html](http://digitalview.com/controllers/hx-2560-sdi-lcd-controller.html)



# HX-1920-PRO

Part No : 4177301xx-3



## The HX-1920-PRO replaces the HX-1920v3 & HE-1920v2

### Features:

- » Up to 1920 x 1200 input, 10 bit / Up to 1920 x 1200 LCD panels, 10 bit
- » HDMI, Displayport, DVI-I (DVI-D & VGA)
- » LVDS panel connection @60Hz refresh rate
- » Full frame memory buffer for enhanced image control
- » RS-232 (Serial), Infra-red remote control, External buttons

## Panel Connection

**LVDS (2 channel)** up to 1920 x 1200 @60Hz

**Panel resolutions** Most standard & custom resolutions up to 1920 x 1200

## Input Signal

**HDMI 1.4** 60Hz up to 1920 x 1200  
1080p, 1080i, 720p,  
576p, 480p

**Displayport** 60Hz up to 1920 x 1200  
1080p, 1080i, 720p,  
576p, 480p

**DVI-I (ARGB)** 60Hz up to 1920 x 1200  
75Hz up to 1280 x 1024

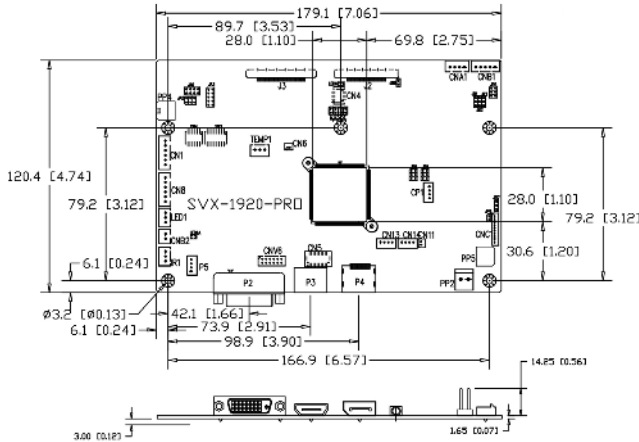

## Functions

**Display:** On Screen Display (OSD)

**Controls:** External buttons, Infra-Red, Serial RS-232

**Image Control:** Brightness, Contrast, Color Temperature, Black level, Gamma, Image position, Saturation, Hue, Sharpness, Up/Down scaling to fit input to panel resolution

**Other:** System Information, OSD position, Scaling to fill screen and fill to aspect ratio, OSD timeout, Factory reset, OSD menu transparency, Horizontal & Vertical image inversion, Picture in Picture (PiP) variable position & any input combination (18 sizes), Picture-by-Picture, Programmable hot keys, Serial port protocol, Ambient light sensor support. Fast input port switching.

## Accessories

|                          |                 |
|--------------------------|-----------------|
| OSD Digital Button Board | Kit 67110-3     |
| OSD Vertical Membrane    | Kit 67135-3     |
| OSD Horizontal Membrane  | Kit 67134-3     |
| Inverter Interface Board | P/N 416040010-3 |
| Audio Amplifier          | P/N 416940020-3 |
| IR Remote Control        | P/N 5590001XX-3 |

Note: Suitability for use in critical applications must be independently tested and verified by the user.

## Harsh Environment Features

- » Ceramic capacitors
- » Locking connectors for vibration tolerance
- » Silicone based conformal coating
- » Operating compliance from -40°C to 80°C

## Specifications - other

**Colors:** 10 bit input / 10 bit panel support

**Panel Power:** 3.3V, 5V, 10V, 12V, 18V

**Input Power:** 12/24V DC +/- 5%, 2.5W

**Inverter Support:** DPMS enable (3.3V or 5V), PWM

**Plug & Play:** DDC 1, 2/b compatible

**Status indicator:** Dual color LED support

**MTBF:** over 100,000 hours

**RoHS compliant:** Yes

**Warranty:** 3 Years

## On the Website

[digitalview.com/controllers/hx-1920-pro-lcd-controller.html](http://digitalview.com/controllers/hx-1920-pro-lcd-controller.html)



# HLT-1920

Part No : 4176401xx-3



The HLT-1920 is a compact controller for LCD panels up to 1920 x 1200 with HDMI, Displayport & ARGB inputs

**Features:**

- » Up to 1920 x 1200 input, 8 bit / Up to 1920 x 1200 LCD panels, 8 bit
- » HDMI, Displayport, Analog RGB (VGA)
- » LVDS panel connection @60Hz refresh rate
- » RS-232 (Serial), Infra-red remote control, External buttons

## Panel Connection

**LVDS (2 channel)** up to 1920 x 1200 @60Hz

**Panel resolutions** Most standard & custom resolutions up to 1920 x 1200

## Input Signal

**HDMI** 60Hz up to 1920 x 1200

**Displayport** 60Hz up to 1920 x 1200

**ARGB (VGA)** 60Hz up to 1920 x 1200

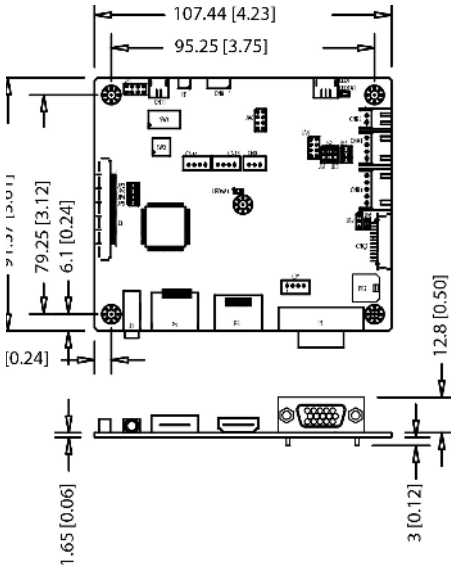

## Harsh Environment Features

- » Ceramic capacitors
- » Locking connectors for vibration tolerance
- » Silicone based conformal coating
- » Operating compliance from -40°C to 80°C

## Functions:

- Display:** On Screen Display (OSD)  
**Controls:** External buttons, Infra-Red, Serial RS-232  
**Image Control:** Brightness, Contrast, Sharpness, Clock, Phase, Color temperature, Image position, Gamma, Sharpness  
**Other:** Auto picture setup, Auto RGB calibration, Auto source seek, OSD timeout, OSD position, OSD menu rotation, OSD transparency, Select input source, Volume control, Load factory defaults

## Accessories

|                          |                 |
|--------------------------|-----------------|
| OSD Digital Button Board | Kit 67110-3     |
| OSD Vertical Membrane    | Kit 67135-3     |
| OSD Horizontal Membrane  | Kit 67134-3     |
| Inverter Interface board | P/N 416040010-3 |
| IR Remote Control        | P/N 5590001XX-3 |

## Specifications - other:

- Colors:** 8 bit input / 8 bit panel support  
**Panel Power:** 3.3V, 5V, 12V  
**Input Power:** 12V DC +/- 5%, 10W  
**Inverter Support:** DPMS enable (3.3V or 5V), PWM  
**Plug & Play:** DDC 1, 2/b compatible  
**Status indicator:** Dual color LED support  
**MTBF:** over 100,000 hours  
**RoHS compliant:** Yes  
**Warranty:** 3 Years

## On the Website

[digitalview.com/controllers/hlt-1920-lcd-controller.html](http://digitalview.com/controllers/hlt-1920-lcd-controller.html)



Note: Suitability for use in critical applications must be independently tested and verified by the user.

# HE-1400v2

Part No : 4175801xx-3



The HE-1400v2 is a compact LCD controller supporting LCD panels up to 1440 x 900 resolution with TTL and LVDS connection

**Features:**

- » Up to 1366 x 768 input, 8 bit / Up to 1440 x 900 LCD panels, 8 bit
- » DVI-D, Analog RGB (VGA)
- » LVDS & TTL panel connection @60Hz refresh rate
- » RS-232 (Serial), External buttons

## Panel Connection

**LVDS (2 channel)** up to 1440 x 900 @60Hz  
**TTL** up to 1440 x 900 @60Hz

**Panel resolutions** Most standard & custom resolutions up to 1440 x 900

## Input Signal

**DVI-D** 60Hz up to 1366 x 768

**ARGB (VGA)** 60Hz up to 1366 x 768



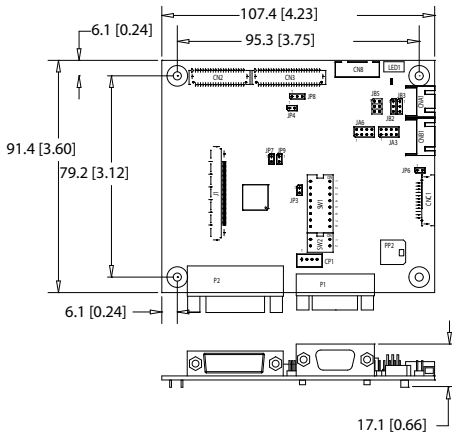

## Harsh Environment Features

- » Ceramic capacitors
- » Locking connectors for vibration tolerance
- » Acrylic resin conformal coating
- » Operating compliance from -40°C to 80°C

## Functions:

**Display:** On Screen Display (OSD)

**Controls:** External buttons, Serial RS-232

**Image Control:** Brightness, Contrast, Sharpness, Clock, Phase, Color temperature, Image position, Gamma.

**Other:** Auto image adjust, Color auto adjust, Auto source seek, Input source select, Aspect ratio, OSD timeout, OSD menu position, OSD menu transparency.

## Accessories

|                          |                 |
|--------------------------|-----------------|
| OSD Digital Button Board | Kit 67110-3     |
| OSD Vertical Membrane    | Kit 67121-3     |
| OSD Horizontal Membrane  | Kit 67134-3     |
| Inverter Interface Board | P/N 416040010-3 |

## Specifications - other:

**Colors:** 8 bit input / 8 bit panel support

**Panel Power:** 3.3V, 5V, 12V, 18V

**Input Power:** 12V DC +/- 5%, 10W

**Inverter Support:** DPMS enable (3.3V or 5V), PWM

**Plug & Play:** DDC 1, 2/b compatible

**Status indicator:** Dual color LED support

**MTBF:** over 100,000 hours

**RoHS compliant:** Yes

**Warranty:** 3 Years

## On the Website

[digitalview.com/controllers/he-1400v2-lcd-controller.html](http://digitalview.com/controllers/he-1400v2-lcd-controller.html)

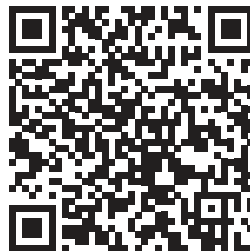

Note: Suitability for use in critical applications must be independently tested and verified by the user.

# EPM-100v2

Part No : 4160239xx-3



## The EPM-100v2 is a driver board for E Ink 32” and 42” monochrome epaper panels

The EPM-100v2 accepts bitmap (BMP) images transferred over USB in the suitable format, then writes these to the E Ink panel.

### Panel Connection

**E Ink** 32” and 42” monochrome

**Panel resolutions** 32” 2560 x 1440  
42” 2880 x 2160

### Input Signal

**USB** 60Hz up to 1920 x 1200

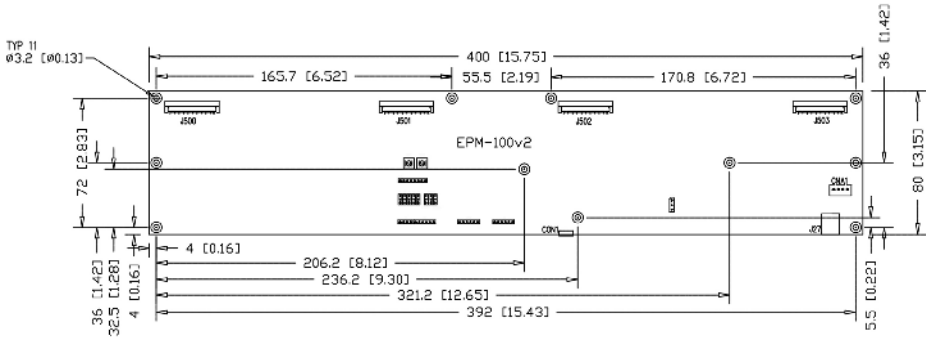

## Functions:

**Controls:** External buttons, Infra-Red, Serial RS-232

**Control:** Image rotation: 0/90/180/270 degrees, Image mirror, Image flip, Built-in temperature sensor

## Accessories

USB cable, Media player, Ambient light sensor

## Specifications - other:

**Colors:** 16 bit monochrome

**Input Power:** 12V DC +/- 5%, 10W

**Status indicator:** Dual color LED support

**MTBF:** over 100,000 hours

**RoHS compliant:** Yes

**Warranty:** 3 Years

## On the Website

[www.digitalview.com/controllers/epm-100v2-eink-interface.html](http://www.digitalview.com/controllers/epm-100v2-eink-interface.html)

Note: Suitability for use in critical applications must be independently tested and verified by the user.



## Functions:

**Controls:** External buttons, Infra-Red, Serial RS-232

**Control:** Image rotation: 0/90/180/270 degrees, Image mirror, Image flip, Built-in temperature sensor

## Accessories

USB cable, Media player, Ambient light sensor

## Specifications - other:

**Input Power:** 12V DC +/- 5%, 10W

**Status indicator:** Dual color LED support

**MTBF:** over 100,000 hours

**RoHS compliant:** Yes

**Warranty:** 3 Years

Note: Suitability for use in critical applications must be independently tested and verified by the user.

# EPM-050

Part No : 4160245xx-3



## The EPM-050 is a driver board for E Ink 13.3” monochrome epaper panels

The EPM-050 accepts bitmap (BMP) images transferred over USB in the suitable format, then writes these to the E Ink panel.

### Panel Connection

E Ink 13.3 mono 1600 x 1200

### Input Signal

Micro USB

Bitmap images to 16 bit gray scale.

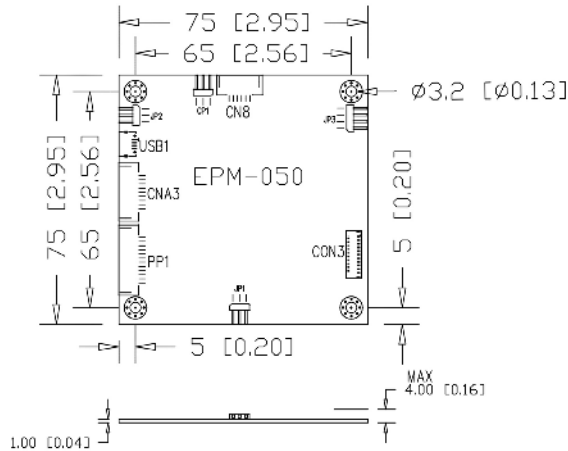

## Functions:

**Display:** On Screen Display (OSD) of certain functions such as image write and write complete.

## Accessories

USB cable  
Media player  
Optical bonded coverglass  
Ambient light sensor & A/D

## Specifications - other:

**Colors:** 16 bit monochrome  
**Input Power:** 12V DC +/- 5%  
**Status indicator:** Dual color LED support  
**MTBF:** over 200,000 hours  
**RoHS compliant:** Yes  
**Warranty:** 3 Years

## On the Website

[www.digitalview.com/controllers/epm-050-eink-interface.html](http://www.digitalview.com/controllers/epm-050-eink-interface.html)



Note: Suitability for use in critical applications must be independently tested and verified by the user.

## Accessories

Digital View provides a comprehensive range of accessories to complement most controllers. We provide solutions to enhance user interface, aid in remote problem solving, enable system differentiation and customization. More importantly, these accessories enable customers to build a better product solution.

Please see more information at [www.digitalview.com/products/lcd-controller-accessories](http://www.digitalview.com/products/lcd-controller-accessories)

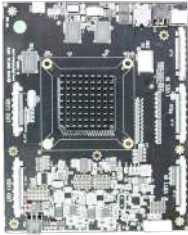

### 120Hz Panel Interface: IE-2000

IE-2000 is designed for the SVX-4096 and adds support for 120Hz panels with V-by-One connectivity.

IE-2000 P/N 4175600xx-3

---

## Composite Video Input Adaptor



### AVD-2000 New model

AVD-1000 P/N: 4160187xx-3 | KIT-71300-3

HVD-1000 P/N: 4160188xx-3 | KIT-71301-3

The AVD-2000 is a new model scheduled for mid 2019 to replace the AVD-1000. Design is similar, board size is the same. Added capabilities include delinterlacing and faster source switching.

The AVD-1000 features two Composite video and two S-video inputs. It can also be custom assembled with four Composite inputs. There is also an HDMI output, type A connector, enabling stand-alone use. When used with a Digital View LCD controller, the OSD menu and Ethernet/RS-232 command set will provide input selection and other related functions.

The HVD-1000 is a Harsh Environment version.



## SDI, HD-SDI, 3G-SDI



### HD-3000S & HD-3000

Single & Dual Channel HD-SDI Adapter

1. Supports 1.5Gbits & 3Gbits bit rate
2. Single channels input port supported
3. HD-SDI re-clock loop through output
4. HDMI (v1.3) x 1 output port
5. Stereo embedded audio support
6. On-board power on/off switch
7. AFD (Active Format Description) support
8. Fully compliant with SMPTE 292M, 259M-C, 424M, 425M.

Single Channel      HD-3000S P/N: 4160164xx-3

Dual Channel        HD-3000 P/N: 4160160xx-3

On-Screen Menu Buttons | Various - see website

A selection of buttons to access the on-screen menu functions. Includes both mechanical click type and membrane type.

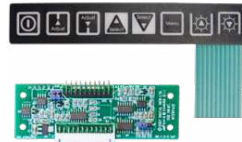
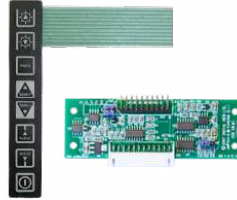
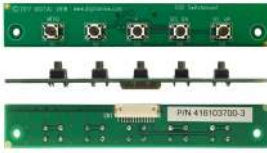

Ethernet Interface: IP-60v2 | P/N 4160137xx-3



The IP-60 is a network device that allows you to control RS-232 enabled devices over a TCP/IP based Ethernet and the Internet using a web browser.

The IP-60 features an embedded Web Console Program (WCP) that allows developers to change command settings and make their own web pages.



Audio Add-on board | Ask for details

An easy to use accessory to add audio capability directly to your display system.



### Ambient Light Sensor: Autobrite+ | KIT-70307-3

Designed to work with any Digital View controller, this board provides auto-adjustment to the controllers backlight level (value 10-100) to match the brightness coming into the sensor. Monitoring the levels every 10 seconds, the Autobrite+ communicates with the controller through the serial port while allowing parallel communication of serial commands to the controller through the board. The four available outputs allow support for additional controllers.



### IR/LED Board | P/N 416015300-3 ( Kit 70221-3)

The IR board is one of those small accessories that sometimes gets overlooked but plays a valuable role. This board is designed to be integrated on the inside of an enclosure with suitable access holes. The IR receiver is used for the On Screen Display (OSD) menu of Digital View display interface controllers and works with the Digital View remote control. The LED is the controller power indicator.



### IR Remote Control | P/N 5590001xx-3

The Digital View Remote control unit is compatible with all DV controller products. It is provided with universal control buttons that enable the control of OSD functions plus TV and media playback on DV media products. The IR sensor and cable kit is required.

### IR Control Device

This new IR control device provides a method of having single button port selections from the IR remote. For example, #1 always selects the DVI port while #4 selects the Composite 1 port.

## Also available

### Bluetooth Interface

Provides a smartphone interface for controller/display menu functions.

### USB Switcher

A USB 'follow-me' solution so a touch-screen USB connection matches the video input source from laptops and other video sources.

### Software & Apps

Windows, Android and IOS applications to enhance the functionality of monitors.

See all Accessories at: [www.digitalview.com/accessories/accessories.html](http://www.digitalview.com/accessories/accessories.html)



#### USA

18440 Technology Drive, Morgan Hill, CA 95037, USA  
t : +1 408-782-7773

**DIGITALVIEW®**  
■ ■ ■ ■ ■ ■ ■ ■

[www.digitalview.com](http://www.digitalview.com)

#### EUROPE

The Lake House, Knebworth Park, Herts, SG3 6PY, UK  
t : +44 (0) 20-7631-2150

#### ASIA

705-708, 7/F Texwood Plaza, 6 How Ming St, Kwun Tong,  
Kowloon, Hong Kong  
t : +(852) 2861-3615

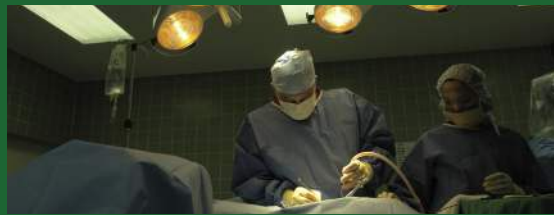

Details subject to change without notice