

Description

The AS78LXX series are three terminal positive regulators designed for a wide variety of applications including local, on-card regulation.

This series of regulators are complete with internal current limiting, thermal shutdown protection, and safe-area compensation which make them virtually immune from output overload. If adequate heat sinking are provided, these regulators can deliver output currents up to 100mA.

The AS78LXX series are available in TO-92 (bulk or ammo packing), SOT-89 and SOIC-8 packages.

Features

- Output Current up to 100mA
- Fixed Output Voltages of 5V, 12V and 15V
- Output Voltage Accuracy of $\pm 5\%$ over the Full Temperature Range
- Internal Short Circuit Current Limiting
- Internal Thermal Overload Protection
- No External Components
- Output Transistor Safe-Area Protection

Applications

- Consumer Electronics
- Microprocessor Power Supplies
- Mother Boards

Pin Assignments

Z Package
(TO-92(Bulk Packing))

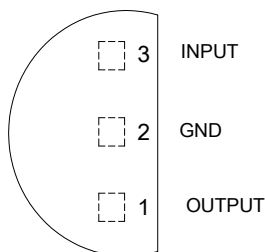

Z Package
(TO-92(Ammo Packing))

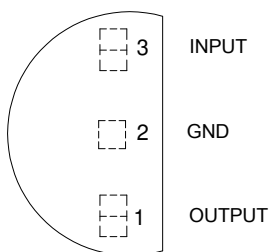

R Package
(SOT-89 Option 1)

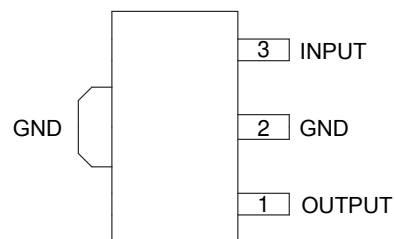

R Package
(SOT-89 Option 2)

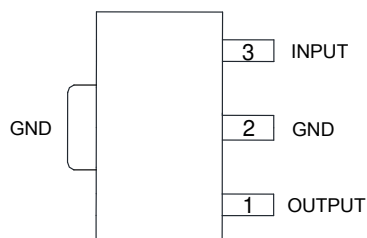

M Package
(SOIC-8)

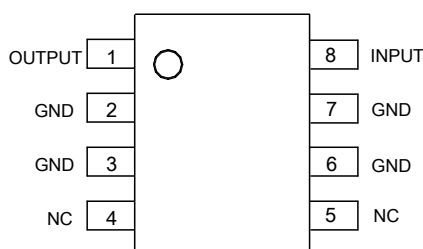

Typical Applications Circuit

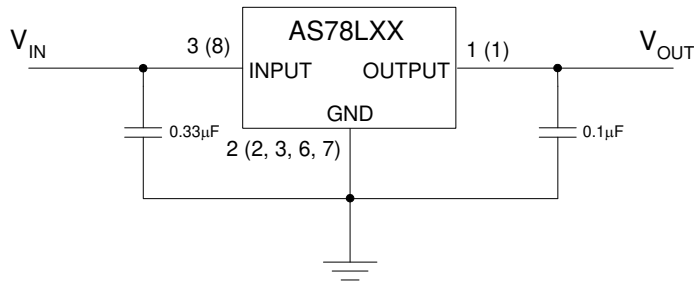

A (B)
A for 3-pin B for 8-pin

Functional Block Diagram

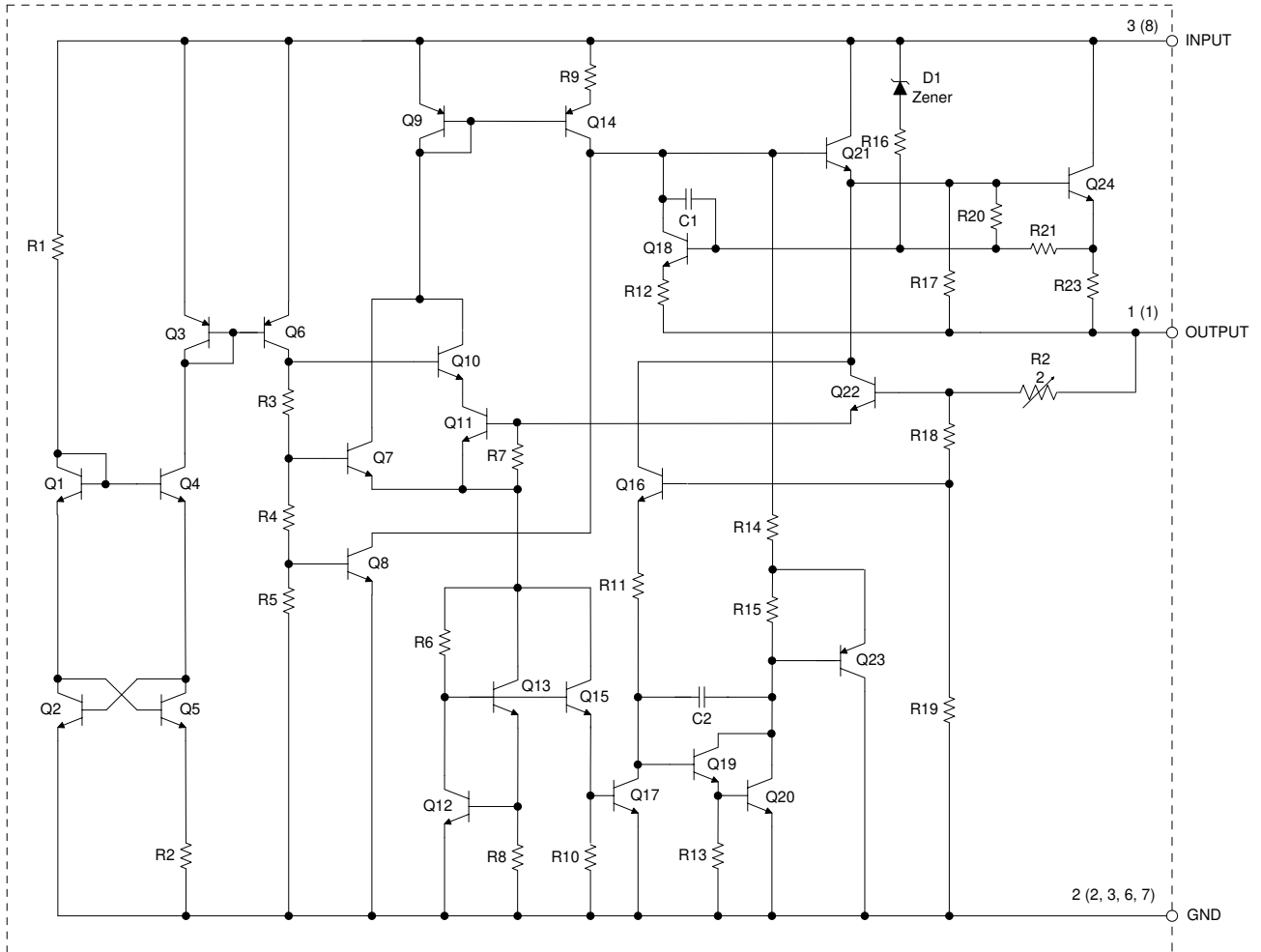

A (B)
A for 3-pin B for 8-pin

Absolute Maximum Ratings (Note 1)

Symbol	Parameter	Rating	Unit
V _{IN}	Input Voltage	36	V
T _J	Operating Junction Temperature	150	°C
T _{LEAD}	Lead Temperature (Soldering, 10sec)	260	°C
P _D	Power Dissipation	750	mW
T _{STG}	Storage Temperature Range	-65 to +150	°C
θ _{JA}	Thermal Resistance	TO-92	+180
ESD	ESD (Human Body Model)	2000	V
ESD	ESD (Machine Model)	200	V

Note. 1. Stresses greater than those listed under “Absolute Maximum Ratings” may cause permanent damage to the device. These are stress ratings only, and functional operation of the device at these or any other conditions beyond those indicated under “Recommended Operating Conditions” is not implied. Exposure to “Absolute Maximum Ratings” for extended periods may affect device reliability.

Recommended Operating Conditions

Symbol	Parameter	Min	Max	Unit
V _{IN}	Input Voltage	AS78L05	30	V
		AS78L12	36	
		AS78L15	36	
T _J	Operating Junction Temperature Range	-40	+125	°C

Electrical Characteristics

AS78L05 (@ V_{IN} = 10V, I_{OUT} = 40mA, C_{IN} = 0.33μF, C_{OUT} = 0.1μF, T_J = +25°C, **Bold** typeface applies over -40°C ≤ T_J ≤ +125°C, unless otherwise specified.)

Symbol	Parameter	Conditions	Min	Typ	Max	Unit
V _{OUT}	Output Voltage		4.8	5.0	5.2	V
		7V ≤ V _{IN} ≤ 20V, 1mA ≤ I _{OUT} ≤ 100mA, P _D ≤ 0.75W	4.75		5.25	
V _{RLINE}	Line Regulation	7V ≤ V _{IN} ≤ 20V		8	150	mV
V _{RLOAD}	Load Regulation	1mA ≤ I _{OUT} ≤ 100mA		10	60	mV
I _Q	Quiescent Current			3	5.5	mA
ΔI _Q	Quiescent Current Change	8V ≤ V _{IN} ≤ 20V			1.5	mA
		1mA ≤ I _{OUT} ≤ 40mA			0.1	
PSRR	Ripple Rejection	f = 120Hz, 8V ≤ V _{IN} ≤ 18V	47	62		dB
V _{DROP}	Dropout Voltage	I _{OUT} = 40mA		1.7	2.0	V
		I _{OUT} = 100mA		1.8	2.3	
N _O	Output Noise Voltage	10Hz ≤ f ≤ 100kHz (Note 2)		40		μV
ΔV _{OUT} /ΔT	Output Voltage Temperature Coefficient	I _{OUT} = 5mA		0.42		mV/°C
(ΔV _{OUT} /V _{OUT})/□ ΔT				84		ppm/°C
θ _{JC}	Thermal Resistance	TO-92		40		°C/W
		SOT-89		28.3		
		SOIC-8		62		

Note: 2. 0.01μF minimum load capacitance is recommended to limit high frequency noise.

Electrical Characteristics (cont.)

AS78L05C (@ $V_{IN} = 10V$, $I_{OUT} = 40mA$, $C_{IN} = 0.33\mu F$, $C_{OUT} = 0.1\mu F$, $T_J = +25^\circ C$, **Bold** typeface applies over $-40^\circ C \leq T_J \leq +125^\circ C$, unless otherwise specified.)

Symbol	Parameter	Conditions	Min	Typ	Max	Unit
V_{OUT}	Output Voltage		5.0		5.1	V
V_{RLINE}	Line Regulation	$7V \leq V_{IN} \leq 20V$		8	150	mV
V_{RLOAD}	Load Regulation	$1mA \leq I_{OUT} \leq 100mA$		10	60	mV
I_Q	Quiescent Current			3	5.5	mA
ΔI_Q	Quiescent Current Change	$8V \leq V_{IN} \leq 20V$			1.5	mA
		$1mA \leq I_{OUT} \leq 40mA$			0.1	
PSRR	Ripple Rejection	$F = 120Hz$, $8V \leq V_{IN} \leq 18V$	47	62		dB
V_{DROP}	Dropout Voltage	$I_{OUT} = 40mA$		1.7		V
		$I_{OUT} = 100mA$		1.8		
N_O	Output Noise Voltage	$10Hz \leq f \leq 100kHz$ (Note 2)		40		μV
$\frac{\Delta V_{OUT}}{\Delta T}$	Output Voltage Temperature Coefficient	$I_{OUT} = 5mA$		0.42		mV/ $^\circ C$
$\frac{(\Delta V_{OUT}/V_{OUT})/\square}{\Delta T}$				84		ppm/ $^\circ C$
θ_{JC}	Thermal Resistance	TO-92		40		$^\circ C/W$
		SOT-89		28.3		
		SOIC-8		62		

 Note: 2. 0.01 μF minimum load capacitance is recommended to limit high frequency noise.

Electrical Characteristics (cont.)

AS78L12 (@ $V_{IN} = 19V$, $I_{OUT} = 40mA$, $C_{IN} = 0.33\mu F$, $C_{OUT} = 0.1\mu F$, $T_J = +25^\circ C$, **Bold** typeface applies over $-40^\circ C \leq T_J \leq +125^\circ C$, unless otherwise specified.)

Symbol	Parameter	Conditions	Min	Typ	Max	Unit
V_{OUT}	Output Voltage		11.5	12.0	12.5	V
		$14.5V \leq V_{IN} \leq 27V$, $1mA \leq I_{OUT} \leq 100mA$, $P_D \leq 0.75W$	11.4		12.6	
V_{RLINE}	Line Regulation	$14.5V \leq V_{IN} \leq 27V$		20	250	mV
V_{RLOAD}	Load Regulation	$1mA \leq I_{OUT} \leq 100mA$		20	100	mV
I_Q	Quiescent Current			3	6	mA
ΔI_Q	Quiescent Current Change	$16V \leq V_{IN} \leq 27V$			1.5	mA
		$1mA \leq I_{OUT} \leq 40mA$			0.1	
PSRR	Ripple Rejection	$f = 120Hz$, $15V \leq V_{IN} \leq 25V$	37	42		dB
V_{DROP}	Dropout Voltage	$I_{OUT} = 40mA$		1.7		V
		$I_{OUT} = 100mA$		1.8		
N_O	Output Noise Voltage	$10Hz \leq f \leq 100kHz$ (Note 2)		80		μV
$\frac{\Delta V_{OUT}}{\Delta T}$	Output Voltage Temperature Coefficient	$I_{OUT} = 5mA$		1		mV/ $^\circ C$
$\frac{(\Delta V_{OUT}/V_{OUT})/\square}{\Delta T}$				84		ppm/ $^\circ C$
θ_{JC}	Thermal Resistance	TO-92		40		$^\circ C/W$
		SOT-89		28.3		
		SOIC-8		62		

 Note: 2. 0.01 μF minimum load capacitance is recommended to limit high frequency noise.

Electrical Characteristics (cont.)

AS78L15 (@ $V_{IN} = 23V$, $I_{OUT} = 40mA$, $C_{IN} = 0.33\mu F$, $C_{OUT} = 0.1\mu F$, $T_J = +25^\circ C$, **Bold** typeface applies over $-40^\circ C \leq T_J \leq +125^\circ C$, unless otherwise specified.)

Symbol	Parameter	Conditions	Min	Typ	Max	Unit
V_{OUT}	Output Voltage		14.4	15.0	15.6	V
		$17.5V \leq V_{IN} \leq 30V$, $1mA \leq I_{OUT} \leq 100mA$, $P_D \leq 0.75W$	14.25		15.75	
V_{RLINE}	Line Regulation	$17.5V \leq V_{IN} \leq 30V$		25	250	mV
V_{RLOAD}	Load Regulation	$1mA \leq I_{OUT} \leq 100mA$		25	150	mV
I_Q	Quiescent Current			3	6	mA
ΔI_Q	Quiescent Current Change	$20V \leq V_{IN} \leq 30V$			1.5	mA
		$1mA \leq I_{OUT} \leq 40mA$			0.1	
PSRR	Ripple Rejection	$f = 120Hz$, $18.5V \leq V_{IN} \leq 28.5V$	34	39		dB
V_{DROP}	Dropout Voltage	$I_{OUT} = 40mA$		1.7		V
		$I_{OUT} = 100mA$		1.8		
N_O	Output Noise Voltage	$10Hz \leq f \leq 100kHz$ (Note 2)		90		μV
$\frac{\Delta V_{OUT}}{\Delta T}$	Output Voltage Temperature Coefficient	$I_{OUT} = 5mA$		1.25		mV/ $^\circ C$
$(\frac{\Delta V_{OUT}}{V_{OUT}}) / \Delta T$				84		ppm/ $^\circ C$
θ_{JC}	Thermal Resistance	TO-92		40		$^\circ C/W$
		SOT-89		28.3		
		SOIC-8		62		

Note: 2. 0.01 μF minimum load capacitance is recommended to limit high frequency noise.

Performance Characteristics

Output Voltage vs. Input Voltage

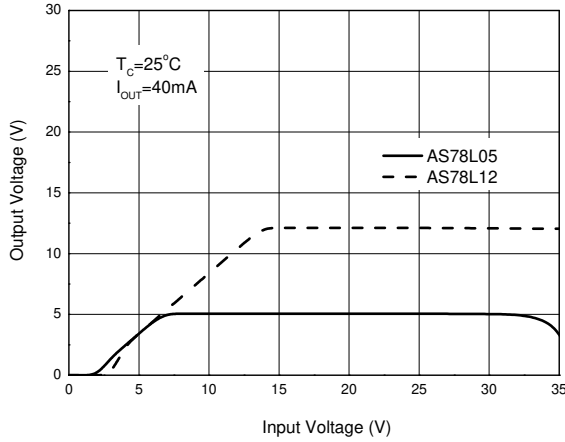

Output Voltage vs. Case Temperature

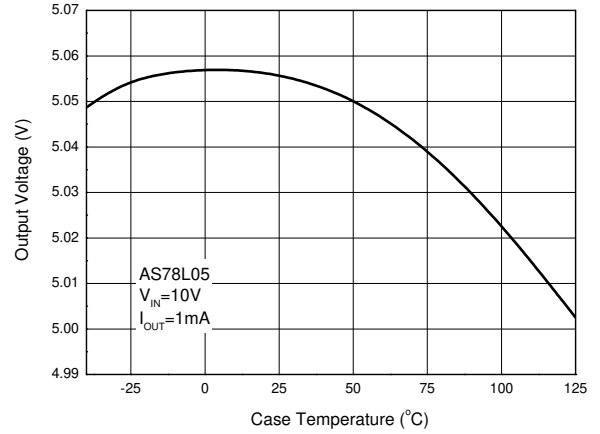

Over Temperature Protection

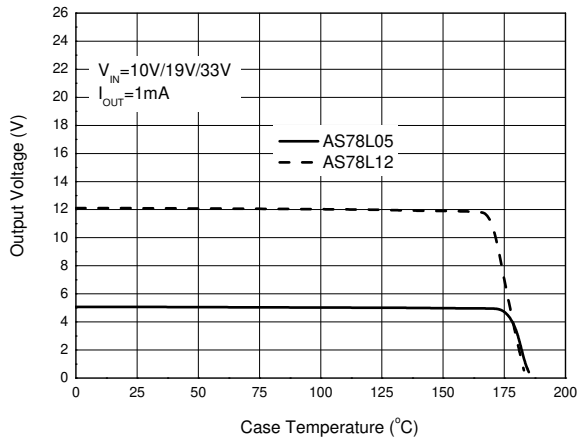

Dropout Voltage vs. Case Temperature

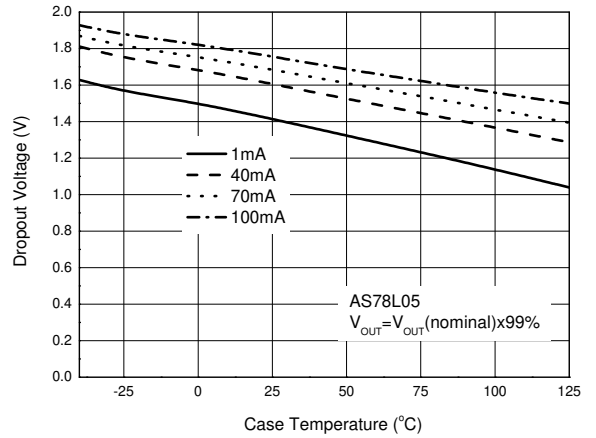

Output Voltage vs. Output Current

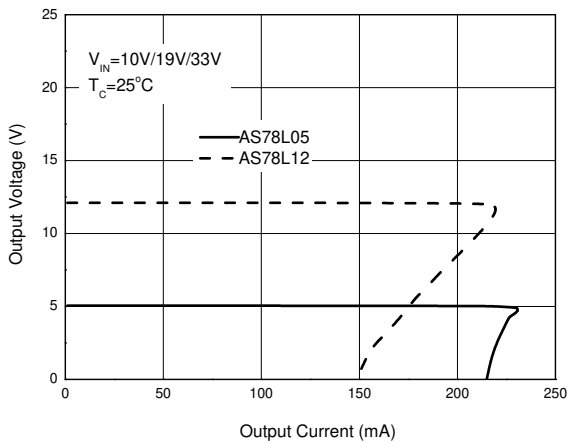

Quiescent Current vs. Case Temperature

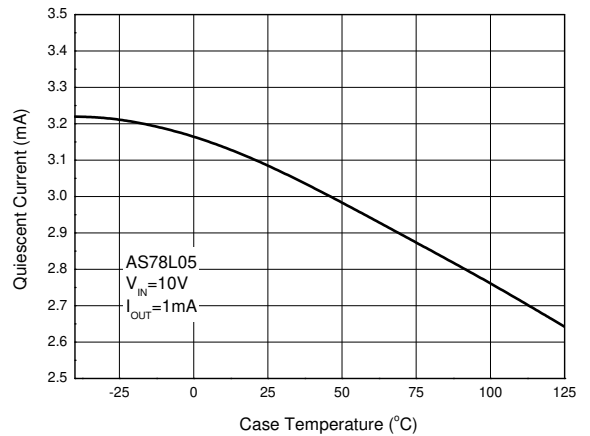

Performance Characteristics (cont.)

Power Dissipation vs. Case Temperature

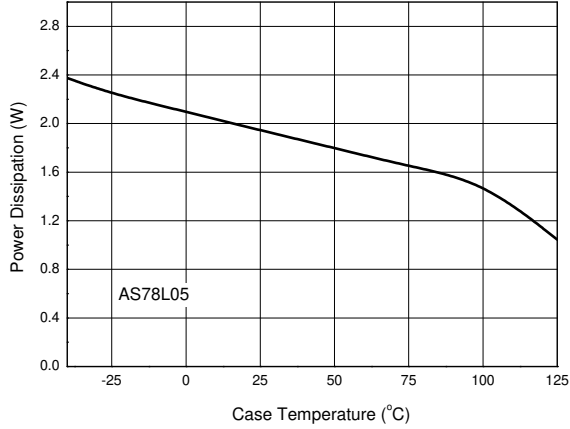

PSRR vs. Frequency

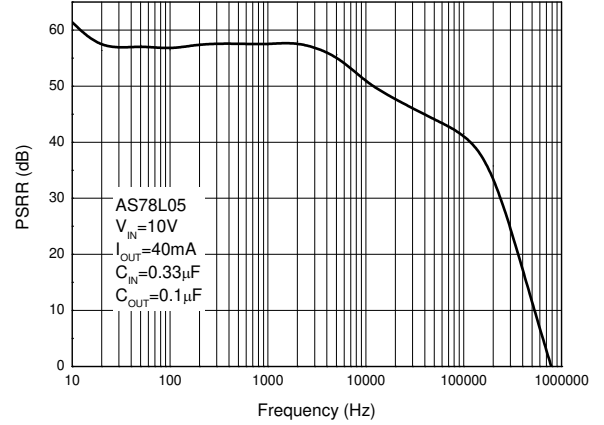

Line Transient
(Conditions: $I_{OUT}=40mA$, $C_{IN}=0.33\mu F$, $C_{OUT}=0.1\mu F$)

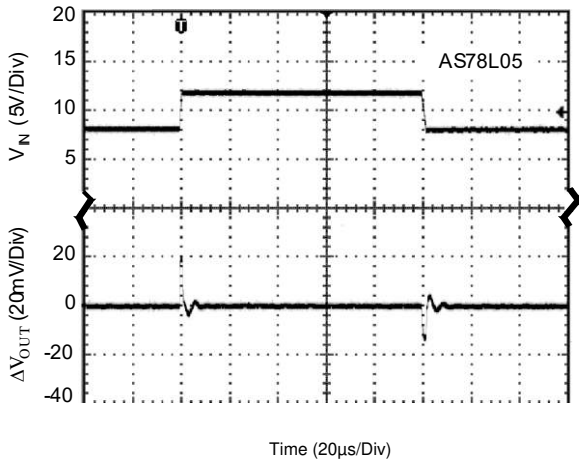

Load Transient
(Conditions: $V_{IN}=10V$, $C_{IN}=0.33\mu F$, $C_{OUT}=0.1\mu F$)

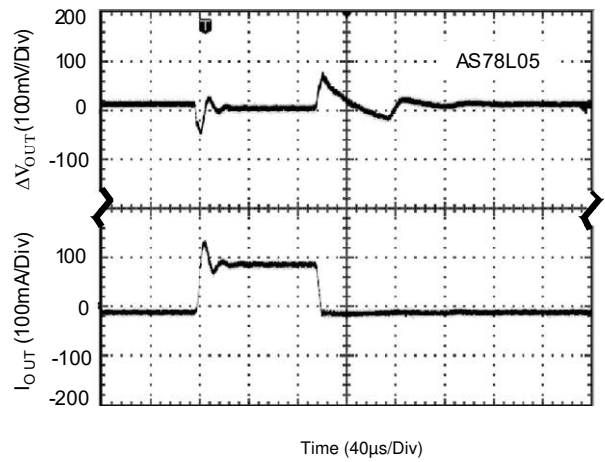

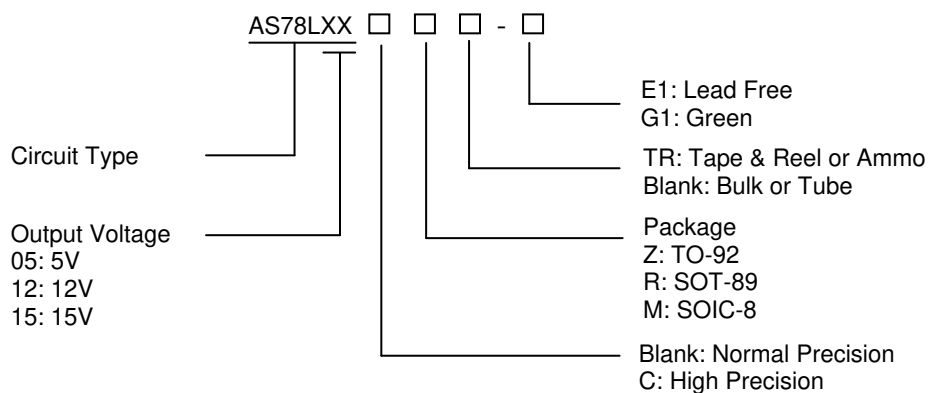
Ordering Information

Package	Temperature Range	Part Number		Marking ID		Packing Type
		Lead Free	Green	Lead Free	Green	
TO-92	-40 to 125°C	AS78L05Z-E1	AS78L05Z-G1	AS78L05Z-E1	AS78L05Z-G1	Bulk
		AS78L05ZTR-E1	AS78L05ZTR-G1	AS78L05Z-E1	AS78L05Z-G1	Ammo
		AS78L05CZTR-E1	AS78L05CZTR-G1	AS78L05Z-E1	AS78L05Z-G1	Ammo
		AS78L12Z-E1	AS78L12Z-G1	AS78L12Z-E1	AS78L12Z-G1	Bulk
		AS78L12ZTR-E1	AS78L12ZTR-G1	AS78L12Z-E1	AS78L12Z-G1	Ammo
		AS78L15Z-E1	AS78L15Z-G1	AS78L15Z-E1	AS78L15Z-G1	Bulk
		AS78L15ZTR-E1	AS78L15ZTR-G1	AS78L15Z-E1	AS78L15Z-G1	Ammo
SOT-89	-40 to 125°C	AS78L05RTR-E1	AS78L05RTR-G1	E78E	G78E	Tape & Reel
		AS78L12RTR-E1	AS78L12RTR-G1	E78F	G78F	Tape & Reel
		AS78L15RTR-E1	AS78L15RTR-G1	E78G	G78G	Tape & Reel
SOIC-8	-40 to 125°C	AS78L05M-E1	AS78L05M-G1	AS78L05M-E1	AS78L05M-G1	Tube
		AS78L05MTR-E1	AS78L05MTR-G1	AS78L05M-E1	AS78L05M-G1	Tape & Reel
		AS78L12M-E1	AS78L12M-G1	AS78L12M-E1	AS78L12M-G1	Tube
		AS78L12MTR-E1	AS78L12MTR-G1	AS78L12M-E1	AS78L12M-G1	Tape & Reel
		AS78L15M-E1	AS78L15M-G1	AS78L15M-E1	AS78L15M-G1	Tube
		AS78L15MTR-E1	AS78L15MTR-G1	AS78L15M-E1	AS78L15M-G1	Tape & Reel

BCD Semiconductor's Pb-free products, as designated with "E1" suffix in the part number, are RoHS compliant. Products with "G1" suffix are available in green packages.

Package Outline Dimensions (cont.) (All dimensions in mm(inch).)

SOT-89

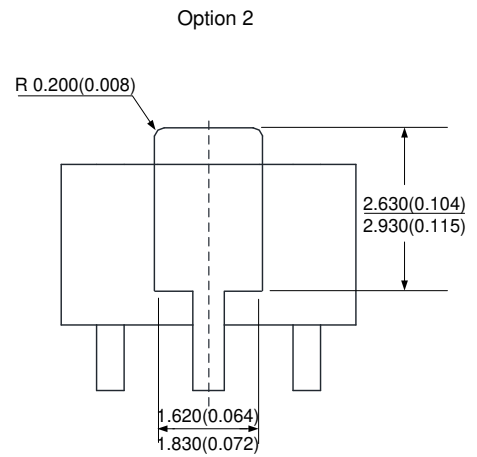
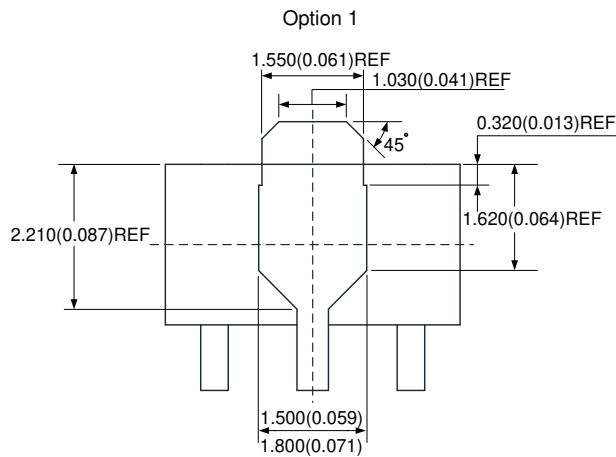
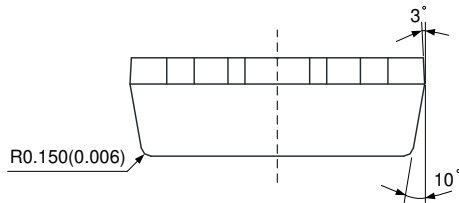
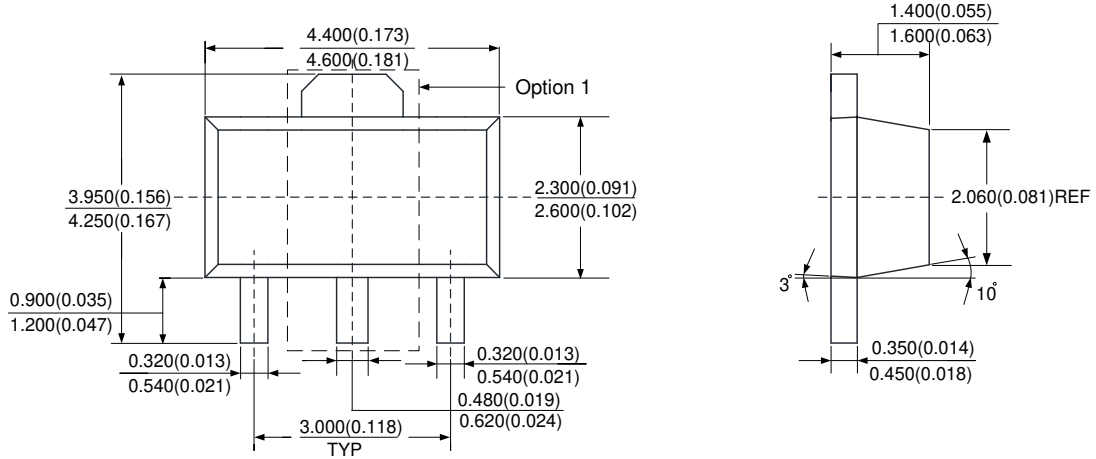

Suggested Pad Layout

SOT-89

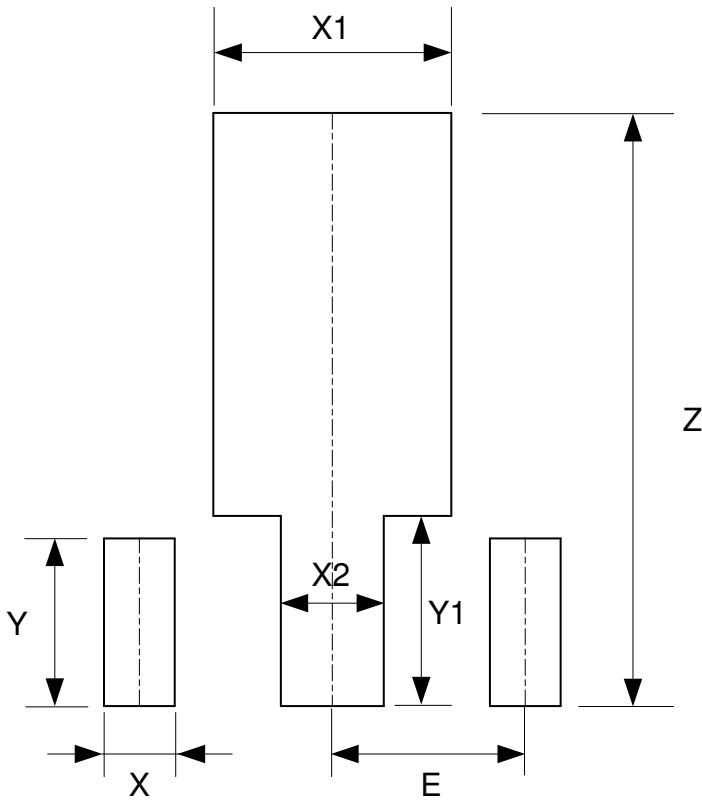

Dimensions	Z (mm)/(inch)	X (mm)/(inch)	X1 (mm)/(inch)	X2 (mm)/(inch)	Y (mm)/(inch)	Y1 (mm)/(inch)	E (mm)/(inch)
Value	4.600/0.181	0.550/0.022	1.850/0.073	0.800/0.031	1.300/0.051	1.475/0.058	1.500/0.059

Suggested Pad Layout (cont.)

SOIC-8

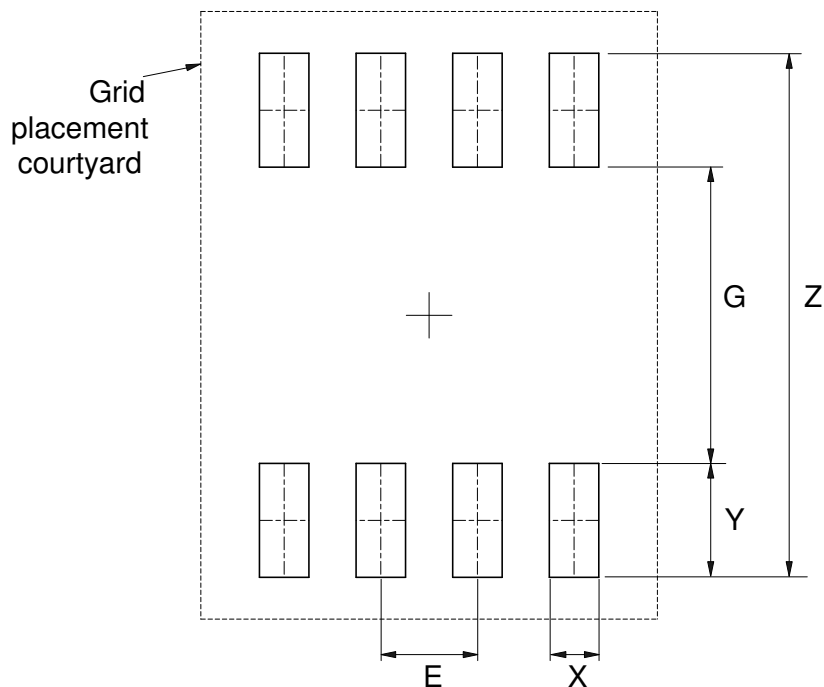

Dimensions	Z (mm)/(inch)	G (mm)/(inch)	X (mm)/(inch)	Y (mm)/(inch)	E (mm)/(inch)
Value	6.900/0.272	3.900/0.154	0.650/0.026	1.500/0.059	1.270/0.050

IMPORTANT NOTICE

1. DIODES INCORPORATED AND ITS SUBSIDIARIES (“DIODES”) MAKE NO WARRANTY OF ANY KIND, EXPRESS OR IMPLIED, WITH REGARDS TO ANY INFORMATION CONTAINED IN THIS DOCUMENT, INCLUDING, BUT NOT LIMITED TO, THE IMPLIED WARRANTIES OF MERCHANTABILITY, FITNESS FOR A PARTICULAR PURPOSE OR NON-INFRINGEMENT OF THIRD PARTY INTELLECTUAL PROPERTY RIGHTS (AND THEIR EQUIVALENTS UNDER THE LAWS OF ANY JURISDICTION).
2. The Information contained herein is for informational purpose only and is provided only to illustrate the operation of Diodes products described herein and application examples. Diodes does not assume any liability arising out of the application or use of this document or any product described herein. This document is intended for skilled and technically trained engineering customers and users who design with Diodes products. Diodes products may be used to facilitate safety-related applications; however, in all instances customers and users are responsible for (a) selecting the appropriate Diodes products for their applications, (b) evaluating the suitability of the Diodes products for their intended applications, (c) ensuring their applications, which incorporate Diodes products, comply the applicable legal and regulatory requirements as well as safety and functional-safety related standards, and (d) ensuring they design with appropriate safeguards (including testing, validation, quality control techniques, redundancy, malfunction prevention, and appropriate treatment for aging degradation) to minimize the risks associated with their applications.
3. Diodes assumes no liability for any application-related information, support, assistance or feedback that may be provided by Diodes from time to time. Any customer or user of this document or products described herein will assume all risks and liabilities associated with such use, and will hold Diodes and all companies whose products are represented herein or on Diodes’ websites, harmless against all damages and liabilities.
4. Products described herein may be covered by one or more United States, international or foreign patents and pending patent applications. Product names and markings noted herein may also be covered by one or more United States, international or foreign trademarks and trademark applications. Diodes does not convey any license under any of its intellectual property rights or the rights of any third parties (including third parties whose products and services may be described in this document or on Diodes’ website) under this document.
5. Diodes products are provided subject to Diodes’ Standard Terms and Conditions of Sale (<https://www.diodes.com/about/company/terms-and-conditions/terms-and-conditions-of-sales/>) or other applicable terms. This document does not alter or expand the applicable warranties provided by Diodes. Diodes does not warrant or accept any liability whatsoever in respect of any products purchased through unauthorized sales channel.
6. Diodes products and technology may not be used for or incorporated into any products or systems whose manufacture, use or sale is prohibited under any applicable laws and regulations. Should customers or users use Diodes products in contravention of any applicable laws or regulations, or for any unintended or unauthorized application, customers and users will (a) be solely responsible for any damages, losses or penalties arising in connection therewith or as a result thereof, and (b) indemnify and hold Diodes and its representatives and agents harmless against any and all claims, damages, expenses, and attorney fees arising out of, directly or indirectly, any claim relating to any noncompliance with the applicable laws and regulations, as well as any unintended or unauthorized application.
7. While efforts have been made to ensure the information contained in this document is accurate, complete and current, it may contain technical inaccuracies, omissions and typographical errors. Diodes does not warrant that information contained in this document is error-free and Diodes is under no obligation to update or otherwise correct this information. Notwithstanding the foregoing, Diodes reserves the right to make modifications, enhancements, improvements, corrections or other changes without further notice to this document and any product described herein. This document is written in English but may be translated into multiple languages for reference. Only the English version of this document is the final and determinative format released by Diodes.
8. Any unauthorized copying, modification, distribution, transmission, display or other use of this document (or any portion hereof) is prohibited. Diodes assumes no responsibility for any losses incurred by the customers or users or any third parties arising from any such unauthorized use.

Copyright © 2021 Diodes Incorporated

www.diodes.com