

Data Sheet	AS04504PS-X-R
------------	---------------

PUI Audio's eXtreme Series speakers are purpose-built for superior performance using Klippel-optimized motor designs. Forced-air vented voice coils combine with a high-grade neodymium motor for extreme power handling, extremely flat frequency response, and a surprising amount of bass when used with tuned-port or passive radiator assisted enclosures.

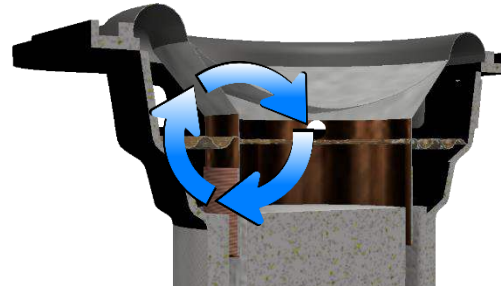

Air is forced into the magnetic loop on both sides of the voice coil for improved heat dissipation

Features:

- Poly-coated paper cone for warm natural sound and improved ruggedness
- Large voice coil diameter for high power handling
- Convenient mounting frame for easy integration
- Venting in the magnetic motor creates forced-air cooling limiting power compression
- Two-layer copper-clad aluminum wire for great transient response
- Water and dustproof to IP65
- Low Qts design for use in ultra-small enclosures without inhibiting performance

Specifications

Parameters	Values	Units
Rated Input Power	10	Watts
Max Input Power	20	Watts
Impedance	4 ± 15%	Ohms
SPL @ 1W/0.5m (Average 0.8, 1.0, 1.2, 1.5 kHz)	86 ± 3	dB
Resonant Frequency	170 ± 20%	Hz
Frequency Range (-10 dB)	90 ~ 20,000+	Hz
Frame Material	Stamped Steel	-
Magnet Material	NdFeB	-
Weight	63	Grams
Ingress Protection Rating	IP65	-
Recommended Sealed Enclosure Volume Range (Qtc ≤ 0.707)*	0.05 ~ 0.40	Liters
Recommended Vented Enclosure Volume*	0.40	Liters
Vent Size and Tuning Frequency	20mm dia. x 244mm L, 100 Hz	-

*Recommended enclosure volumes do not include volume displaced by speaker or vent

Speaker Specifications (continued)

Acceptable Soldering Methods	Hand Solder	-
Buzz, Rattle, etc.	Should not be audible with 6.32V sine wave from 90 Hz to 20 kHz	-
Environmental Compliances	RoHS 2015/863/EU, REACH 197	-
Polarity	Cone shall move forward when a positive voltage is applied to the positive terminal	-
Operating Temperature	-25 ~ +60	°C

Measurement Method (1W input power with microphone spaced at 50cm)

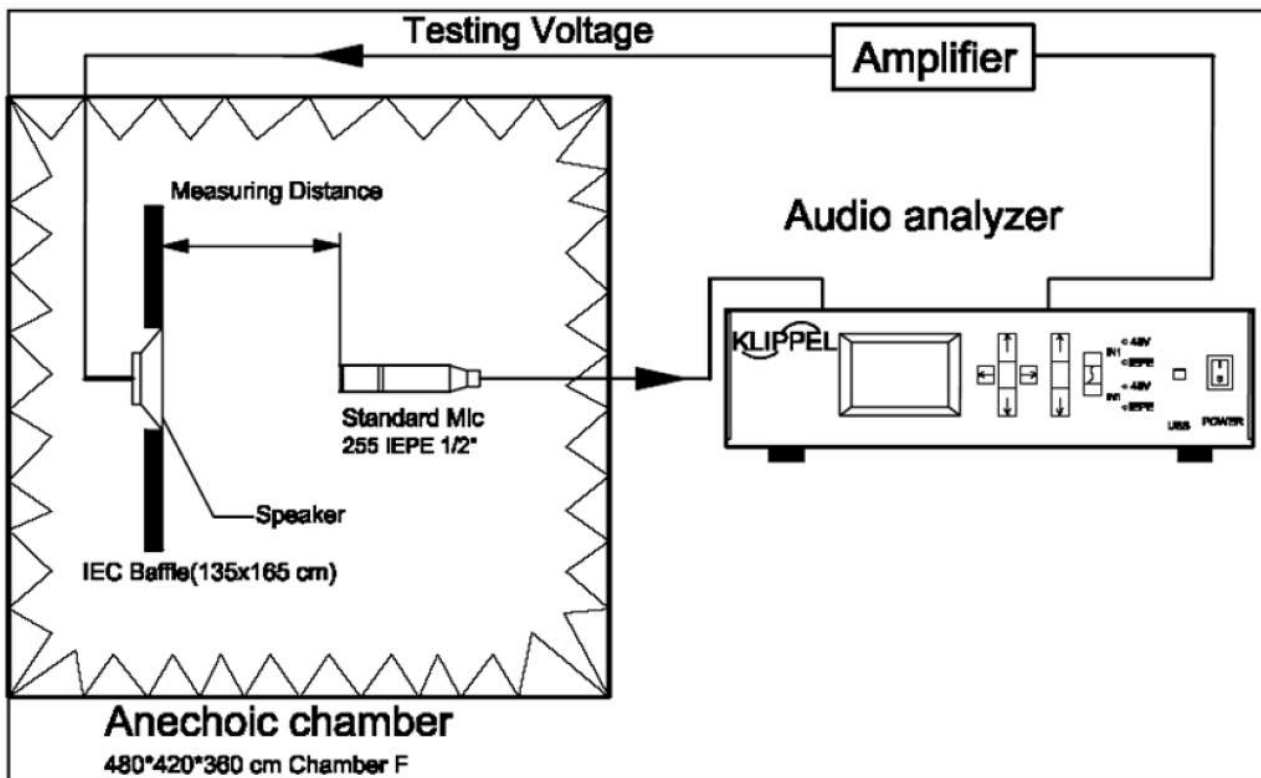

Typical Frequency Response (Tested at 1W/50cm)

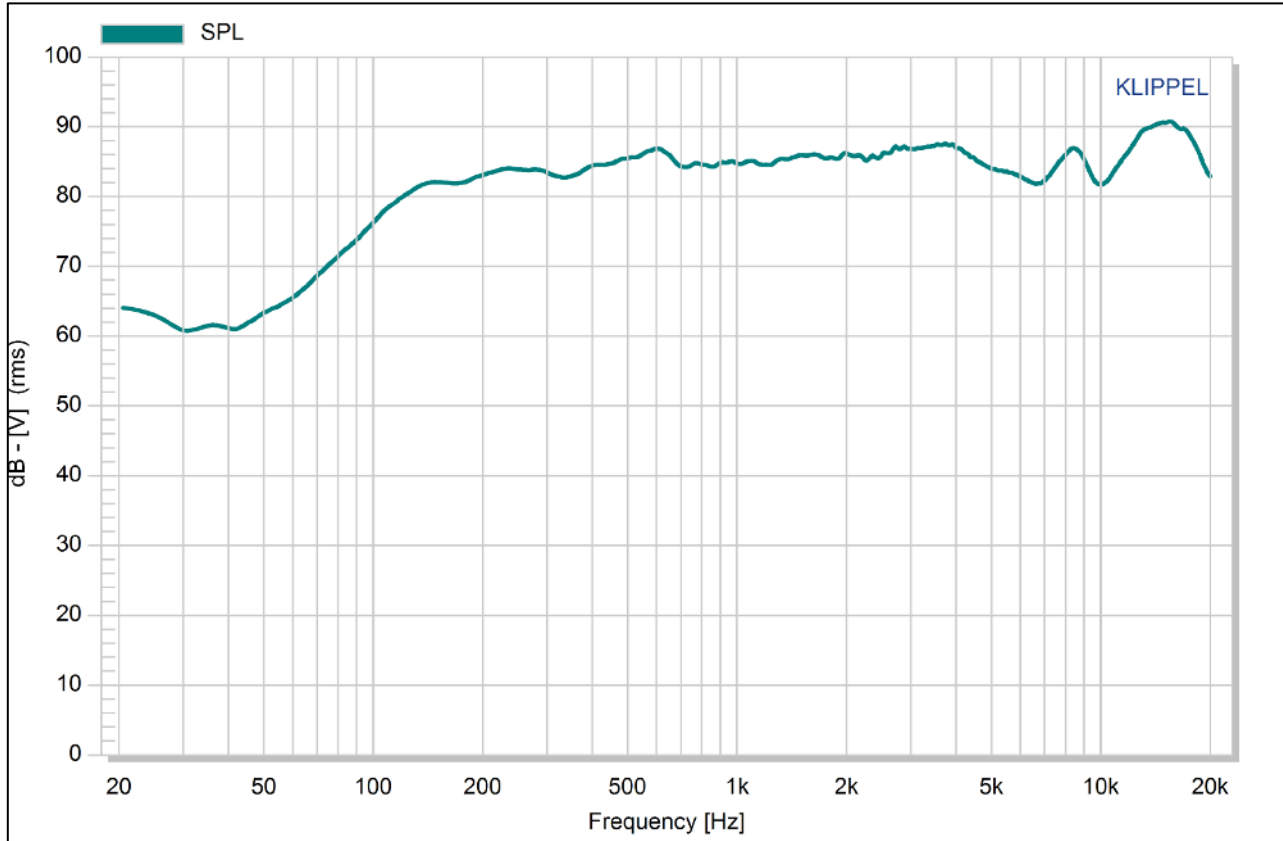

Typical Impedance Response

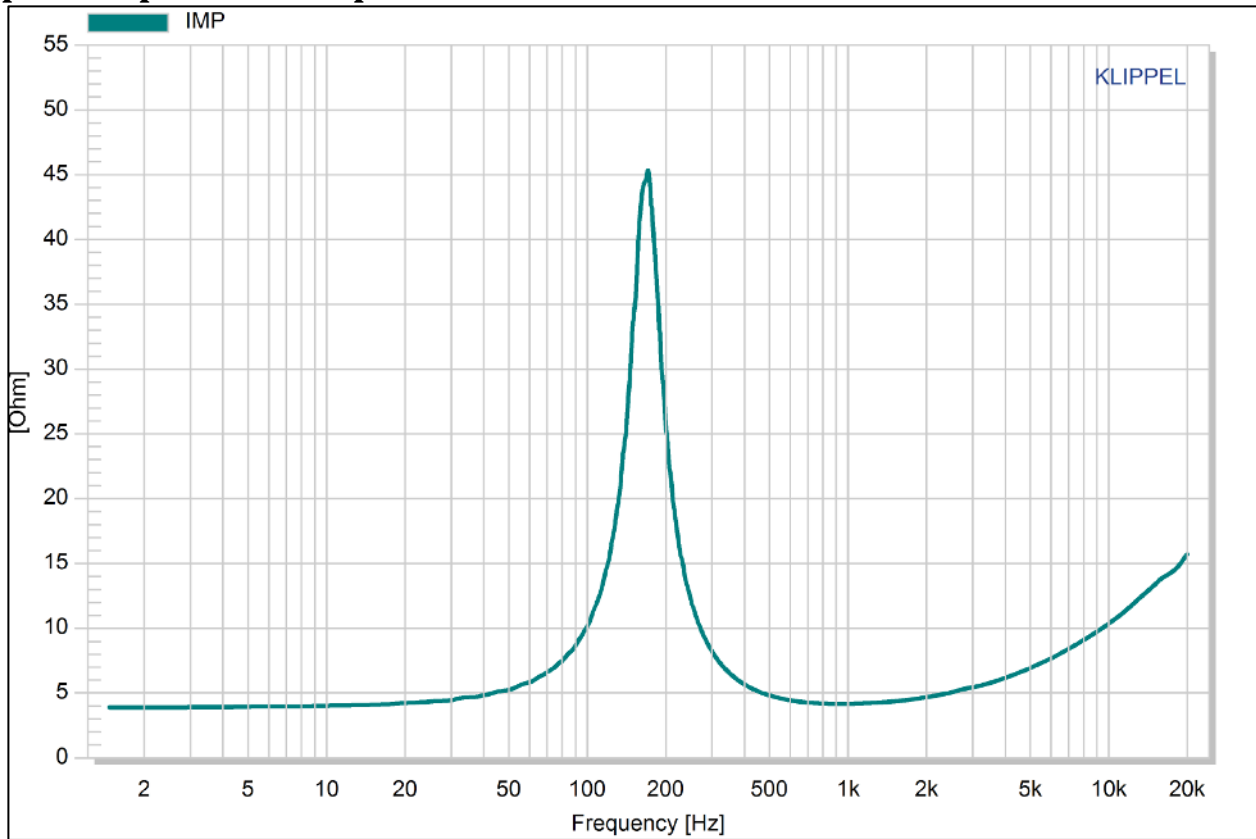

Typical Thiele-Small Parameters (based on Golden Sample, up to 20% variance is normal)

Specification	Value	Description
Re	3.7 Ohms	DC resistance
Le	0.093 mH	Inductance @ 10 kHz
Fs	166 Hz	Resonant Frequency
Mms	1.114 grams	Moving Mass
Bl	2.86 N/A	Magnet Force Factor
Qms	4.556	Mechanical Q-factor
Qes	0.528	Electrical Q-factor
Qts	0.473	Total Q-factor
Vas	0.0907 liters	Equivalent Air Volume of Suspension
Xmax	4 mm	One-Way Voice Coil Travel @ 15W Input

Klippel Tested Excursion

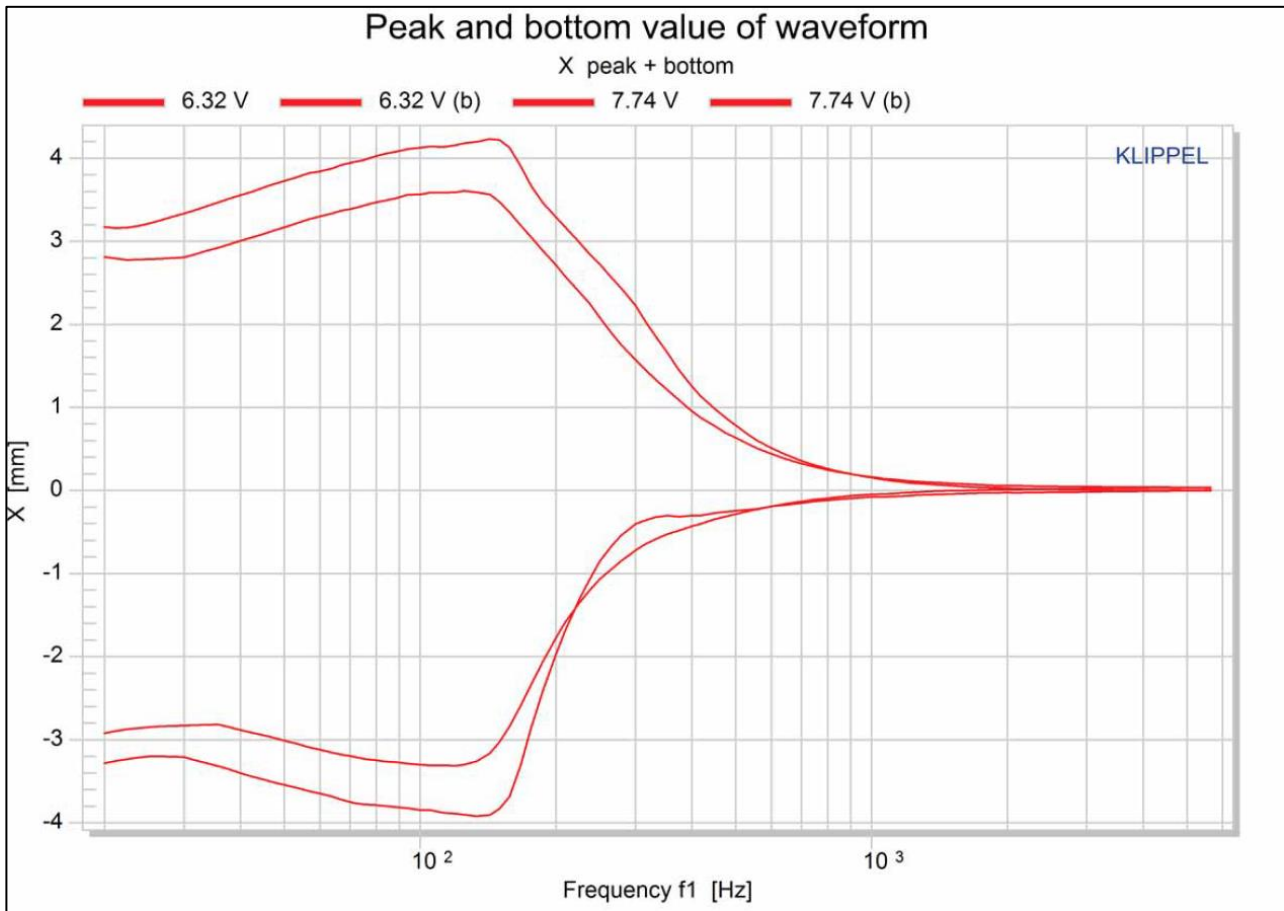

Reliability Testing

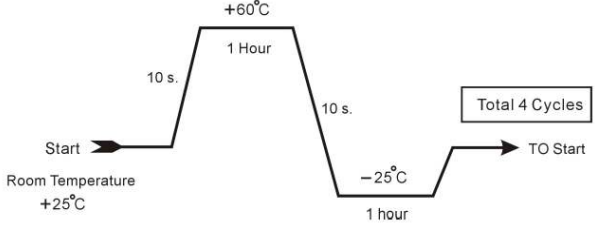
Type of Test	Test Specifications
High Temperature Test	96 hours at +60°C ± 2°C followed by three hours in normal room temperature
Low Temperature Test	96 hours at -20°C ± 3°C followed by three hours in normal room temperature
Humidity Test	96 hours at +40°C ± 2°C with relative humidity between 90% and 95% followed by 6 hours in normal room temperature
Temperature Cycle Testing	
Vibration Test	Frequency 30±15 Hz, Amplitude 1.5 mm for 3 Hours. After test, SPL shall not deviate by ±3 dB from pre-test measurement
Drop Test	75 cm free falling on concrete floor, 10 times.
Load Test	Speaker should not fail after applying 20 Hz ~ 20 kHz pink noise with HPF rated power input (RMS), 96 hours.

After each test, SPL shall not deviate by more than ±3 dB from pre-test measurement.

Dimensions (Left terminal is positive and is indicated by + on the terminal board)

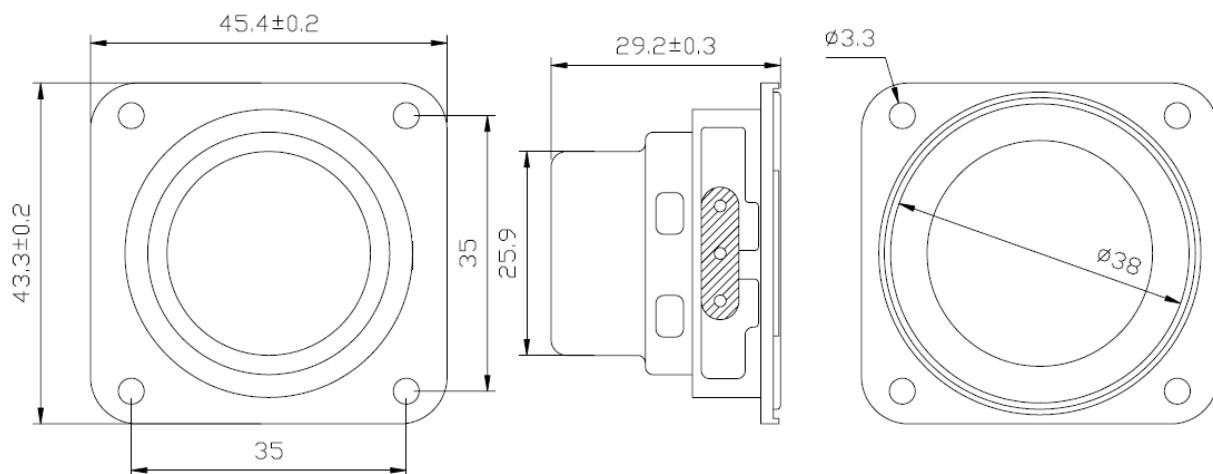

Note: Recommended speaker baffle opening is 41mm. Always test-fit prior to closing mechanical design. Please maintain at least 6mm distance between top of frame and next surface.

Specifications Revisions

Revision	Description	Date
-	Released from Engineering	6/14/19

Note:

- 1. Unless otherwise specified:
 - A. All dimensions are in millimeters.
 - B. Default tolerances are $\pm 0.5\text{mm}$ and angles are $\pm 3^\circ$.
- 2. Specifications subject to change or withdrawal without notice.