



PXIe-SMU5101 Bundle

Expandable PXI bundle based on PXIe-4139 SMU,
 ± 60 V, ± 3 A DC, ± 10 A Pulsed, 40 W DC, 100 fA

Specifications

PXIe-1083 and PXIe-4139 (40 W DC)

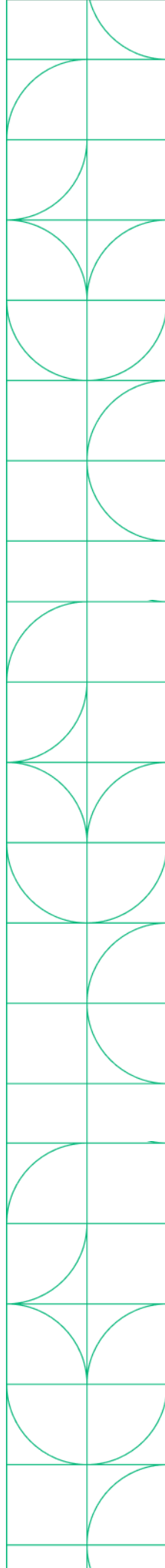

PXI SMU Bundle

In the Box

PXIe-SMU5101 Bundle Bundle P/N: 867111-01



PXIe-4139
(SMU)



PXIe-1083
(5-Slot PXIe Chassis)

Accessories:

- Thunderbolt cable
- Power cable, US

Recommended Software

Test Workflow P/N: 788509-35



Test Workflow is a bundle of select NI software featuring engineering-specific tools that help test professionals accomplish anything from their day-to-day work to overcoming their most challenging obstacles.

Test Workflow includes:

- **LabVIEW** - a graphical programming environment engineers use to develop automated research, validation, and production test systems.
- **InstrumentStudio** - an application software that provides an integrated approach to interactive PXI measurements.
- **TestStand** - a test executive software that accelerates system development and deployment for engineers in validation and production.
- And more NI Software!

Table of Contents

This document combines the PDFs of this bundle together. The page numbers in the table of contents correspond to the page number of PDF the component's documentation begins.

PXIe-1083 Specifications.....	3
PXIe-4139 Specifications.....	16



PXIe-1083

Specifications



PXIe-1083 Specifications

This document contains specifications for the PXIe-1083 chassis.

Electrical

The following section provides information about the PXIe-1083 AC input and DC output.

AC Input

Input rating	100 VAC to 240 VAC, 50 Hz/60 Hz, 6 A to 3 A
Operating voltage range ¹	90 VAC to 264 VAC
Nominal input frequency	50 Hz/60 Hz
Operating frequency range ¹	47 Hz to 63 Hz
Efficiency	78% typical
Over-current protection	Internal fuse in line
Main power disconnect	The AC power cable provides main power disconnect. Do not position the equipment so that it is difficult to disconnect the power cord. The front-panel power switch causes the internal chassis power supply to provide DC power to the PXI Express backplane.



Caution Disconnect power cord to completely remove power.

DC Output

DC output characteristics of the PXIe-1083.

Voltage Rail	Maximum Current	Load Regulation	Maximum Ripple and Noise (20 MHz BW)
+5V_AUX	1.0 A	±5%	50 mVpp
+12 V	30.1 A	±5%	120 mVpp
+5 V	25.1 A	±5%	50 mVpp
+3.3 V	30.7 A	±5%	50 mVpp
-12 V	0.75 A	±5%	120 mVpp

Maximum total available power for the PXIe-1083 is 293 W.

The maximum combined power available on +3.3 V and +5 V is 180 W.

The maximum power available for each Thunderbolt port is 15 W (5 V/3 A).

Table 1. Backplane Slot Current Capacity

Slot	+5 V	V (I/O)	+3.3 V	+12 V	-12 V	5 V _{AUX}
Hybrid Peripheral Slot with PXI-5 Peripheral	-	-	3 A	6 A	-	1 A
Hybrid Peripheral Slot with PXI-1 Peripheral	6 A	5 A	6 A	1 A	1 A	-



Note PCI V(I/O) pins in Hybrid Peripheral Slots are connected to +5 V.



Note The maximum power dissipated in a peripheral slot should not exceed 58 W. Refer to the **Operating Environment** section for ambient temperature considerations at 58 W.

Over-current protection	All outputs are protected from short circuit and overload, they recover and return to regulation when the overload is removed and the power is cycled.
Over-voltage protection	+3.3 V clamped at 3.7 V to 4.3 V, +5 V clamped at 5.7 V to 6.5 V, +12 V clamped at 13.4 V to 15.6 V

Chassis Cooling

Module cooling	Forced air circulation (positive pressurization) through one 150 CFM fan
Module slot airflow direction	Bottom of module to top of module
Module intake	Bottom of chassis
Module exhaust	Top, right side of chassis
Slot cooling capacity	58 W; slot 6 supports 58 W cooling with high fan mode
Power supply cooling	Forced air circulation through integrated fans
Power supply intake	Front and left side chassis
Power supply exhaust	Rear of chassis
Minimum chassis cooling clearances	
Above	44.45 mm (1.75 in.)
Rear	44.45 mm (1.75 in.)
Sides	44.45 mm (1.75 in.)
Below	
Rack	44.45 mm (1.75 in.)
Desktop	25.4 mm (1.00 in.)

Environmental

Maximum altitude	2,000 m (6,560 ft.), 800 mbar (at 25 °C ambient, high fan mode)
Pollution Degree	2

Indoor use only.

Operating Environment

<p>Ambient temperature range</p> <p>When all peripheral modules require ≤ 38 W cooling capacity per slot</p> <p>0 °C to 50 °C (IEC 60068-2-1 and IEC 60068-2-2.)² Meets MIL-PRF-28800F Class 3 low temperature limit and high temperature limit.</p> <p>When any peripheral module requires > 38 W cooling capacity per slot</p> <p>0 °C to 40 °C (IEC 60068-2-1 and IEC 60068-2-2.)² Meets MIL-PRF-28800F Class 3 low temperature limit and MIL-PRF-28800F Class 4 high temperature limit.</p>	
Relative humidity range	20% to 80%, noncondensing

Storage Environment

Ambient temperature range	-40 °C to 71 °C (IEC-60068-2-1 and IEC-60068-2-2.) ^[3] Meets MIL-PRF-28800F Class 3 limits.
Relative humidity range	10% to 95%, noncondensing

Shock and Vibration

Operational shock	30 g peak, half-sine, 11 ms pulse (IEC-60068-2-27.) ³ Meets MIL-PRF-28800F Class 2 limits.
Operational random vibration	5 to 500 Hz, 0.3 g _{rms}
Non-operating vibration	5 to 500 Hz, 2.4 g _{rms} (IEC 60068-2-64.) ³ Non-operating test profile exceeds the requirements of MIL-PRF-28800F, Class 3.

Acoustic Emissions

Sound Pressure Level (at Operator Position)

(Tested in accordance with ISO 7779. Meets MIL-PRF-28800F requirements.)

38 W Profile

Auto fan (up to 30 °C ambient)	33.7 dBA
High fan	50.8 dBA

58 W Profile

Auto fan (up to 30 °C ambient)	54.7 dBA
High fan	55.3 dBA

Sound Power Level

38 W Profile

Auto fan (up to 30 °C ambient)	44.9 dBA
High fan	60.3 dBA

58 W Profile

Auto fan (up to 30 °C ambient)	63.4 dBA
High fan	64.2 dBA



Note The protection provided by the PXIe-1083 can be impaired if it is used in a manner not described in this document.

Safety Compliance Standards

This product is designed to meet the requirements of the following electrical equipment safety standards for measurement, control, and laboratory use:

- IEC 61010-1, EN 61010-1
- UL 61010-1, CSA C22.2 No. 61010-1



Note For safety certifications, refer to the product label or the [Product Certifications and Declarations](#) section.

EMC Guidelines

This product was tested and complies with the regulatory requirements and limits for electromagnetic compatibility (EMC) stated in the product specifications. These requirements and limits provide reasonable protection against harmful interference when the product is operated in the intended operational electromagnetic environment.

This product is intended for use in industrial locations. However, harmful interference may occur in some installations, when the product is connected to a peripheral device or test object, or if the product is used in residential areas. To minimize interference with radio and television reception and prevent unacceptable performance degradation, install and use this product in strict accordance with the instructions in the product documentation.

Furthermore, any changes or modifications to the product not expressly approved by NI could void your authority to operate it under your local regulatory rules.

EMC Notices

Refer to the following notices for cables, accessories, and prevention measures necessary to ensure the specified EMC performance.



Notice

For EMC declarations and certifications, and additional information, refer to the [Product Certifications and Declarations](#) section.



Notice Changes or modifications to the product not expressly approved by NI could void your authority to operate the product under your local regulatory rules.



Notice Operate this product only with shielded cables and accessories.

Electromagnetic Compatibility Standards

This product meets the requirements of the following EMC standards for electrical equipment for measurement, control, and laboratory use:

- EN 61326-1 (IEC 61326-1): Class A emissions; Basic immunity
- EN 55011 (CISPR 11): Group 1, Class A emissions

- AS/NZS CISPR 11: Group 1, Class A emissions



Note Group 1 equipment (per CISPR 11) is any industrial, scientific, or medical equipment that does not intentionally generate radio frequency energy for the treatment of material or inspection/analysis purposes.



Note In Europe, Canada, Australia, and New Zealand (per CISPR 11) Class A equipment is intended for use in nonresidential locations.

CE Compliance

This product meets the essential requirements of applicable European Directives, as follows:

- 2014/35/EU; Low-Voltage Directive (safety)
- 2014/30/EU; Electromagnetic Compatibility Directive (EMC)
- 2011/65/EU; Restriction of Hazardous Substances (RoHS)

Product Certifications and Declarations

Refer to the product Declaration of Conformity (DoC) for additional regulatory compliance information. To obtain product certifications and the DoC for NI products, visit ni.com/product-certifications, search by model number, and click the appropriate link.

Environmental Management

NI is committed to designing and manufacturing products in an environmentally responsible manner. NI recognizes that eliminating certain hazardous substances from our products is beneficial to the environment and to NI customers.

For additional environmental information, refer to the **Engineering a Healthy Planet** web page at ni.com/environment. This page contains the environmental

regulations and directives with which NI complies, as well as other environmental information not included in this document.

EU and UK Customers

-  Waste Electrical and Electronic Equipment (WEEE)—At the end of the product life cycle, all NI products must be disposed of according to local laws and regulations. For more information about how to recycle NI products in your region, visit ni.com/environment/weee.

电子信息产品污染控制管理办法 (中国 RoHS)

-  中国 RoHS— NI 符合中国电子信息产品中限制使用某些有害物质指令(RoHS)。关于 NI 中国 RoHS 合规性信息，请登录 ni.com/environment/rohs_china。(For information about China RoHS compliance, go to ni.com/environment/rohs_china.)

Backplane

Size	3U-sized; 5 peripheral slots. Compliant with IEEE 1101.10 mechanical packaging. PXI Express Specification compliant. Accepts both PXI Express and CompactPCI (PICMG 2.0 R 3.0) 3U modules.
Backplane bare-board material	UL 94 V-0 Recognized
Backplane connectors	Conforms to IEC 917 and IEC 1076-4-101, UL 94 V-0 rated

System Synchronization Clocks

10 MHz System Reference Clock: PXI_CLK10

Maximum slot-to-slot skew	250 ps
Accuracy	± 25 ppm max (guaranteed over the operating temperature range)
Maximum jitter	5 ps RMS phase-jitter (10 Hz–1 MHz range)
Duty-factor	45% to 55%
Unloaded signal swing	3.3 V \pm 0.3 V



Note For other specifications, refer to the **PXI-1 Hardware Specification**.

100 MHz System Reference Clock: PXIe_CLK100 and PXIe_SYNC100

Maximum slot-to-slot skew	100 ps
Accuracy	± 25 ppm max (guaranteed over the operating temperature range)
Maximum jitter	3 ps RMS phase-jitter (10 Hz to 12 kHz range), 2 ps RMS phase-jitter (12 kHz to 20 MHz range)
Duty-factor for PXIe_CLK100	45% to 55%
Absolute differential voltage (When terminated with a 50 Ω load to 1.30 V or Thévenin equivalent)	400 mV to 1000 mV



Note For other specifications, refer to the **PXI-5 PXI Express Hardware Specification**.

Mechanical

Standard chassis dimensions	
Height	177.1 mm (6.97 in.)
Width	257.1 mm (10.12 in.)
Depth	214.2 mm (8.43 in.)
Weight	6.7 kg (14.8 lb)
Chassis materials	Extruded Aluminum (6063-T5, 6060-T6), Cold Rolled Steel/Stainless Steel, Santoprene, Urethane Foam, PC-ABS, Nylon, Polyethylene
Finish	Conductive Clear Iridite on Aluminum, Electroplated Nickel on Cold Rolled Steel, Electroplated Zinc on Cold Rolled Steel

The following figures show the PXIe-1083 chassis dimensions. The holes shown are for installing the optional rack mount kits.

Figure 1. PXIe-1083 Chassis Dimensions (Front)

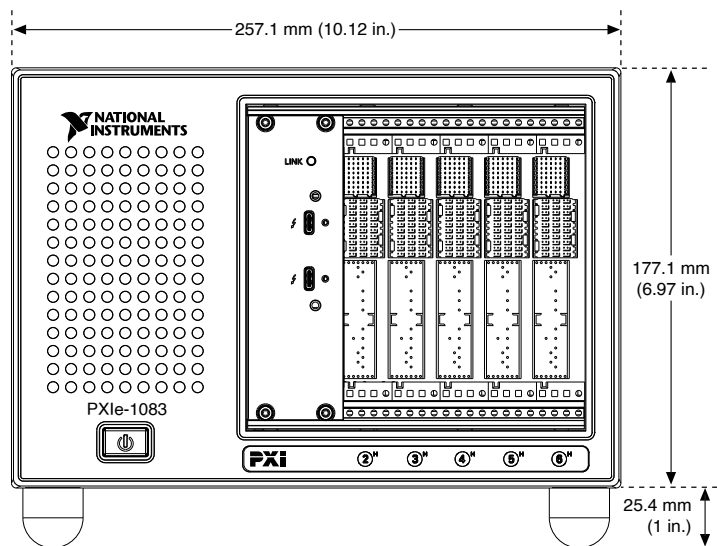

Figure 2. PXIe-1083 Chassis Dimensions (Side)

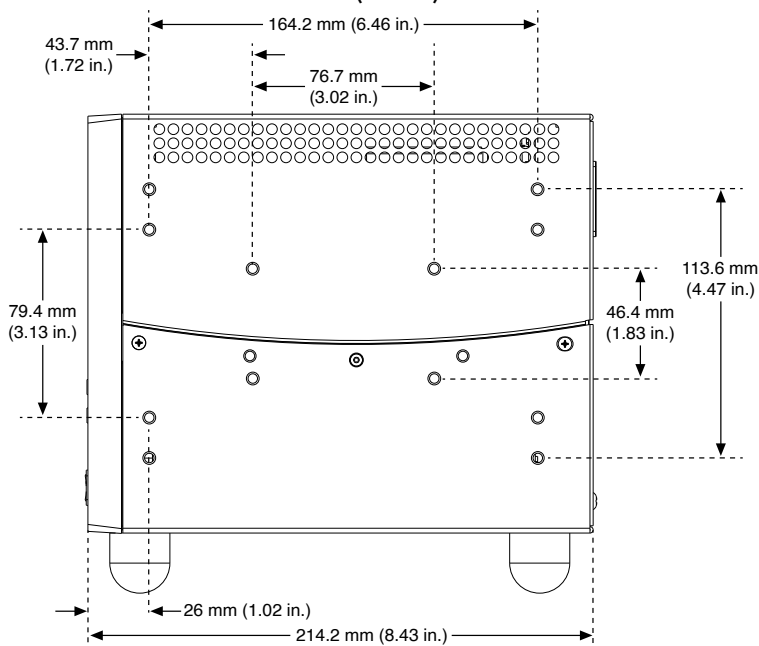
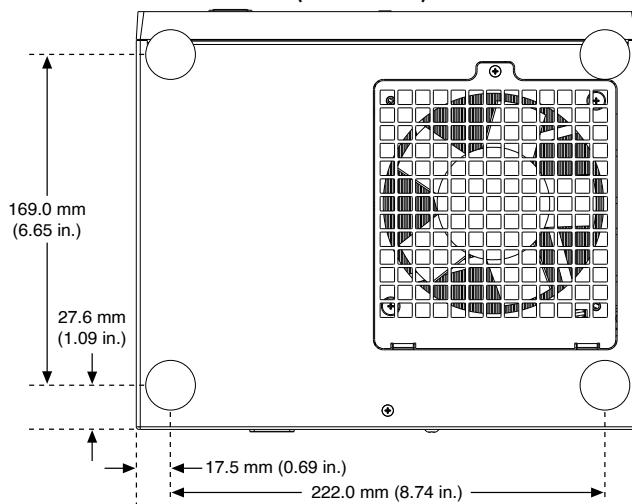

Figure 3. PXIe-1083 Chassis Dimensions (Bottom)



¹ The operating range is guaranteed by design.

² This product meets the requirements of the environmental standards for electrical equipment for measurement, control, and laboratory use.

³ This product meets the requirements of the environmental standards for electrical equipment for measurement, control, and laboratory use.

PXIe-4139

Specifications



PXIe-4139 Specifications

These specifications apply to the PXIe-4139.



Note In this document, the PXIe-4139 (40W) and PXIe-4139 (20W) are referred to inclusively as the PXIe-4139. The information in this document applies to all versions of the PXIe-4139 unless otherwise specified. To determine which version of the module you have, locate the device name in one of the following places:

- In MAX—The PXIe-4139 (40W) shows **NI PXIe-4139 (40W)**, and the PXIe-4139 (20W) shows as **NI PXIe-4139**.
- Device front panel—The PXIe-4139 (40W) shows **PXIe-4139 40W System SMU**, and the PXIe-4139 (20W) shows **NI PXIe-4139 Precision System SMU** on the front panel.

Definitions

Warranted specifications describe the performance of a model under stated operating conditions and are covered by the model warranty.

Characteristics describe values that are relevant to the use of the model under stated operating conditions but are not covered by the model warranty.

- **Typical** specifications describe the performance met by a majority of models.
- **Nominal** specifications describe an attribute that is based on design, conformance testing, or supplemental testing.
- **Measured** specifications describe the measured performance of a representative model.

Specifications are **Warranted** unless otherwise noted.

Conditions

Specifications are valid under the following conditions unless otherwise noted.

- Ambient temperature^[1] of $23\text{ °C} \pm 5\text{ °C}$
- Chassis with slot cooling capacity $\geq 38\text{ W}$ ^[2]
 - For chassis with slot cooling capacity = 38 W, fan speed set to HIGH
- Calibration interval of 1 year
- 30 minutes warm-up time
- Self-calibration performed within the last 24 hours
- NI-DCPower Aperture Time is set to 2 power-line cycles (PLC)

Cleaning Statement



Notice Clean the hardware with a soft, nonmetallic brush. Make sure that the hardware is completely dry and free from contaminants before returning it to service.

Device Capabilities

The following table and figures illustrate the voltage and the current source and sink ranges of the PXIe-4139.

Table 1. Current Source and Sink Ranges

DC voltage ranges	DC current source and sink ranges
<ul style="list-style-type: none"> ▪ 600 mV ▪ 6 V ▪ 60 V^[3] 	<ul style="list-style-type: none"> ▪ 1 μA ▪ 10 μA ▪ 100 μA ▪ 1 mA ▪ 10 mA ▪ 100 mA

DC voltage ranges	DC current source and sink ranges
	<ul style="list-style-type: none"> ■ 1 A ■ 3 A ■ 10 A, pulse only

Figure 1. Quadrant Diagram for PXIe-4139 (40W)

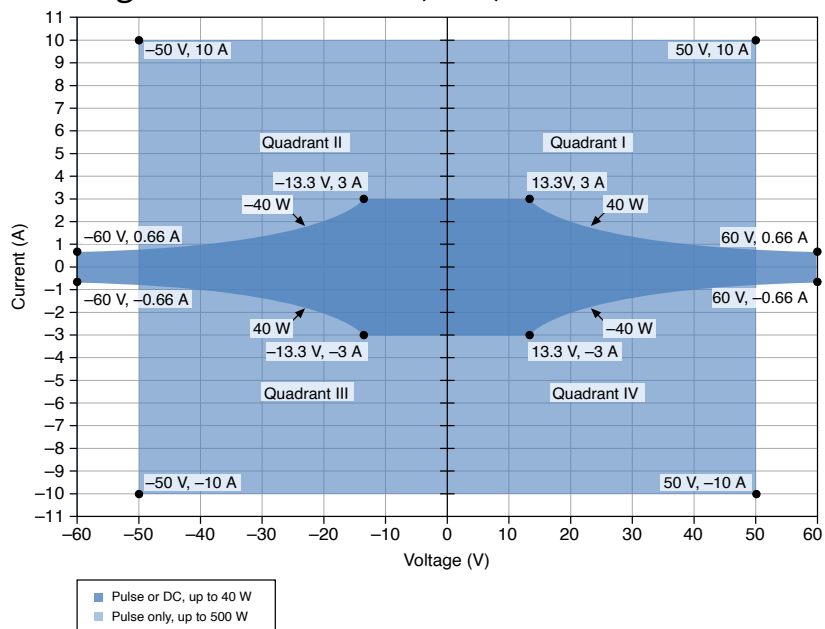

For additional information related to the Pulse Voltage or Pulse Current settings of the Output Function, for the PXIe-4139 (40W), including pulse on time and duty cycle limits for a particular operating point, refer to [Pulsed Operation](#).

For supplementary examples, refer to [Examples of Determining Extended Range Pulse Parameters and Optimizing Slew Rate using NI SourceAdapt](#).

Figure 2. Quadrant Diagram for PXIe-4139 (20W)

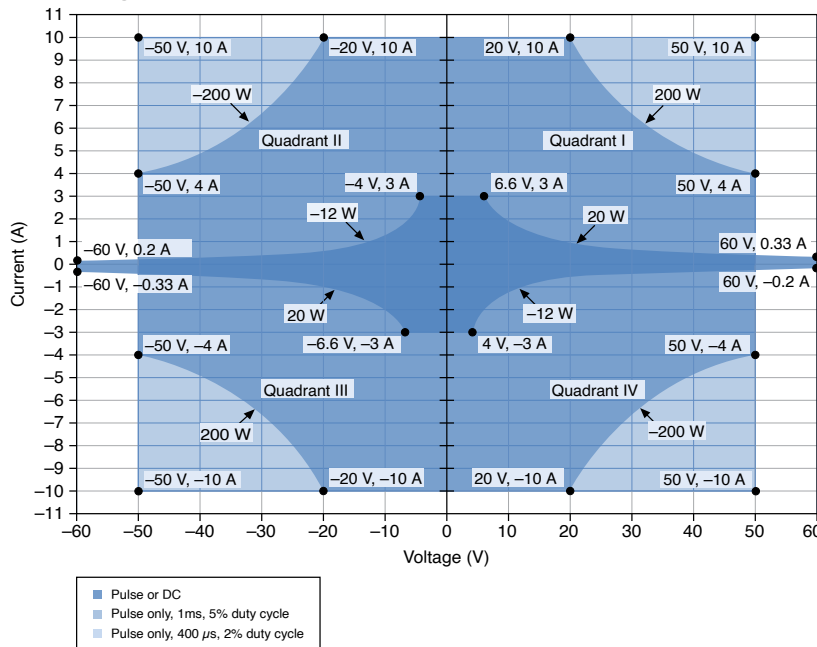

DC sourcing power and sinking power are limited to the values in the following table, regardless of output voltage.^[4]

Table 2. DC Sourcing & Sinking Power

Model Variant	Chassis Type	DC Sourcing Power	DC Sinking Power
PXIe-4139 (40W)	≥58 W Slot Cooling Capacity	40 W	40 W
	<58 W Slot Cooling Capacity	20 W	12 W
PXIe-4139 (20W)	≥58 W Slot Cooling Capacity	20 W	12 W
	<58 W Slot Cooling Capacity	20 W	12 W



Caution Limit DC power sinking to 12 W where applicable as indicated in the above table. For 38W cooling slots,

- Additional derating applies to sinking power when operating at an ambient temperature of >45 °C.
- If the PXI Express chassis has multiple fan speed settings, set the fans to the highest setting.

Related reference

- [Sinking Power vs. Ambient Temperature Derating](#)
- [Extended Range Pulsing for PXIe-4139 \(40W\)\(10\)](#)
- [Extended Range Pulsing for PXIe-4139 \(20W\)\(15\)](#)

Voltage

Table 3. Voltage Programming and Measurement Accuracy/Resolution

Range	Resolution (noise limited)	Noise (0.1 Hz to 10 Hz, peak to peak), Typical	Accuracy (23 °C ± 5 °C) ± (% of voltage + offset) [5], [6]		Tempco ± (% of voltage + offset)/°C, 0 °C to 55 °C
			T _{cal} ± 5 °C	T _{cal} ± 1 °C	
600 mV	100 nV	2 μV	0.02% + 50 μV	0.016% + 30 μV	0.0005% + 1 μV
6 V	1 μV	6 μV	0.02% + 300 μV	0.016% + 90 μV	
60 V	10 μV	60 μV	0.02% + 3 mV	0.016% + 900 μV	

Related reference

- [Load Regulation](#)
- [Remote Sense](#)
- [Noise](#)

Current

Table 4. Current Programming and Measurement Accuracy/Resolution

Range	Resolution (noise limited)	Noise (0.1 Hz to 10 Hz, peak to peak), Typical	Accuracy (23 °C ± 5 °C) ± (% of current + offset) [7]		Tempco ± (% of current + offset)/°C, 0 °C to 55 °C
			T _{cal} ± 5 °C	T _{cal} ± 1 °C	
1 μA	100 fA	4 pA	0.03% + 100 pA	0.022% + 40 pA	0.0006% + 4 pA
10 μA	1 pA	30 pA	0.03% + 700 pA	0.022% + 300 pA	0.0006% + 22 pA
100 μA	10 pA	200 pA	0.03% + 6 nA	0.022% + 2 nA	0.0006% + 200 pA
1 mA	100 pA	2 nA	0.03% + 60 nA	0.022% + 20 nA	0.0006% + 2 nA
10 mA	1 nA	20 nA	0.03% + 600 nA	0.022% + 200 nA	0.0006% + 20 nA

Range	Resolution (noise limited)	Noise (0.1 Hz to 10 Hz, peak to peak), Typical	Accuracy (23 °C ± 5 °C) ± (% of current + offset) [7]		Tempco ± (% of current + offset)/°C, 0 °C to 55 °C
			T _{cal} ± 5 °C	T _{cal} ± 1 °C	
100 mA	10 nA	200 nA	0.03% + 6 µA	0.022% + 2 µA	0.0006% + 200 nA
1 A	100 nA	2 µA	0.03% + 60 µA	0.027% + 20 µA	0.0006% + 2 µA
3 A	1 µA	20 µA	0.083% + 900 µA	0.083% + 600 µA	0.002% + 20 µA
10 A, pulsing only, typical					

Noise

Wideband source noise	<20 mV peak-to-peak in 60 V range, device configured for normal transient response, 10 Hz to 20 MHz, typical
-----------------------	--

The following figures illustrate measurement noise as a function of measurement aperture for the PXIe-4139.

Figure 1. Voltage Measurement Noise vs. Measurement Aperture, Nominal

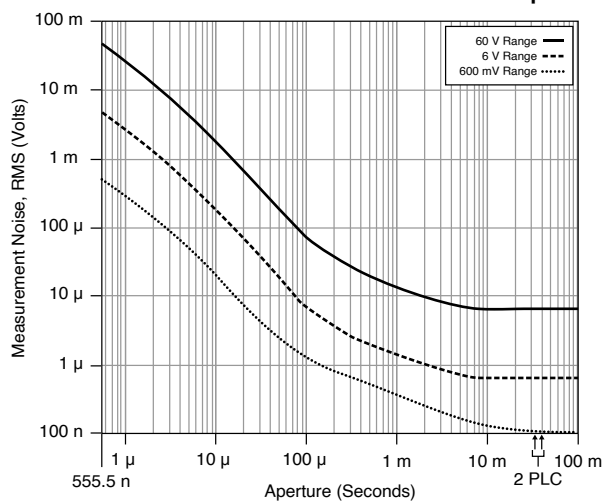



Note When the aperture time is set to 2 power-line cycles (PLCs), measurement noise differs slightly depending on whether the Power Line Frequency is set to 50 Hz or 60 Hz.

Figure 1. Current Measurement Noise vs. Measurement Aperture, Nominal

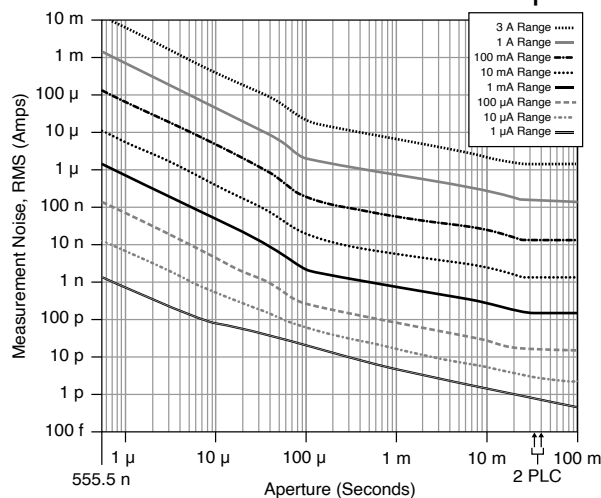

Note When the aperture time is set to 2 power-line cycles (PLCs), measurement noise differs slightly depending on whether the Power Line Frequency is set to 50 Hz or 60 Hz.

Sinking Power vs. Ambient Temperature Derating

The following figure illustrates sinking power derating as a function of ambient temperature. This applies to the PXIe-4139 (20W) when used with any chassis and only applies to the PXIe-4139 (40W) when used with a chassis with slot cooling capacity <math>< 58\text{ W}</math>.

Figure 1. Sinking Power vs. Ambient Temperature Derating

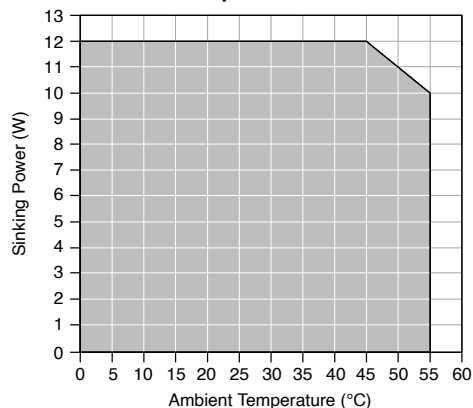

Note When using the PXIe-4139 (40W) with a chassis with slot cooling capacity ≥ 58 W, ambient temperature derating does not apply.

Output Resistance Programming Accuracy

Table 5. Output Resistance Programming Accuracy

Current Level/ Limit Range	Programmable Resistance Range, Voltage Mode	Programmable Resistance Range, Current Mode	Accuracy \pm (% of resistance setting), $T_{cal} \pm 5^\circ\text{C}$ [8]
1 μA	0 to ± 5 M Ω	± 5 M Ω to \pm infinity	0.03%
10 μA	0 to ± 500 k Ω	± 500 k Ω to \pm infinity	
100 μA	0 to ± 50 k Ω	± 50 k Ω to \pm infinity	
1 mA	0 to ± 5 k Ω	± 5 k Ω to \pm infinity	
10 mA	0 to ± 500 Ω	± 500 Ω to \pm infinity	
100 mA	0 to ± 50 Ω	± 50 Ω to \pm infinity	
1 A	0 to ± 5 Ω	± 5 Ω to \pm infinity	
3 A	0 to ± 500 m Ω	± 500 m Ω to \pm infinity	
10 A, pulsing only			

Pulsed Operation

Dynamic load, minimum pulse cycle time ^[9]	25 μ s/W
---	--------------

The following figure visually explains the terms used in the extended range pulsing sections.

Figure 6. Definition of Pulsing Terminology

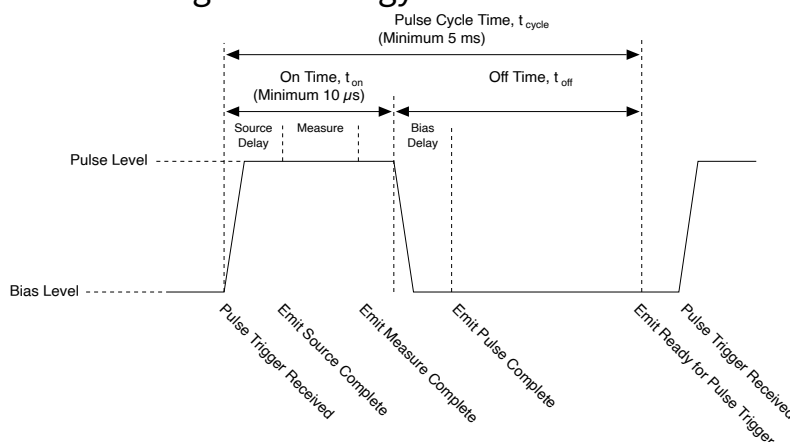

Extended Range Pulsing for PXIe-4139 (40W)^[10]

The following figures illustrate the maximum pulse on time and duty cycle for the PXIe-4139 (40W) in a ≥ 58 W cooling slot, for a desired pulse voltage and pulse current given zero bias voltage and current. The shaded areas allow for a quick approximation of output limitations and limiting parameters. Actual limits are described by equations in [Table 1](#).

Figure 7. Pulse On-time vs Pulse Current and Pulse Voltage

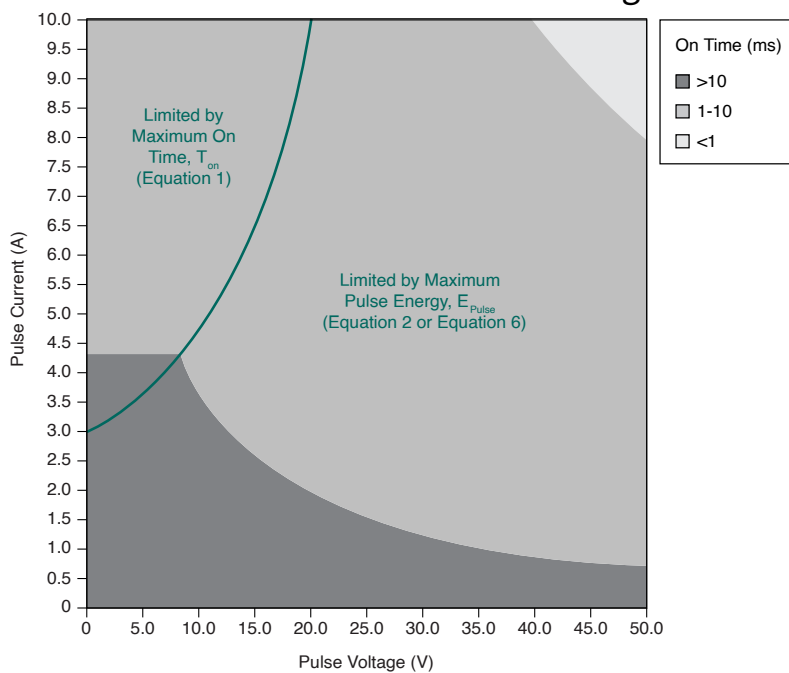

Note Equations to solve for maximum pulse on time, t_{onMax} , are shown in [Table 1](#). Additionally, Equation 6 solves for pulse on time, t_{on} , in terms of maximum pulse energy in [Example 1: Determining Extended Range Pulse On Time and Duty Cycle Parameters for the PXIe-4139 \(40W\)](#).

Figure 8. Duty Cycle vs Pulse Current and Pulse Voltage

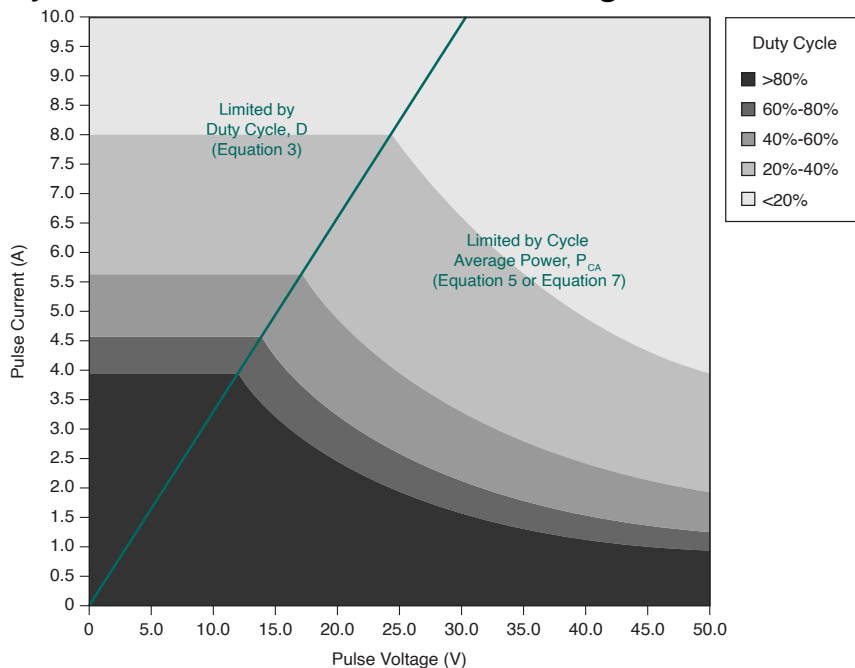

Note Equations to solve for maximum duty cycle, D_{Max} , are shown in [Table 1](#). Additionally, Equation 7 solves for pulse off time, t_{off} , in terms of maximum pulse energy in [Example 1: Determining Extended Range Pulse On Time and Duty Cycle Parameters for the PXIe-4139 \(40W\)](#).

Bias level limits

Maximum voltage, V_{bias}	60 V
Maximum current, I_{bias}	3 A

Table 6. PXIe-4139 (40W) Pulse Level Limits

Specification	Value	Equation
Maximum voltage, $V_{pulseMax}$	50 V	—
Maximum current, $I_{pulseMax}$	10 A	—
Maximum on time, $t_{onMax}^{[11]}$	If $I_{pulse} > 3 A$	Calculate using the equation or refer to Figure 1 to $t_{onMax} = 2 ms * \frac{7 A}{ I_{pulse} - 3A}$, where t_{onMax} is $\leq 167 s$

Specification		Value	Equation
		estimate the value.	(Equation 1)
	If $I_{pulse} \leq 3 \text{ A}$	$t_{onMax} = 167 \text{ s}$	—
Maximum pulse energy, $E_{pulseMax}$ ^[12]		0.4 J	$E_{pulse} = V_{pulse} * I_{pulse} * t_{on} $, where $E_{pulse} < E_{pulseMax}$ (Equation 2)
Maximum duty cycle, D_{Max} ^[13]		Calculate using the equation or refer to Figure 2 to estimate the value.	$D_{Max} = \frac{(3.68 \text{ A})^2 - I_{bias} ^2}{ I_{pulse} ^2 - I_{bias} ^2} * 100\%$ (Equation 3)
Minimum pulse cycle time, $t_{cycleMin}$		5 ms	$t_{cycle} = t_{on} + t_{off}$, where $t_{cycle} > t_{cycleMin}$ (Equation 4)
Maximum cycle average power, P_{CAMax} ^[14]	≥58 W Slot Cooling Capacity Chassis	40 W	$P_{CA} = \frac{ V_{pulse} * I_{pulse} * t_{on} + V_{bias} * I_{bias} * t_{off} }{t_{on} + t_{off}}$, where $P_{CA} < P_{CAMax}$ (Equation 5)
	<58 W Slot Cooling Capacity Chassis	10 W	



Note Software will not allow settings that violate these limiting equations and will generate an error.

Extended Range Pulsing for PXIe-4139 (20W)^[15]

Bias level limits	
Maximum voltage	60 V
Maximum current	3 A
Pulse level limits	
Maximum voltage	50 V
Maximum current	10 A
Maximum on time ^[16]	1 ms
Minimum pulse cycle time	5 ms
Energy	0.2 J
Maximum cycle average power	10 W
Maximum duty cycle	5%

Transient Response and Settling Time

Transient response	<70 μ s to recover within 0.1% of voltage range after a load current change from 10% to 90% of range, device configured for fast transient response, typical
Maximum slew rate ^{[17], [18]}	0.7 A/ μ s
Settling time^[19]	

Voltage mode, 50 V step, unloaded ^[20]	<200 μ s, typical
Voltage mode, 5 V step or smaller, unloaded ^[21]	<70 μ s, typical
Current mode, full-scale step, 10 A to 100 μ A ranges ^[22]	<50 μ s, typical
Current mode, full-scale step, 10 μ A range ^[22]	<150 μ s, typical
Current mode, full-scale step, 1 μ A range ^[22]	<300 μ s, typical

The following figures illustrate the effect of the transient response setting on the step response of the PXIe-4139 for different loads.

Figure 1. 1 mA Range, No Load Step Response, Nominal

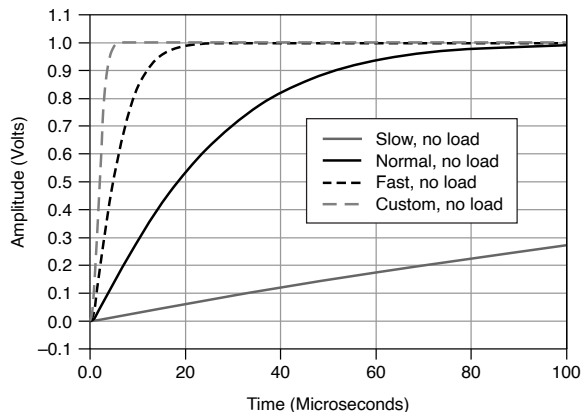
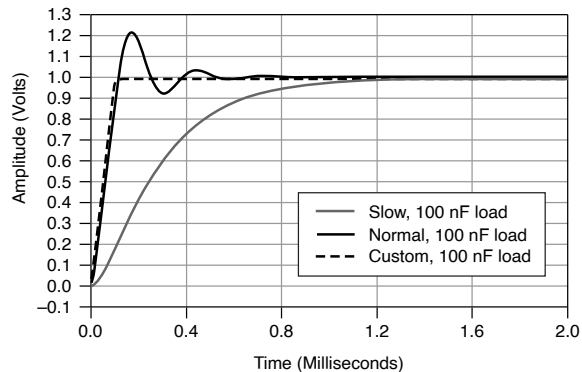

Figure 1. 1 mA Range, 100 nF Load Step Response, Nominal



Load Regulation

Voltage	
Device configured for local sense	100 μ V per mA of output load change (measured between output channel terminals), typical
Device configured for remote sense	Load regulation effect included in voltage accuracy specifications
Current, device configured for local or remote sense	Load regulation effect included in current accuracy specifications

Related reference

- [Voltage](#)
- [Current](#)

Measurement and Update Timing Characteristics

Available sample rates ^[23]	(1.8 MS/s)/ N where N = 1, 2, 3, ... 2 ²⁴ , nominal
Sample rate accuracy	Equal to PXIe_CLK100 accuracy, nominal
Maximum measure rate to host	1.8 MS/s per channel, continuous, nominal
Maximum source update rate^[24]	
Sequence mode	100,000 updates/s (10 μ s/update), nominal
Timed output mode	80,000 updates/s (12.5 μ s/update), nominal
Input trigger to	

Source event delay	10 μ s, nominal
Source event jitter	1 μ s, nominal
Measure event jitter	1 μ s, nominal
Shutdown ^[25]	100 μ s, typical
Pulse mode timing and accuracy^[26]	
Minimum pulse on time^[27]	
PXIe-4139 (40W) ^[28]	10 μ s, nominal
PXIe-4139 (20W)	50 μ s, nominal
Minimum pulse off time ^[29]	50 μ s, nominal
Pulse on time or off time programming resolution	100 ns, nominal
Pulse on time or off time programming accuracy	± 5 μ s, nominal
Pulse on time or off time jitter	1 μ s, nominal

Remote Sense

Voltage accuracy	Add (3 ppm of voltage range + 11 μ V) per volt of HI lead drop plus 1 μ V per volt of lead drop per Ω of corresponding sense lead resistance to voltage accuracy specifications.
Maximum sense lead resistance	100 Ω

Maximum lead drop per lead	3 V, characteristic
----------------------------	---------------------



Note Exceeding the maximum lead drop per lead value may result in additional error.

Examples of Calculating Accuracy



Note Specifications listed in examples are for demonstration purposes only and do not necessarily reflect specifications for this device.

Example 1: Calculating 5 °C Accuracy

Calculate the accuracy of 900 nA output in the 1 μ A range under the following conditions:

ambient temperature	28 °C
internal device temperature	within $T_{cal} \pm 5 \text{ °C}$
self-calibration	within the last 24 hours.

Solution

Since the device internal temperature is within $T_{cal} \pm 5 \text{ °C}$ and the ambient temperature is within $23 \text{ °C} \pm 5 \text{ °C}$, the appropriate accuracy specification is:

$$0.03\% + 100 \text{ pA}$$

Calculate the accuracy using the following equation:

$$\begin{aligned} \text{Accuracy} &= 900 \text{ nA} * 0.03\% + 100 \text{ pA} \\ &= 270 \text{ pA} + 100 \text{ pA} \end{aligned}$$

$$= 370 \text{ pA}$$

Therefore, the actual output will be within 370 pA of 900 nA.

Example 2: Calculating 1 °C Accuracy

Calculate the accuracy of 900 nA output in the 1 μ A range. Assume the same conditions as in Example 1, with the following differences:

internal device temperature	within $T_{cal} \pm 1 \text{ }^{\circ}\text{C}$
-----------------------------	---

Solution

Since the device internal temperature is within $T_{cal} \pm 1 \text{ }^{\circ}\text{C}$ and the ambient temperature is within $23 \text{ }^{\circ}\text{C} \pm 5 \text{ }^{\circ}\text{C}$, the appropriate accuracy specification is:

$$0.022\% + 40 \text{ pA}$$

Calculate the accuracy using the following equation:

$$\text{Accuracy} = 900 \text{ nA} * 0.022\% + 40 \text{ pA}$$

$$= 238 \text{ pA}$$

Therefore, the actual output will be within 238 pA of 900 nA.

Example 3: Calculating Remote Sense Accuracy

Calculate the remote sense accuracy of 500 mV output in the 600 mV range. Assume the same conditions as in Example 2, with the following differences:

HI path lead drop	3 V
HI sense lead resistance	2 Ω
LO path lead drop	2.5 V
LO sense lead resistance	1.5 Ω

Solution

Since the device internal temperature is within $T_{cal} \pm 1\text{ }^{\circ}\text{C}$ and the ambient temperature is within $23\text{ }^{\circ}\text{C} \pm 5\text{ }^{\circ}\text{C}$, the appropriate accuracy specification is:

$$0.016\% + 30\text{ }\mu\text{V}$$

Since the device is using remote sense, use the remote sense accuracy specification:

Add (3 ppm of voltage range + 11 μV) per volt of HI lead drop plus 1 μV per volt of lead drop per Ω of corresponding sense lead resistance to voltage accuracy specifications.

Calculate the remote sense accuracy using the following equation:

$$\begin{aligned} \text{Accuracy} &= \left(500\text{ mV} * 0.016\% + 30\mu\text{V}\right) + \frac{600\text{ mV} * 3\text{ppm} + 11\mu\text{V}}{1\text{Vof lead drop}} * 3\text{V} + \frac{1\mu\text{V}}{\text{V} * \Omega} * 3\text{V} \\ &* 2\Omega + \frac{1\mu\text{V}}{\text{V} * \Omega} * 2.5\text{V} * 1.5\Omega \\ &= 80\mu\text{V} + 30\mu\text{V} + 12.8\mu\text{V} * 3 + 6\mu\text{V} + 3.8\mu\text{V} \\ &= 158.2\mu\text{V} \end{aligned}$$

Therefore, the actual output will be within 158.2 μV of 500 mV.

Example 4: Calculating Accuracy with Temperature Coefficient

Calculate the accuracy of 900 nA output in the 1 μA range. Assume the same conditions as in Example 2, with the following differences:

ambient temperature	15 $^{\circ}\text{C}$
---------------------	-----------------------

Solution

Since the device internal temperature is within $T_{cal} \pm 1\text{ }^{\circ}\text{C}$, the appropriate accuracy specification is:

$$0.022\% + 40\text{ pA}$$

Since the ambient temperature falls outside of $23\text{ }^{\circ}\text{C} \pm 5\text{ }^{\circ}\text{C}$, use the following temperature coefficient per degree Celsius outside the $23\text{ }^{\circ}\text{C} \pm 5\text{ }^{\circ}\text{C}$ range:

$$0.0006\% + 4\text{ pA}$$

Calculate the accuracy using the following equation:

$$\text{TemperatureVariation} = (23^{\circ}\text{C} - 5\text{ }^{\circ}\text{C}) - 15^{\circ}\text{C} = 3^{\circ}\text{C}$$

$$\text{Accuracy} = (900\text{ nA} * 0.022\% + 40\text{ pA}) + \frac{900\text{ nA} * 0.0006\% + 4\text{pA}}{1^{\circ}\text{C}} * 3^{\circ}\text{C}$$

$$= 238\text{ pA} + 28.2\text{ pA}$$

$$= 266.2\text{ pA}$$

Therefore, the actual output will be within 266.2 pA of 900 nA.

Examples of Determining Extended Range Pulse Parameters and Optimizing Slew Rate using NI SourceAdapt



Note Specifications listed in examples are for demonstration purposes only and do not necessarily reflect specifications for this device.

Example 1: Determining Extended Range Pulse On Time and Duty Cycle Parameters for the PXIe-4139 (40W)

Determine the extended range pulsing parameters, assuming the following operating point.

Output function	Pulse Current
-----------------	---------------

Pulse voltage limit, V_{pulse}	40 V
Pulse current level, I_{pulse}	6 A
Bias voltage limit, V_{bias}	0.1 V
Bias current level, I_{bias}	0 A
Pulse on time, t_{on}	1.5 ms
Chassis' slot cooling capacity	≥ 58 W

Solution

Begin by calculating the pulse power using the following equation.

$$\begin{aligned} \text{Pulse power} &= V_{\text{pulse}} * I_{\text{pulse}} \\ &= 40 \text{ V} * 6 \text{ A} \\ &= 240 \text{ W} \end{aligned}$$

For PXIe-4139 (40W), refer to the following figures to identify next steps. First, verify the the region of operation using [Figure 1](#), which shows 240 W is in the extended range pulsing region.

Next, refer to [Figure 1](#), which shows the maximum pulse on time, t_{on} , is limited by the maximum pulse energy, E_{pulseMax} . Use the pulse energy equation (**Equation 2**) from [Table 1](#) to calculate the maximum pulse on time, t_{onMax} (**Equation 6**).

$$\begin{aligned} t_{\text{onMax}} &= \left| \frac{E_{\text{pulseMax}}}{V_{\text{pulse}} * I_{\text{pulse}}} \right| \quad (\text{Eq.6}) \\ &= \left| \frac{0.4 \text{ J}}{40 \text{ V} * 6 \text{ A}} \right| \\ &= 1.67 \text{ ms} \end{aligned}$$

Next, refer to [Figure 2](#), which shows the maximum duty cycle, D , is limited by the cycle average power, P_{CA} . If the required pulse on time is 1.5 ms and the module is installed in a chassis with slot cooling capacity ≥ 58 W, use the cycle average power equation (**Equation 5**) from [Table 1](#) to calculate the minimum pulse off time, t_{offMin} (**Equation 7**).

$$t_{\text{offMin}} = \left| \frac{P_{\text{CA}} * t_{\text{on}} - V_{\text{pulse}} * I_{\text{pulse}} * t_{\text{on}}}{P_{\text{CA}} - V_{\text{bias}} * I_{\text{bias}}} \right| \quad (\text{Eq.7})$$

$$= \left\lceil \frac{40 \text{ W} * 1.5 \text{ ms} - 40 \text{ V} * 6 \text{ A} * 1.5 \text{ ms}}{40 \text{ W} - 0.1 \text{ V} * 0 \text{ A}} \right\rceil$$

$$= 7.5 \text{ ms}$$

Finally, verify that the pulse cycle time, t_{cycle} , is greater than or equal to the minimum pulse cycle time, t_{cycleMin} (5 ms). To calculate the pulse cycle time, use the following equation:

$$t_{\text{cycle}} = t_{\text{on}} + t_{\text{off}} \quad (\text{Eq. 4})$$

$$= 1.5 \text{ ms} + 7.5 \text{ ms}$$

$$= 9 \text{ ms}$$

In this case, the pulse cycle time meets the minimum pulse cycle time specification.

Therefore, a 40 V, 6 A pulse with an on time of 1.5 ms and a pulse off time of 7.5 ms is supported, since it fulfills the following criteria:

- Greater than the minimum pulse on time of 10 μs
- Equal to the minimum pulse off time of 7.5 ms to meet maximum cycle average power
- Greater than the minimum pulse cycle time of 5 ms

Example 2: Determining Extended Range Pulse On Time and Duty Cycle Parameters for the PXIe-4139 (20W)

Determine the extended range pulsing parameters, assuming the following operating point.

Output function	Pulse Current
Pulse voltage limit, V_{pulse}	40 V
Pulse current level, I_{pulse}	6 A
Bias voltage limit, V_{bias}	0.1 V
Bias current level, I_{bias}	0 A
Pulse on time, t_{on}	1.5 ms

Chassis' slot cooling capacity

≥58 W

Solution

Begin by calculating the pulse power using the following equation.

$$\begin{aligned} \text{Pulse power} &= V_{\text{pulse}} * I_{\text{pulse}} \\ &= 40 \text{ V} * 6 \text{ A} \\ &= 240 \text{ W} \end{aligned}$$

Since the pulse power of 240 W is within the 500 W region of [Figure 2](#), the maximum configurable on time is 400 μs and maximum duty cycle is 2%.

For example, if the required pulse on time is 100 μs, and the required pulse cycle time is 10 ms, calculate the pulse off time and verify the duty cycle using the following equations.

$$\begin{aligned} t_{\text{off}} &= t_{\text{cycle}} - t_{\text{on}} \\ &= 10 \text{ ms} - 100 \mu\text{s} \\ &= 9.9 \text{ ms} \end{aligned}$$

$$\begin{aligned} \text{Duty cycle} &= \frac{t_{\text{on}}}{t_{\text{cycle}}} * 100\% \\ &= 1\% \end{aligned}$$

Therefore, a pulse with an on time of 100 μs and 1% duty cycle would be supported, since it fulfills the following criteria:

- Greater than the minimum pulse on time of 50 μs
- Less than the maximum pulse on time of 400 μs and duty cycle of 2%
- Greater than the minimum pulse cycle time of 5 ms

Example 3: Using NI SourceAdapt to Increase the Slew Rate of the Pulse

Determine the appropriate operating parameters and custom transient response settings, assuming the following example parameters.

Output function	Pulse Current
Pulse voltage limit, V_{pulse}	50 V
Pulse current level, I_{pulse}	5 A
Bias voltage limit, V_{bias}	0.1 V
Bias current level, I_{bias}	0 A
Transient response	Fast
Load, cable impedance	4.5 Ω , 40 μH
Pulse on time, t_{on}	10 μs
Pulse off time, t_{off}	4.99 ms

The SMU Transient Response can be configured to three predefined settings, Slow, Normal, and Fast. If these settings do not provide the desired pulse response, a fourth setting, Custom, enables NI SourceAdapt^[31] technology which provides the ability to customize the SMU response to any load, and achieve an ideal response with minimum rise times and no overshoots or oscillations.

Figure 11. 10 μs Pulse Output with Load, Fast Transient Response

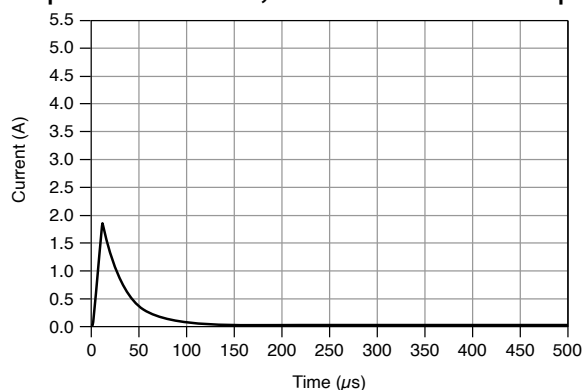

Solution

SourceAdapt allows users to set the desired gain bandwidth, compensation frequency, and pole-zero ratio through custom transient response to obtain the desired pulse waveform. To use SourceAdapt, first set the Transient Response to Custom.

To achieve the resulting waveform in the following figure, use the parameters in the following table.

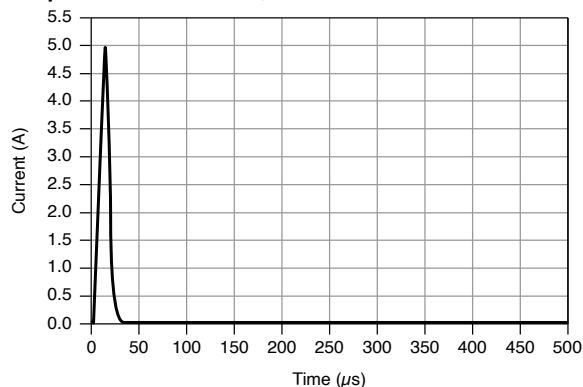
Figure 12. 10 μ s Pulse Output with Load, Custom Transient Response

Transient response	Custom
Current: Gain bandwidth	260 kHz
Current: Compensation frequency	140 kHz
Current: Pole-zero ratio	0.75

Gain bandwidth is directly proportional to the step response slew rate. The higher the gain bandwidth, the higher the slew rate. It is worth noting that increasing the gain bandwidth will likely increase ringing. However, this can likely be removed by appropriately setting the compensation frequency and the pole-zero ratio.

Figure 13. Example of Ringing Frequency

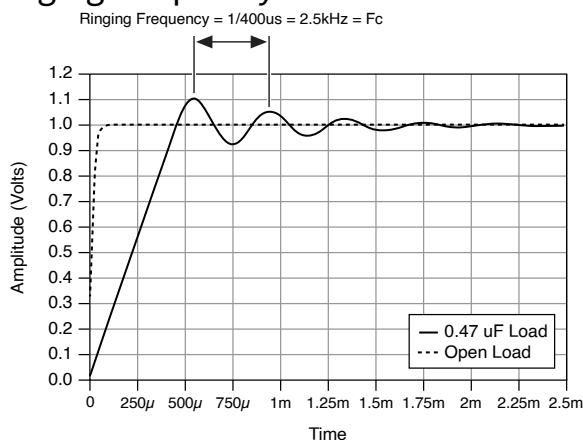

Compensation frequency and pole-zero ratio are used to determine the frequencies of the SMU control loop pole and zero, which can be used to optimize the system transient response by increasing phase margin and reducing ringing. To reduce the overshoot, it is recommended to set the compensation frequency close to the

overshoot ringing frequency, see F_c in [Figure 3](#), and set the pole-zero ratio to be greater than 1.

For reference, the pole frequency and zero frequency are derived by the following equations.

$$\text{Pole frequency} = \text{Compensation frequency} * \sqrt{\text{Pole-zero ratio}}$$

$$\text{Zero frequency} = \frac{\text{Compensation frequency}}{\text{Pole-zero ratio}}$$

These settings can be accessed through the Transient Response set to Custom: Voltage or Current.

Trigger Characteristics

Input triggers

Types Start, Source, Sequence Advance, Measure, Pulse; Shutdown

Sources (PXI trigger lines <0...7>)

Polarity Configurable

Minimum pulse width 100 ns, nominal

Destinations^[33] (PXI trigger lines <0...7>)

Polarity Active high (not configurable)

Pulse width >200 ns, typical

Output triggers (events)

Types Source Complete, Sequence Iteration Complete, Sequence Engine Done, Measure Complete, Pulse Complete, Ready for Pulse

Destinations (PXI trigger lines <0...7>)

Polarity Configurable

Pulse width Configurable between 250 ns and 1.6 μ s, nominal

Protection

Output channel protection

Overcurrent or overvoltage Automatic shutdown, output disconnect relay opens

Overtemperature Automatic shutdown, output disconnect relay opens

Safety Voltage and Current



Notice The protection provided by the PXIe-4139 can be impaired if it is used in a manner not described in the user documentation.

Warning Take precautions to avoid electrical shock when operating this product at hazardous voltages.



Caution Isolation voltage ratings apply to the voltage measured between any channel pin and the chassis ground. When operating channels in series or floating on top of external voltage references, ensure that no terminal exceeds this rating.



Attention Les tensions nominales d'isolation s'appliquent à la tension mesurée entre n'importe quelle broche de voie et la masse du châssis. Lors de l'utilisation de voies en série ou flottantes en plus des références de tension externes, assurez-vous qu'aucun terminal ne dépasse cette valeur nominale.

DC voltage	±60 V
Channel-to-earth ground isolation	
Continuous	150 VDC, CAT I
Withstand	1,000 V RMS, verified by a 5 s withstand



Caution Do not connect the PXIe-4139 to signals or use for measurements within Measurement Categories II, III, or IV.



Attention Ne connectez pas le PXIe-4139 à des signaux et ne l'utilisez pas pour effectuer des mesures dans les catégories de mesure II, III ou IV.

Measurement Category I is for measurements performed on circuits not directly connected to the electrical distribution system referred to as **MAINS** voltage. MAINS is a hazardous live electrical supply system that powers equipment. This category is for measurements of voltages from specially protected secondary circuits. Such voltage measurements include signal levels, special equipment, limited-energy parts of equipment, circuits powered by regulated low-voltage sources, and electronics.



Note Measurement Categories CAT I and CAT O are equivalent. These test and measurement circuits are for other circuits not intended for direct connection to the MAINS building installations of Measurement Categories CAT II, CAT III, or CAT IV.

DC current range	±3 A ±10 A, pulse only
------------------	---------------------------

Guard Output Characteristics

Cable guard	
Output impedance	2 kΩ, nominal
Offset voltage	1 mV, typical

Calibration Interval

Recommended calibration interval	1 year
----------------------------------	--------

Power Requirement

PXI Express power requirement	
PXIe-4139 (40W)	3.0 A from the 3.3 V rail and 6.0 A from the 12 V rail
PXIe-4139 (20W)	2.5 A from the 3.3 V rail and 2.2 A from the 12 V rail

Physical

Dimensions	3U, one-slot, PXI Express/CompactPCI Express module 2.0 cm × 13.0 cm × 21.6 cm (0.8 in. × 5.1 in. × 8.5 in.)
Weight	

PXIe-4139 (40W)	427 g (15.1 oz)
PXIe-4139 (20W)	419 g (14.8 oz)
Front panel connectors	5.08 mm (8 position)

Environmental Guidelines



Notice This product is intended for use in indoor applications only.



Notice Cover all empty slots using filler panels.

Environmental Characteristics

Temperature	
Operating	0 °C to 55 °C
Storage	-40 °C to 71 °C
Humidity	
Operating	10% to 90%, noncondensing
Storage	5% to 95%, noncondensing
Pollution Degree	2
Maximum altitude	2,000 m (800 mbar) (at 25 °C ambient temperature)
Shock and Vibration	

Operating vibration	5 Hz to 500 Hz, 0.3 g RMS
Non-operating vibration	5 Hz to 500 Hz, 2.4 g RMS
Operating shock	30 g, half-sine, 11 ms pulse

Environmental Standards

This product meets the requirements of the following environmental standards for electrical equipment.

- IEC 60068-2-1 Cold
- IEC 60068-2-2 Dry heat
- IEC 60068-2-78 Damp heat (steady state)
- IEC 60068-2-64 Random operating vibration
- IEC 60068-2-27 Operating shock



Note To verify marine approval certification for a product, refer to the product label or visit ni.com/certification and search for the certificate.

Safety Compliance Standards

This product is designed to meet the requirements of the following electrical equipment safety standards for measurement, control, and laboratory use:

- IEC 61010-1, EN 61010-1
- UL 61010-1, CSA C22.2 No. 61010-1



Note For safety certifications, refer to the product label or the [Product Certifications and Declarations](#) section.

Electromagnetic Compatibility

This product meets the requirements of the following EMC standards for electrical equipment for measurement, control, and laboratory use:

- EN 61326-1 (IEC 61326-1): Class A emissions; Basic immunity
- EN 55011 (CISPR 11): Group 1, Class A emissions
- AS/NZS CISPR 11: Group 1, Class A emissions



Note Group 1 equipment (per CISPR 11) is any industrial, scientific, or medical equipment that does not intentionally generate radio frequency energy for the treatment of material or inspection/analysis purposes.



Note For EMC declarations, certifications, and additional information, refer to the [Product Certifications and Declarations](#) section.

Environmental Management

NI is committed to designing and manufacturing products in an environmentally responsible manner. NI recognizes that eliminating certain hazardous substances from our products is beneficial to the environment and to NI customers.

For additional environmental information, refer to the **Engineering a Healthy Planet** web page at ni.com/environment. This page contains the environmental regulations and directives with which NI complies, as well as other environmental information not included in this document.

EU and UK Customers

-  **Waste Electrical and Electronic Equipment (WEEE)**—At the end of the product life cycle, all NI products must be disposed of according to local laws and regulations. For more information about how to recycle NI products in your region, visit ni.com/environment/weee.

电子信息产品污染控制管理办法 (中国 RoHS)

-  中国 RoHS— NI 符合中国电子信息产品中限制使用某些有害物质指令(RoHS)。关于 NI 中国 RoHS 合规性信息，请登录 ni.com/environment/rohs_china。(For information about China RoHS compliance, go to ni.com/environment/rohs_china.)

Product Certifications and Declarations

Refer to the product Declaration of Conformity (DoC) for additional regulatory compliance information. To obtain product certifications and the DoC for NI products, visit ni.com/product-certifications, search by model number, and click the appropriate link.

NI Services

Visit ni.com/support to find support resources including documentation, downloads, and troubleshooting and application development self-help such as tutorials and examples.

Visit ni.com/services to learn about NI service offerings such as calibration options, repair, and replacement.

Visit ni.com/register to register your NI product. Product registration facilitates technical support and ensures that you receive important information updates from NI.

NI corporate headquarters is located at 11500 N Mopac Expwy, Austin, TX, 78759-3504, USA.

¹ The ambient temperature of a PXI system is defined as the temperature at the chassis fan inlet (air intake).

² For increased capability, NI recommends installing the PXIe-4139 (40W) in a chassis with slot cooling capacity ≥ 58 W.

³ The PXIe-4139 does not support configurations involving voltage $> |42.4$ V| when Sequence Step Delta Time Enabled is set to True.

⁴ Power limit defined by voltage measured between HI and LO terminals.

⁵ Accuracy is specified for no load output configurations. Refer to **Load Regulation** and **Remote Sense** sections for additional accuracy derating and conditions.

⁶ T_{cal} is the internal device temperature recorded by the PXIe-4139 at the completion of the last self-calibration.

⁷ T_{cal} is the internal device temperature recorded by the PXIe-4139 at the completion of the last self-calibration.

⁸ T_{cal} is the internal device temperature recorded by the PXIe-4139 at the completion of the last self-calibration.

⁹ For example, given a continuous pulsin load, if the largest dynamic step in power that the load sources/sinks is from 5 W to 15 W, then the maximum SMU power step is 10 W. Thus, the minimum dynamic load pulse cycle time is 250 μ s.

¹⁰ Extended range pulses fall outside DC range limits for either current or power. In-range pulses fall within DC range limits and are not subject to extended range pulsing limitations. Extended range pulsing is enabled by setting the Output Function to Pulse Voltage or Pulse Current.

¹¹ **Pulse on time** is measured from the start of the leading edge to the start of the trailing edge. See [Figure 1](#).

¹² Refer to [Figure 1](#) to estimate the value and determine the limiting equation.

¹³ Refer to [Figure 2](#) to estimate the value and determine the limiting equation. If $D \geq 100\%$, consider switching Output Function from Pulse mode to DC mode.

- 14 Refer to [Figure 2](#) to estimate the value and determine the limiting equation.
- 15 Extended range pulses fall outside DC range limits for either current or power. In-range pulses fall within DC range limits and are not subject to extended range pulsing limitations. Extended range pulsing is enabled by configuring the Output Function to Pulse Voltage or Pulse Current.
- 16 **Pulse on time** is measured from the start of the leading edge to the start of the trailing edge. See [Figure 1](#).
- 17 Optimize transient response, overshoot, and slew rate with NI SourceAdapt by adjusting the Transient Response.
- 18 To improve the slew rate, see [Examples of Determining Extended Range Pulse Parameters and Optimizing Slew Rate using NI SourceAdapt](#).
- 19 Measured as the time to settle to within 0.1% of step amplitude, device configured for fast transient response.
- 20 Current limit set to $\geq 50 \mu\text{A}$ and $\geq 50\%$ of the selected current limit range.
- 21 Current limit set to $\geq 20 \mu\text{A}$ and $\geq 20\%$ of selected current limit range.
- 22 Voltage limit set to $\geq 2 \text{ V}$, resistive load set to $1 \text{ V}/\text{selected current range}$.
- 23 When sourcing while measuring, both the Source Delay and Aperture Time affect the sampling rate. When taking a measure record, only the Aperture Time affects the sampling rate.
- 24 As the source delay is adjusted or if advanced sequencing is used, maximum source rates vary. Timed output mode is enabled in Sequence Mode by setting the Sequence Step Delta Time Enabled to True. Additional timing limitations apply when operating in pulse mode (Output Function is set to Pulse Voltage or Pulse Current).
- 25 Time from PXI Trigger sent until SMU output goes to high impedance.

²⁶ Pulse mode is enabled when the Output Function is set to Pulse Voltage or Pulse Current. This mode enables access to extended range pulsing capabilities. For PXIe-4139 (20W), shorter minimum on times for in-range pulses can be achieved using Sequence mode or Timed Output mode with the Output Function set to Voltage or Current.

²⁷ **Pulse on time** is measured from the start of the leading edge to the start of the trailing edge. See [Figure 1](#).

²⁸ Optimize transient response, overshoot, and slew rate with NI SourceAdapt by adjusting the Transient Response.

²⁹ Pulses fall inside DC limits. **Pulse off time** is measured from the start of the trailing edge to the start of a subsequent leading edge.

³⁰ T_{cal} is the internal device temperature recorded by the PXIe-4139 at the completion of the last self-calibration.

³¹ Visit ni.com for more information about NI SourceAdapt Next-Generation SMU Technology.

³² Pulse widths and logic levels are compliant with **PXI Express Hardware Specification Revision 1.0 ECN 1**.

³³ Input triggers can be re-exported.