

881624-1 ✓ ACTIVE

FASTON | FASTON 187

TE Internal #: 881624-1

Quick Disconnects, Receptacle, 17 – 14 AWG Wire Size, 1.03 – 2.62 mm² Wire Size, Mating Tab Width 4.75 mm [.187 in], Straight, Brass, FASTON 187

[View on TE.com >](#)



Terminals & Splices > Quick Disconnects



Quick Disconnect Terminal Type: **Receptacle**

Wire Size: **1.03 – 2.62 mm²**

Mating Tab Width: **4.75 mm [.187 in]**

Mating Tab Thickness: **.81 mm [.032 in]**

Features

Product Type Features

Insertion Force	Normal
-----------------	--------

Contact Features

Quick Disconnect Terminal Type	Receptacle
--------------------------------	------------

Mating Tab Width	4.75 mm [.187 in]
------------------	-------------------

Mating Tab Thickness	.81 mm [.032 in]
----------------------	------------------

Terminal Orientation	Straight
----------------------	----------

Contact Base Material	Brass
-----------------------	-------

Terminal Plating Material	Unplated
---------------------------	----------

Crimp Type	F-Crimp
------------	---------

Barrel Type	Open
-------------	------

Mechanical Attachment

Wire Insulation Support	With
-------------------------	------

Dimensions

Terminal Material Thickness	.3 mm [.012 in]
-----------------------------	-----------------



Compatible Insulation Diameter Range	2.7 – 4 mm [.106 – .157 in]
--------------------------------------	-----------------------------

Wire Size	1.03 – 2.62 mm ²
-----------	-----------------------------

Usage Conditions

Insulation Option	Uninsulated
-------------------	-------------

Operating Temperature Range	-40 – 110 °C [-40 – 230 °F]
-----------------------------	-----------------------------

Packaging Features

Packaging Quantity	10000
--------------------	-------

Packaging Method	Strip/Reel
------------------	------------

Product Compliance

[For compliance documentation, visit the product page on TE.com>](#)

EU RoHS Directive 2011/65/EU	Compliant
------------------------------	-----------

EU ELV Directive 2000/53/EC	Compliant
-----------------------------	-----------

China RoHS 2 Directive MIIT Order No 32, 2016	No Restricted Materials Above Threshold
---	---

EU REACH Regulation (EC) No. 1907/2006	Current ECHA Candidate List: JUNE 2023 (235) Candidate List Declared Against: JUNE 2022 (224) Does not contain REACH SVHC
--	---

Halogen Content	Low Halogen - Br, Cl, F, I < 900 ppm per homogenous material. Also BFR/CFR/PVC Free
-----------------	---

Solder Process Capability	Not applicable for solder process capability
---------------------------	--

Product Compliance Disclaimer

This information is provided based on reasonable inquiry of our suppliers and represents our current actual knowledge based on the information they provided. This information is subject to change. The part numbers that TE has identified as EU RoHS compliant have a maximum concentration of 0.1% by weight in homogenous materials for lead, hexavalent chromium, mercury, PBB, PBDE, DBP, BBP, DEHP, DIBP, and 0.01% for cadmium, or qualify for an exemption to these limits as defined in the Annexes of Directive 2011/65/EU (RoHS2). Finished electrical and electronic equipment products will be CE marked as required by Directive 2011/65/EU. Components may not be CE marked. Additionally, the part numbers that TE has identified as EU ELV compliant have a maximum concentration of 0.1% by weight in homogenous materials for lead, hexavalent chromium, and mercury, and 0.01% for cadmium, or qualify for an exemption to these limits as defined in the Annexes of Directive 2000/53/EC (ELV). Regarding the REACH Regulation, the information TE provides on SVHC in articles for this part number is based on the latest European Chemicals Agency (ECHA) 'Guidance on requirements for substances in articles' posted at this URL: <https://echa.europa.eu/guidance-documents/guidance-on-reach>

Compatible Parts



Also in the Series | **FASTON 187**

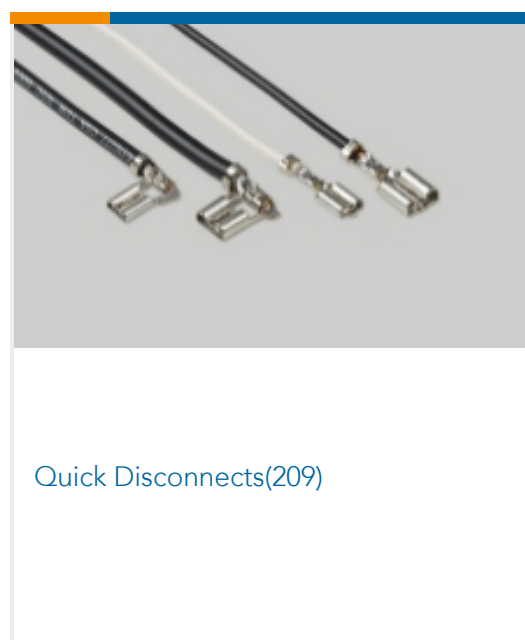
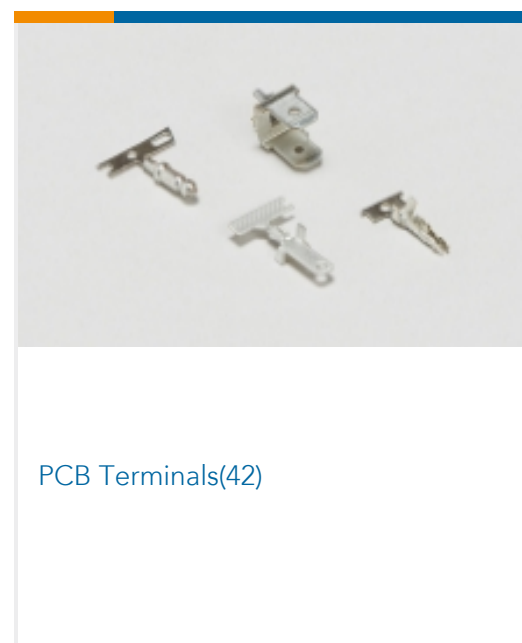
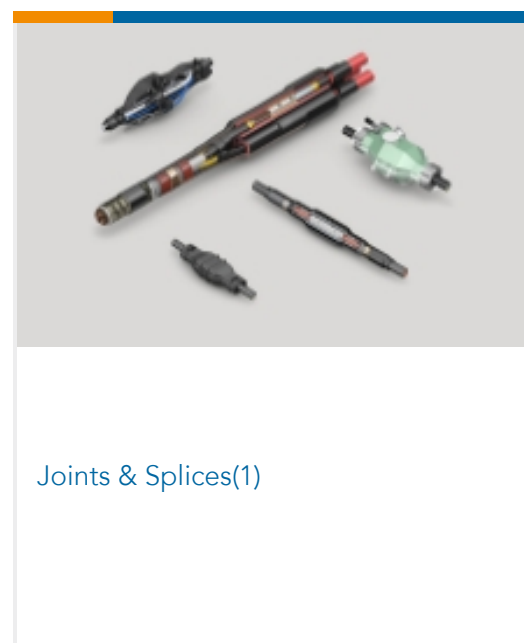
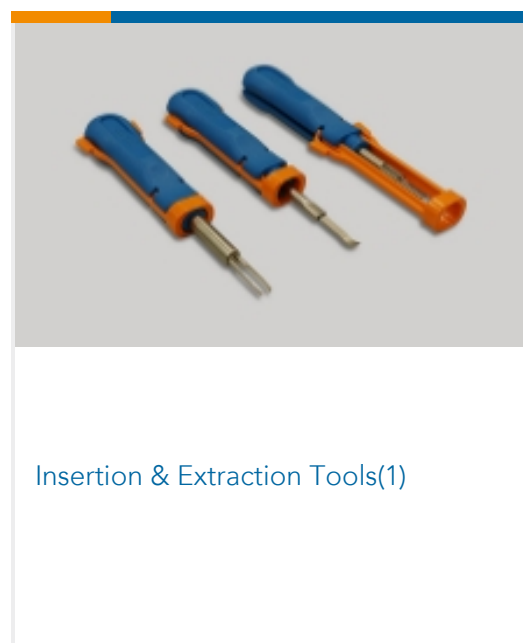
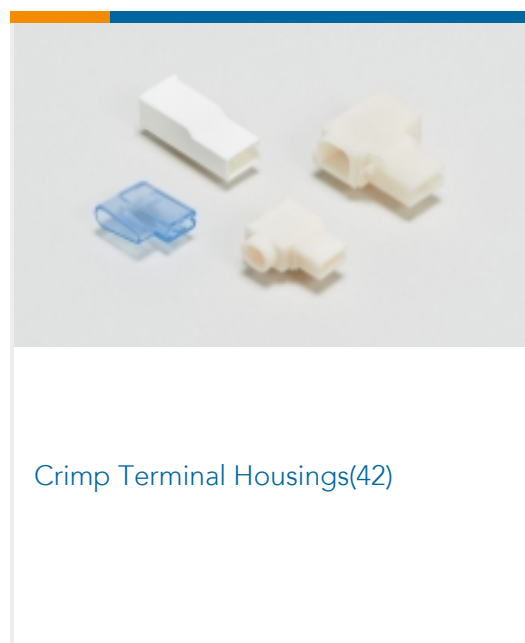

Customers Also Bought

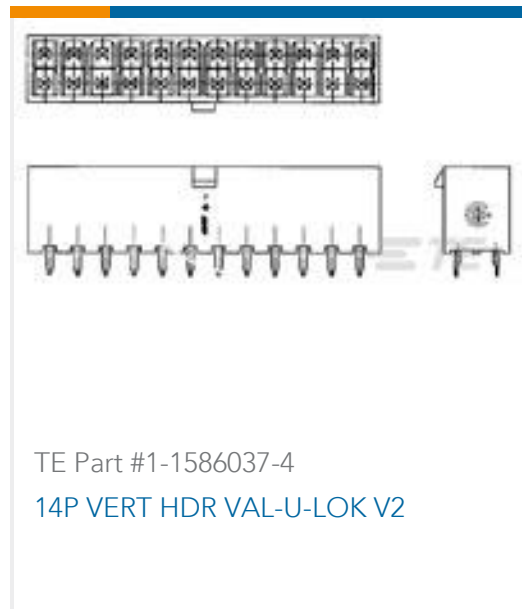
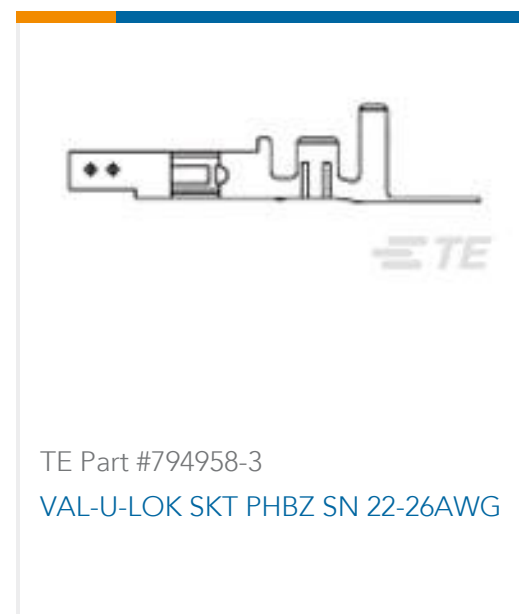
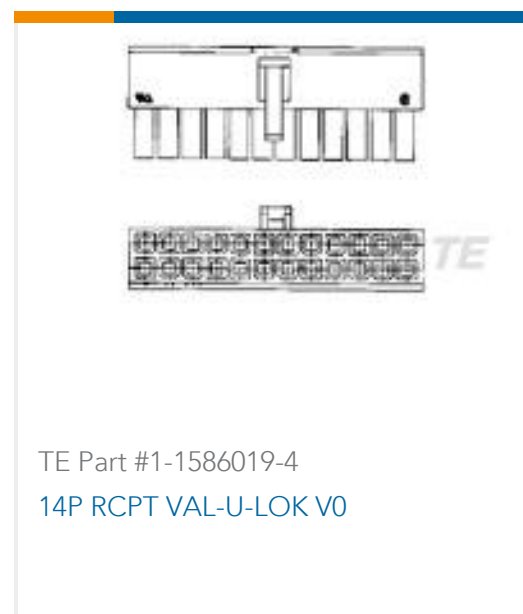

Documents

Product Drawings

[187 FASTON REC 17-14 AWG BR](#)

English

CAD Files

[3D PDF](#)

3D

Customer View Model

[ENG_CVM_CVM_881624-1_K_c-881624-1-k.2d_dxf.zip](#)

English

Customer View Model

[ENG_CVM_CVM_881624-1_K_c-881624-1-k.3d_igs.zip](#)

English

Customer View Model

[ENG_CVM_CVM_881624-1_K_c-881624-1-k.3d_stp.zip](#)

English

By downloading the CAD file I accept and agree to the [Terms and Conditions](#) of use.

Product Specifications

[.110,.187 & 250 Series FASTON Terminals](#)

English

Product Specification

English

Product Environmental Compliance

[MD_881624-1_04182014440_dmtec](#)

English

881624-1

Quick Disconnects, Receptacle, 17 – 14 AWG Wire Size, 1.03 – 2.62 mm² Wire Size,
Mating Tab Width 4.75 mm [.187 in], Straight, Brass, FASTON 187



[MD_881624-1_04182014440_dmtec](#)

English