

# UT 35 IB BU - Feed-through terminal block



3047730

<https://www.phoenixcontact.com/us/products/3047730>

Please be informed that the data shown in this PDF document is generated from our online catalog. Please find the complete data in the user documentation. Our general terms of use for downloads are valid.



Feed-through terminal block, with Allen screws, nom. voltage: 1000 V, nominal current: 125 A, number of connections: 2, connection method: Screw connection, Rated cross section: 35 mm<sup>2</sup>, cross section: 1.5 mm<sup>2</sup> - 50 mm<sup>2</sup>, mounting type: NS 35/7,5, NS 35/15, color: blue

## Your advantages

- The flexible options for reducing bridging in the CLIPLINE complete system can be found in "Accessories for the CLIPLINE complete modular terminal block system"
- The reducing bridges can be used to connect terminal blocks with different connection technologies, e.g., UT 35 screw terminal block with Push-in technology 2,5 Push-in terminal blocks, to form power blocks

## Commercial data

Item number	3047730
Packing unit	1 pc
Minimum order quantity	50 pc
Sales key	BE01
Product key	BE1111
GTIN	4046356178488
Weight per piece (including packing)	58.692 g
Weight per piece (excluding packing)	58.692 g
Customs tariff number	85369010
Country of origin	TR

# UT 35 IB BU - Feed-through terminal block



3047730

<https://www.phoenixcontact.com/us/products/3047730>

## Technical data

### Product properties

Product type	Feed-through terminal block
Number of connections	2
Number of rows	1
Potentials	1

### Insulation characteristics

Overvoltage category	III
Degree of pollution	3

### Electrical properties

Rated surge voltage	8 kV
Maximum power dissipation for nominal condition	4.06 W

### Connection data

Number of connections per level	2
Nominal cross section	35 mm <sup>2</sup>

### Level 1 above 1 below 1

Screw thread	M6
Tightening torque	3.2 ... 3.7 Nm
Stripping length	18 mm
Internal cylindrical gage	B9
Connection in acc. with standard	IEC 60947-7-1
Conductor cross section rigid	1.5 mm <sup>2</sup> ... 50 mm <sup>2</sup>
Cross section AWG	16 ... 1/0 (converted acc. to IEC)
Conductor cross section flexible	1.5 mm <sup>2</sup> ... 50 mm <sup>2</sup>
Conductor cross section, flexible [AWG]	16 ... 1 (converted acc. to IEC)
Conductor cross-section flexible (ferrule without plastic sleeve)	1.5 mm <sup>2</sup> ... 35 mm <sup>2</sup>
Flexible conductor cross section (ferrule with plastic sleeve)	1.5 mm <sup>2</sup> ... 35 mm <sup>2</sup>
Conductor cross-section flexible (2 conductors with the same cross-section, with TWIN ferrule and plastic sleeve)	1.5 mm <sup>2</sup> ... 10 mm <sup>2</sup>
2 conductors with same cross section, solid	1.5 mm <sup>2</sup> ... 16 mm <sup>2</sup>
2 conductors with same cross section, flexible	1.5 mm <sup>2</sup> ... 10 mm <sup>2</sup>
2 conductors with same cross section, flexible, with ferrule without plastic sleeve	1.5 mm <sup>2</sup> ... 10 mm <sup>2</sup>
2 conductors with the same cross section, flexible, with TWIN ferrule with plastic sleeve	1.5 mm <sup>2</sup> ... 16 mm <sup>2</sup>
Nominal current	125 A
Maximum load current	150 A (with 50 mm <sup>2</sup> conductor cross section)
Nominal voltage	1000 V
Note	Note: Product releases, connection cross sections and notes on connecting aluminum cables can be found in the download area.

# UT 35 IB BU - Feed-through terminal block



3047730

<https://www.phoenixcontact.com/us/products/3047730>

Nominal cross section	35 mm <sup>2</sup>
-----------------------	--------------------

## Ex data

### Rated data (ATEX/IECEX)

Identification	⊕ II 2 GD Ex eb IIC Gb
Operating temperature range	-60 °C ... 110 °C
Ex-certified accessories	1212640 SF-THEX 4-150 3022276 CLIPFIX 35-5 3022218 CLIPFIX 35
List of bridges	Plug-in bridge / FBS 2-16 / 3005963
Bridge data	98.5 A / 35 mm <sup>2</sup>
Ex temperature increase	40 K (133.6 A / 35 mm <sup>2</sup> )
Rated voltage	690 V
for bridging with bridge	690 V
Rated insulation voltage	630 V
output	(Permanent)

### Ex level General

Rated current	123 A
Maximum load current	129 A
Contact resistance	0.08 mΩ

### Ex connection data General

Torque range	3.2 Nm ... 3.7 Nm
Nominal cross section	35 mm <sup>2</sup>
Rated cross section AWG	2
Connection capacity rigid	1.5 mm <sup>2</sup> ... 50 mm <sup>2</sup>
Connection capacity AWG	16 ... 1/0
Connection capacity flexible	1.5 mm <sup>2</sup> ... 35 mm <sup>2</sup>
Connection capacity AWG	16 ... 2
2 conductors with same cross section, solid	1.5 mm <sup>2</sup> ... 16 mm <sup>2</sup>
2 conductors with the same cross-section AWG rigid	16 ... 6
2 conductors with same cross section, stranded	1.5 mm <sup>2</sup> ... 10 mm <sup>2</sup>
2 conductors with the same cross-section AWG flexible	16 ... 8

## Dimensions

Width	16 mm
End cover width	2.2 mm
Height	61.2 mm
Depth	65.1 mm
Depth on NS 35/7,5	65.7 mm
Depth on NS 35/15	73.2 mm

## Material specifications

Color	blue
-------	------

# UT 35 IB BU - Feed-through terminal block



3047730

<https://www.phoenixcontact.com/us/products/3047730>

Flammability rating according to UL 94	V0
Insulating material group	I
Insulating material	PA
Static insulating material application in cold	-60 °C
Temperature index of insulation material (DIN EN 60216-1 (VDE 0304-21))	130 °C
Relative insulation material temperature index (Elec., UL 746 B)	130 °C
Fire protection for rail vehicles (DIN EN 45545-2) R22	HL 1 - HL 3
Fire protection for rail vehicles (DIN EN 45545-2) R23	HL 1 - HL 3
Fire protection for rail vehicles (DIN EN 45545-2) R24	HL 1 - HL 3
Fire protection for rail vehicles (DIN EN 45545-2) R26	HL 1 - HL 3
Calorimetric heat release NFPA 130 (ASTM E 1354)	28 MJ/kg
Surface flammability NFPA 130 (ASTM E 162)	passed
Specific optical density of smoke NFPA 130 (ASTM E 662)	passed
Smoke gas toxicity NFPA 130 (SMP 800C)	passed

## Electrical tests

### Surge voltage test

Test voltage setpoint	9.8 kV
Result	Test passed

### Temperature-rise test

Requirement temperature-rise test	Increase in temperature $\leq$ 45 K
Result	Test passed
Short-time withstand current 35 mm <sup>2</sup>	4.2 kA
Short-time withstand current 50 mm <sup>2</sup>	6 kA
Result	Test passed

### Power-frequency withstand voltage

Test voltage setpoint	2.2 kV
Result	Test passed

## Mechanical properties

### Mechanical data

Open side panel	No
-----------------	----

## Mechanical tests

### Mechanical strength

Result	Test passed
--------	-------------

### Attachment on the carrier

DIN rail/fixing support	NS 35
Test force setpoint	10 N
Result	Test passed

# UT 35 IB BU - Feed-through terminal block



3047730

<https://www.phoenixcontact.com/us/products/3047730>

## Test for conductor damage and slackening

Rotation speed	10 rpm
Revolutions	135
Conductor cross section/weight	1.5 mm <sup>2</sup> / 0.4 kg
	35 mm <sup>2</sup> / 6.8 kg
	50 mm <sup>2</sup> / 9.5 kg
Result	Test passed

## Environmental and real-life conditions

### Needle-flame test

Time of exposure	30 s
Result	Test passed

### Oscillation/broadband noise

Specification	DIN EN 50155 (VDE 0115-200):2008-03
Spectrum	Service life test category 1, class B, body mounted
Frequency	$f_1 = 5 \text{ Hz}$ to $f_2 = 150 \text{ Hz}$
ASD level	1.857 (m/s <sup>2</sup> )/Hz
Acceleration	0.8g
Test duration per axis	5 h
Test directions	X-, Y- and Z-axis
Result	Test passed

### Shocks

Specification	DIN EN 50155 (VDE 0115-200):2008-03
Pulse shape	Half-sine
Acceleration	5g
Shock duration	30 ms
Number of shocks per direction	3
Test directions	X-, Y- and Z-axis (pos. and neg.)
Result	Test passed

### Ambient conditions

Ambient temperature (operation)	-60 °C ... 105 °C (max. short-term operating temperature RTI Elec.)
Ambient temperature (storage/transport)	-25 °C ... 60 °C (for a short time, not exceeding 24 h, -60 °C to +70 °C)
Ambient temperature (assembly)	-5 °C ... 70 °C
Ambient temperature (actuation)	-5 °C ... 70 °C
Permissible humidity (storage/transport)	30 % ... 70 %

## Standards and regulations

Connection in acc. with standard	IEC 60947-7-1
----------------------------------	---------------

## Mounting

# UT 35 IB BU - Feed-through terminal block



3047730

<https://www.phoenixcontact.com/us/products/3047730>

Mounting type	NS 35/7,5
	NS 35/15

# UT 35 IB BU - Feed-through terminal block

3047730

<https://www.phoenixcontact.com/us/products/3047730>

## Drawings

Schematic diagram

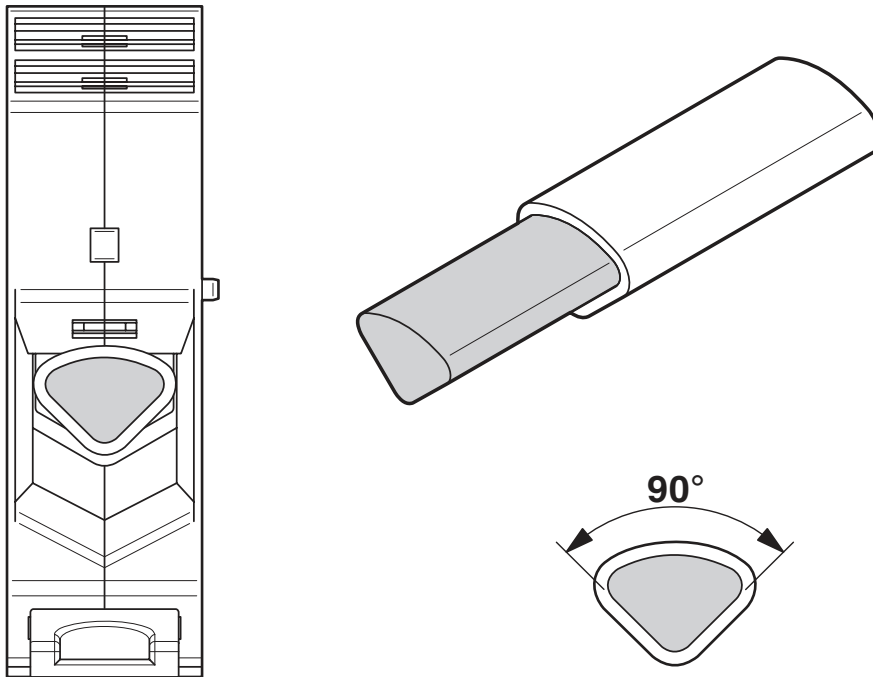

Connecting aluminum cables. Further notes can be found in the download area

Circuit diagram



# UT 35 IB BU - Feed-through terminal block





3047730

<https://www.phoenixcontact.com/us/products/3047730>

## Approvals

To download certificates, visit the product detail page: <https://www.phoenixcontact.com/us/products/3047730>

 <b>CSA</b> Approval ID: 13631				
	Nominal voltage $U_N$	Nominal current $I_N$	Cross section AWG	Cross section $\text{mm}^2$
Use group B	600 V	150 A	14 - 1/0	-

 <b>cULus Recognized</b> Approval ID: E60425				
	Nominal voltage $U_N$	Nominal current $I_N$	Cross section AWG	Cross section $\text{mm}^2$
Use group B	600 V	150 A	14 - 1/0	-
Use group C	600 V	150 A	14 - 1/0	-
Use group E	1000 V	150 A	14 - 1/0	-

 <b>ATEX</b> Approval ID: KEMA04ATEX2048U				
---	--	--	--	--

 <b>cUL Recognized</b> Approval ID: E192998				
	Nominal voltage $U_N$	Nominal current $I_N$	Cross section AWG	Cross section $\text{mm}^2$
	600 V	150 A	14 - 1/0	14

 <b>EAC Ex</b> Approval ID: RU C-DE.HA91.B.00066				
--	--	--	--	--

 <b>IECEX</b> Approval ID: IECEX KEM 06.0027U				
---	--	--	--	--

 <b>UL Recognized</b> Approval ID: E192998				
	Nominal voltage $U_N$	Nominal current $I_N$	Cross section AWG	Cross section $\text{mm}^2$
	600 V	150 A	14 - 1/0	-



# UT 35 IB BU - Feed-through terminal block



3047730

<https://www.phoenixcontact.com/us/products/3047730>



**CCC**

Approval ID: 2020322313000622



**UKCA-EX**

Approval ID: DEKRA 21UKEX0304U

**cULus Recognized**

# UT 35 IB BU - Feed-through terminal block



3047730

<https://www.phoenixcontact.com/us/products/3047730>

## Classifications

### ECLASS

ECLASS-11.0	27141120
ECLASS-13.0	27250101

### ETIM

ETIM 8.0	EC000897
----------	----------

### UNSPSC

UNSPSC 21.0	39121400
-------------	----------

# UT 35 IB BU - Feed-through terminal block



3047730

<https://www.phoenixcontact.com/us/products/3047730>

## Environmental product compliance

China RoHS	Environmentally friendly use period: unlimited = EFUP-e
	No hazardous substances above threshold values

# UT 35 IB BU - Feed-through terminal block

3047730

<https://www.phoenixcontact.com/us/products/3047730>

## Accessories

 Note: Applying some accessories below might limit this product.

### FBS 2-16 - Plug-in bridge

3005963

<https://www.phoenixcontact.com/us/products/3005963>



Plug-in bridge, pitch: 16 mm, number of positions: 2, length: 44 mm, color: red

 Max. current carrying capacity: 101 A

---

### RB UT 35-10 - Reducing bridge

3032168

<https://www.phoenixcontact.com/us/products/3032168>



Reducing bridge, pitch: 13.2 mm, number of positions: 2, color: red

 Max. current carrying capacity: 57 A

# UT 35 IB BU - Feed-through terminal block

3047730

<https://www.phoenixcontact.com/us/products/3047730>



## RB 35-16 - Reducing bridge

3032169

<https://www.phoenixcontact.com/us/products/3032169>



Reducing bridge, pitch: 14 mm, number of positions: 2, color: red

 Max. current carrying capacity: 90 A

---

## RB UT 35-(2,5/4) - Reducing bridge

3047277

<https://www.phoenixcontact.com/us/products/3047277>



Reducing bridge, pitch: 11 mm, number of positions: 2, color: red

 Max. current carrying capacity: 40 A

# UT 35 IB BU - Feed-through terminal block

3047730

<https://www.phoenixcontact.com/us/products/3047730>



## RB UT 35-ST(2,5/4) - Reducing bridge

3047280

<https://www.phoenixcontact.com/us/products/3047280>



Reducing bridge, pitch: 10.8 mm, number of positions: 2, color: red

 Max. current carrying capacity: 40 A

---

## AGK 4-UT 35 - Pick-off terminal

3047138

<https://www.phoenixcontact.com/us/products/3047138>



Pick-off terminal, nom. voltage: 1000 V, nominal current: 32 A, number of connections: 1, connection method: Screw connection, cross section: 0.14 mm<sup>2</sup> - 6 mm<sup>2</sup>, mounting type: on base element, color: gray

## UT 35 IB BU - Feed-through terminal block

3047730

<https://www.phoenixcontact.com/us/products/3047730>



## X-PEN 0,35 - Marker pen

0811228

<https://www.phoenixcontact.com/us/products/0811228>



Marker pen without ink cartridge, for manual labeling of markers, labeling extremely wipe-proof, line thickness 0.35 mm

---

## TPNS-UK - Partition plate

0706647

<https://www.phoenixcontact.com/us/products/0706647>



Partition plate, length: 80 mm, width: 2 mm, height: 80 mm, color: gray

# UT 35 IB BU - Feed-through terminal block

3047730

<https://www.phoenixcontact.com/us/products/3047730>



## WS UT 35 - Warning label

3047387

<https://www.phoenixcontact.com/us/products/3047387>

Warning sign for UT terminal blocks



---

## E/NS 35 N - End clamp

0800886

<https://www.phoenixcontact.com/us/products/0800886>

End clamp, width: 9.5 mm, color: gray





# UT 35 IB BU - Feed-through terminal block

3047730

<https://www.phoenixcontact.com/us/products/3047730>



## SF-THEX 4-150 - Screwdriver

1212640

<https://www.phoenixcontact.com/us/products/1212640>



T-handle screwdriver, for Allen screws, hexagonal (with chamfer), size: hex 4 x 150 mm, ergonomically shaped handle, matt chrome-plated

---

## SZS 1,0X6,5 VDE - Screwdriver

1205079

<https://www.phoenixcontact.com/us/products/1205079>



Screwdriver, slot-headed, VDE insulated, size: 1.0 x 6.5 x 150 mm, 2-component grip, with non-slip grip

# UT 35 IB BU - Feed-through terminal block

3047730

<https://www.phoenixcontact.com/us/products/3047730>



## NS 35/ 7,5 PERF 2000MM - DIN rail perforated

0801733

<https://www.phoenixcontact.com/us/products/0801733>



DIN rail perforated, acc. to EN 60715, material: Steel, galvanized, passivated with a thick layer, Standard profile, color: silver, Pack of 25 (50 m)

---

## NS 35/ 7,5 UNPERF 2000MM - DIN rail, unperforated

0801681

<https://www.phoenixcontact.com/us/products/0801681>



DIN rail, unperforated, acc. to EN 60715, material: Steel, galvanized, passivated with a thick layer, Standard profile, color: silver, Pack of 25 (50 m)

# UT 35 IB BU - Feed-through terminal block

3047730

<https://www.phoenixcontact.com/us/products/3047730>



## NS 35/ 7,5 WH PERF 2000MM - DIN rail perforated

1204119

<https://www.phoenixcontact.com/us/products/1204119>



DIN rail perforated, acc. to EN 60715, material: Steel, Galvanized, white passivated, Standard profile, color: silver, Pack of 25 (50 m)

---

## NS 35/ 7,5 WH UNPERF 2000MM-VPE 10 - DIN rail, unperforated

1204122

<https://www.phoenixcontact.com/us/products/1204122>



DIN rail, unperforated, acc. to EN 60715, material: Steel, Galvanized, white passivated, Standard profile, color: silver, Pack of 10 (20 m)

# UT 35 IB BU - Feed-through terminal block

3047730

<https://www.phoenixcontact.com/us/products/3047730>



## NS 35/ 7,5 AL UNPERF 2000MM - DIN rail, unperforated

0801704

<https://www.phoenixcontact.com/us/products/0801704>



DIN rail, unperforated, acc. to EN 60715, material: Aluminum, uncoated, Standard profile, color: silver, Pack of 25 (50 m)

---

## NS 35/ 7,5 ZN PERF 2000MM - DIN rail perforated

1206421

<https://www.phoenixcontact.com/us/products/1206421>



DIN rail perforated, acc. to EN 60715, material: Steel, galvanized, Standard profile, color: silver, Pack of 25 (50 m)

# UT 35 IB BU - Feed-through terminal block

3047730

<https://www.phoenixcontact.com/us/products/3047730>



## NS 35/ 7,5 ZN UNPERF 2000MM - DIN rail, unperforated

1206434

<https://www.phoenixcontact.com/us/products/1206434>



DIN rail, unperforated, acc. to EN 60715, material: Steel, galvanized, Standard profile, color: silver, Pack of 25 (50 m)

---

## NS 35/ 7,5 CU UNPERF 2000MM-VPE 10 - DIN rail, unperforated

0801762

<https://www.phoenixcontact.com/us/products/0801762>



DIN rail, unperforated, acc. to EN 60715, material: Copper, uncoated, Standard profile, color: copper-colored, Pack of 10 (20 m)

# UT 35 IB BU - Feed-through terminal block

3047730

<https://www.phoenixcontact.com/us/products/3047730>



## NS 35/ 7,5 CAP - End cap

1206560

<https://www.phoenixcontact.com/us/products/1206560>

DIN rail end piece, for DIN rail NS 35/7.5



---

## NS 35/15 PERF 2000MM - DIN rail perforated

1201730

<https://www.phoenixcontact.com/us/products/1201730>



DIN rail perforated, similar to EN 60715, material: Steel, galvanized, passivated with a thick layer, Standard profile, color: silver, Pack of 25 (50 m)

# UT 35 IB BU - Feed-through terminal block

3047730

<https://www.phoenixcontact.com/us/products/3047730>



## NS 35/15 UNPERF 2000MM - DIN rail, unperforated

1201714

<https://www.phoenixcontact.com/us/products/1201714>



DIN rail, unperforated, similar to EN 60715, material: Steel, galvanized, passivated with a thick layer, Standard profile, color: silver, Pack of 25 (50 m)

---

## NS 35/15 WH PERF 2000MM - DIN rail perforated

0806602

<https://www.phoenixcontact.com/us/products/0806602>



DIN rail perforated, similar to EN 60715, material: Steel, Galvanized, white passivated, Standard profile, color: white, Pack of 25 (50 m)

# UT 35 IB BU - Feed-through terminal block

3047730

<https://www.phoenixcontact.com/us/products/3047730>



## NS 35/15 WH UNPERF 2000MM-VPE 10 - DIN rail, unperforated

1204135

<https://www.phoenixcontact.com/us/products/1204135>



DIN rail, unperforated, similar to EN 60715, material: Steel, Galvanized, white passivated, Standard profile, color: silver, Pack of 10 (20 m)

---

## NS 35/15 AL UNPERF 2000MM - DIN rail, unperforated

1201756

<https://www.phoenixcontact.com/us/products/1201756>



DIN rail, unperforated, similar to EN 60715, material: Aluminum, uncoated, Standard profile, color: silver



# UT 35 IB BU - Feed-through terminal block

3047730

<https://www.phoenixcontact.com/us/products/3047730>



## NS 35/15 ZN PERF 2000MM - DIN rail perforated

1206599

<https://www.phoenixcontact.com/us/products/1206599>



DIN rail perforated, similar to EN 60715, material: Steel, galvanized, Standard profile, color: silver, Pack of 25 (50 m)

---

## NS 35/15 ZN UNPERF 2000MM - DIN rail, unperforated

1206586

<https://www.phoenixcontact.com/us/products/1206586>



DIN rail, unperforated, similar to EN 60715, material: Steel, galvanized, Standard profile, color: silver, Pack of 25 (50 m)

# UT 35 IB BU - Feed-through terminal block

3047730

<https://www.phoenixcontact.com/us/products/3047730>



## NS 35/15 CU UNPERF 2000MM-VPE 10 - DIN rail, unperforated

1201895

<https://www.phoenixcontact.com/us/products/1201895>



DIN rail, unperforated, similar to EN 60715, material: Copper, uncoated, Standard profile, color: copper-colored, Pack of 10 (20 m)

---

## NS 35/15 CAP - End cap

1206573

<https://www.phoenixcontact.com/us/products/1206573>

DIN rail end piece, for DIN rail NS 35/15



# UT 35 IB BU - Feed-through terminal block

3047730

<https://www.phoenixcontact.com/us/products/3047730>



## NS 35/15-2,3 UNPERF 2000MM-VPE 10 - DIN rail, unperforated

1201798

<https://www.phoenixcontact.com/us/products/1201798>



DIN rail, unperforated, acc. to EN 60715, material: Steel, galvanized, passivated with a thick layer, Standard profile 2.3 mm, color: silver, Pack of 10 (20 m)

---

## ZB 16:UNPRINTED - Zack marker strip

0827461

<https://www.phoenixcontact.com/us/products/0827461>



Zack marker strip, Strip, white, unlabeled, can be labeled with: PLOTMARK, CMS-P1-PLOTTER, mounting type: snapped, for terminal block width: 16 mm, lettering field size: 16 x 10.5 mm, Number of individual labels: 50

# UT 35 IB BU - Feed-through terminal block

3047730

<https://www.phoenixcontact.com/us/products/3047730>



## ZB 16 CUS - Zack marker strip

0827463

<https://www.phoenixcontact.com/us/products/0827463>



Zack marker strip, can be ordered: Strip, white, labeled according to customer specifications, mounting type: snap into tall marker groove, for terminal block width: 16 mm, lettering field size: 10.5 x 16 mm, Number of individual labels: 5

---

## ZB 16,LGS:L1-N,PE - Zack marker strip

0827462

<https://www.phoenixcontact.com/us/products/0827462>



Zack marker strip, Strip, white, labeled, printed horizontally: L1, L2, L3, N, PE, mounting type: snapped, for terminal block width: 16.3 mm, lettering field size: 10.5 x 16.25 mm, Number of individual labels: 5

# UT 35 IB BU - Feed-through terminal block

3047730

<https://www.phoenixcontact.com/us/products/3047730>



## UC-TM 16 - Marker for terminal blocks

0819217

<https://www.phoenixcontact.com/us/products/0819217>



Marker for terminal blocks, Sheet, white, unlabeled, can be labeled with: BLUEMARK ID COLOR, BLUEMARK ID, BLUEMARK CLED, PLOTMARK, CMS-P1-PLOTTER, mounting type: snapped, for terminal block width: 16 mm, lettering field size: 15.45 x 10.5 mm, Number of individual labels: 32

---

## UC-TM 16 CUS - Marker for terminal blocks

0824621

<https://www.phoenixcontact.com/us/products/0824621>



Marker for terminal blocks, can be ordered: by sheet, white, labeled according to customer specifications, mounting type: snap into tall marker groove, for terminal block width: 16 mm, lettering field size: 15.45 x 10.5 mm, Number of individual labels: 32

# UT 35 IB BU - Feed-through terminal block



3047730

<https://www.phoenixcontact.com/us/products/3047730>

## UCT-TM 16 - Marker for terminal blocks

0829146

<https://www.phoenixcontact.com/us/products/0829146>



Marker for terminal blocks, Sheet, white, unlabeled, can be labeled with: TOPMARK NEO, TOPMARK LASER, BLUEMARK ID COLOR, BLUEMARK ID, BLUEMARK CLED, THERMOMARK PRIME, THERMOMARK CARD 2.0, THERMOMARK CARD, mounting type: snapped, for terminal block width: 16 mm, lettering field size: 14.8 x 9.6 mm, Number of individual labels: 18

---

## UCT-TM 16 CUS - Marker for terminal blocks

0829637

<https://www.phoenixcontact.com/us/products/0829637>



Marker for terminal blocks, can be ordered: by sheet, white, labeled according to customer specifications, mounting type: snap into tall marker groove, for terminal block width: 16 mm, lettering field size: 14.8 x 9.6 mm, Number of individual labels: 18

## UT 35 IB BU - Feed-through terminal block

3047730

<https://www.phoenixcontact.com/us/products/3047730>



## PROJECT COMPLETE - Software

1050453

<https://www.phoenixcontact.com/us/products/1050453>



Intuitive planning and marking software for configuring terminal strips and for professional marking of marking materials for terminal blocks, conductors, cables, devices, and systems. The software is available for download

---

## E/UK - End clamp

1201442

<https://www.phoenixcontact.com/us/products/1201442>



End clamp, material: PA, color: gray, Mounting on a DIN rail NS 32 or NS 35

# UT 35 IB BU - Feed-through terminal block

3047730

<https://www.phoenixcontact.com/us/products/3047730>



## E/UK 1 - End clamp

1201413

<https://www.phoenixcontact.com/us/products/1201413>



End clamps, for supporting the ends of double-level and three-level terminal blocks, width: 10 mm, color: gray

---

## CLIPFIX 35 - End clamp

3022218

<https://www.phoenixcontact.com/us/products/3022218>



Quick mounting end clamp for NS 35/7,5 DIN rail or NS 35/15 DIN rail, with marking option, width: 9.5 mm, color: gray



# UT 35 IB BU - Feed-through terminal block

3047730

<https://www.phoenixcontact.com/us/products/3047730>



## CLIPFIX 35-5 - End clamp

3022276

<https://www.phoenixcontact.com/us/products/3022276>



Quick mounting end clamp for NS 35/7,5 DIN rail or NS 35/15 DIN rail, with marking option, with parking option for FBS...5, FBS...6, KSS 5, KSS 6, width: 5.15 mm, color: gray

---

Phoenix Contact 2023 © - all rights reserved

<https://www.phoenixcontact.com>

Phoenix Contact USA  
586 Fulling Mill Road  
Middletown, PA 17057, United States  
(+717) 944-1300  
[info@phoenixcon.com](mailto:info@phoenixcon.com)