

1500 – 2700 MHz High Linearity LNA

Device Features

- Internally matched to 50 ohms
- Operated at 3.0V and 5.0V
- 36.2 dBm Output IP3 at 0dBm/tone at 1850 MHz
- 18.5dB Gain at 1850MHz
- 19.6dBm P1dB at 1850MHz
- 0.65 dB NF at 1850MHz on evaluation board
- Green/RoHS2 Compliant DFN8 2x2 Package

Product Description

BeRex's BLB02 is a high linearity LNA, based on GaAs material with E-pHEMT process and packaged in a RoHS2-compliant DFN 8L 2x2mm² Surface mount package. It is designed for use where low noise and high linearity are required and features low noise and high OIP3 at Frequency range of 1.5~2.7GHz. It is internally matched to 50 Ohms without external matching components, with fast enable switching speed for TD-LTE application. All devices are 100% RF/DC tested and classified as HBM ESD Class 1B.

Applications

- Base station Infrastructure/RFID
- Commercial/Industrial/Military wireless system
- TDD or FDD LTE systems

Applications Circuit

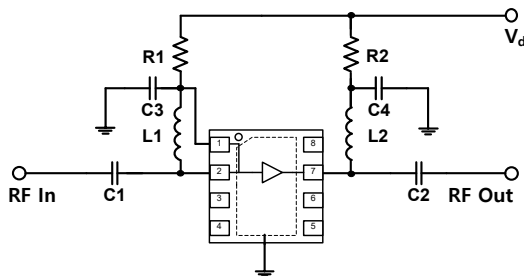

* Refer to [page 14](#) for Enable application.

BOM	5V Value	3V Value	Size	Vendor
C1,C2,C4	100pF	100pF	0603	Samsung
C3	12pF	12pF	0603	Samsung
R1	6.8Kohm	5.1Kohm	0603	Samsung
R2	3 ohm	3 ohm	0603	Samsung
L1	15nH	15nH	0603	Taiyo Yuden
L2	39nH	39nH	0603	Taiyo Yuden

Part Marking (XX:Wafer number)



Electrical Specifications

Device performance _ measured on a BeRex evaluation board at 25°C, Vd=5V, 50 Ω system.

Parameter	Conditions	Min	Typ	Max	Unit
Operational Frequency Range		1500		2700	MHz
Test Frequency			1850		MHz
Gain		17.0	18.5		dB
Input Return Loss			-11.5		dB
Output Return Loss			-15.5		dB
Output IP3	0 dBm / tone , Δf=1 MHz	33.2	36.2		dBm
Output P1dB		18.6	19.6		dBm
Noise Figure			0.65	0.85	dB

* N.F : Losses on input and output transmission lines on PCB are not de-embedded.

Device performance _ measured on a BeRex evaluation board at 25°C, Vd=3V, 50 Ω system.

Parameter	Conditions	Min	Typ	Max	Unit
Operational Frequency Range		1500		2700	MHz
Test Frequency			1850		MHz
Gain		16.6	18.1		dB
Input Return Loss			-10.4		dB
Output Return Loss			-14.8		dB
Output IP3	0 dBm / tone , Δf=1 MHz	27.2	30.2		dBm
Output P1dB		14.6	15.6		dBm
Noise Figure			0.55	0.75	dB

* N.F : Losses on input and output transmission lines on PCB are not de-embedded.

Recommended Operating Conditions

Parameter	Min	Typ	Max	Unit
Bandwidth	1500		2700	MHz
I _d @ (V _d = 5.0V)	48	60	72	mA
I _d @ (V _d = 3.0V)	28	35	42	mA
V _d	3	5	5.25	V
dG/dT		-0.008		dB/°C
R _{TH}		34.1		°C/W
Operating Case Temperature	-40		+105	°C
Switching Time(T _{on})		250		ns
Switching Time(T _{off})		140		ns

Electrical specifications are measured at specified test conditions.

Specifications are not guaranteed over all recommended operating conditions.

1500 – 2700 MHz High Linearity LNA

Absolute Maximum Ratings

Parameter	Rating	Unit
Storage Temperature	-55 to +155	°C
Junction Temperature	+160	°C
Supply Voltage	+6	V
Supply Current	130	mA
Input RF Power	21	dBm

Operation of this device above any of these parameters may result in permanent damage.

Typical Performance (V_d=5.0V, I_d=60mA, T=25°C)

Parameter	Frequency					Unit
V _d = 5V	1750	1850	1950	2140	2650	MHz
Gain	19.0	18.5	18.1	17.5	15.6	dB
S11	-12.0	-11.5	-11.8	-11.9	-13.4	dB
S22	-14.5	-15.5	-13.2	-12.0	-10.4	dB
OIP3	36.0	36.2	36.8	35.0	33.0	dBm
P1dB	19.5	19.6	19.5	19.2	19.0	dBm
Noise Figure	0.60	0.65	0.67	0.77	0.99	dB

* NF : Losses on input and output transmission lines on PCB are not de-embedded.

Typical Performance (V_d=3.0V, I_d=35mA, T=25°C)

Parameter	Frequency					Unit
V _d = 3V	1750	1850	1950	2140	2650	MHz
Gain	18.4	18.1	17.7	17.0	15.2	dB
S11	-10.7	-10.4	-10.6	-10.7	-12.1	dB
S22	-14.6	-14.8	-12.5	-11.5	-10.2	dB
OIP3	30.2	30.2	30	28.7	28.2	dBm
P1dB	15.4	15.6	15.8	15.6	15.7	dBm
Noise Figure	0.53	0.55	0.56	0.65	0.89	dB

* NF : Losses on input and output transmission lines on PCB are not de-embedded.

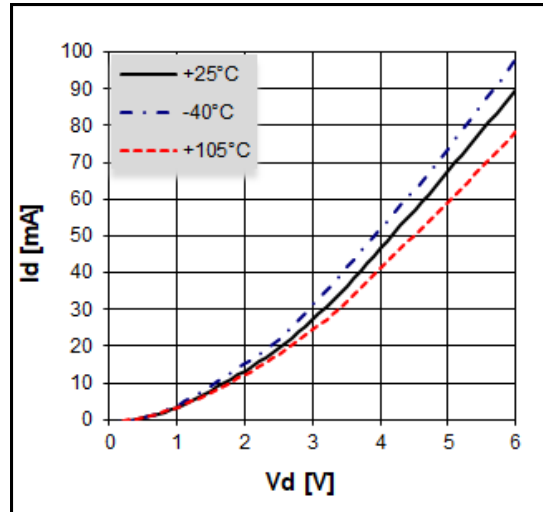
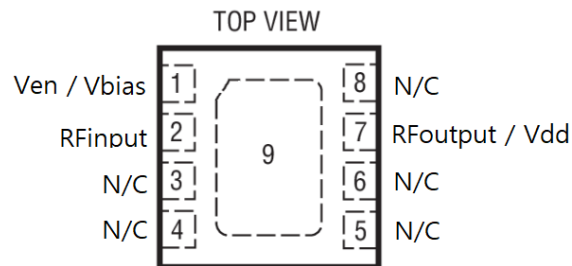
1500 – 2700 MHz High Linearity LNA
V-I Characteristics

Pin Configuration

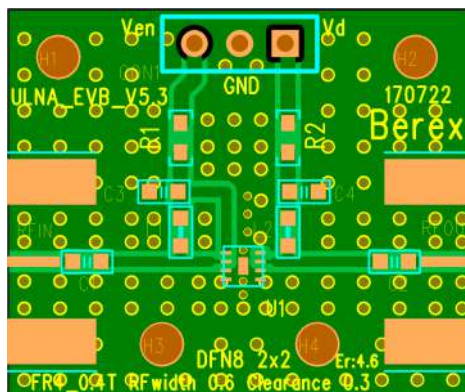
DC PACKAGE
 8-LEAD (2mm × 2mm) PLASTIC DFN
 EXPOSED PAD (PIN 9) IS GND, MUST BE SOLDERED TO PCB

Evaluation Board

*Dielectric constant _ 4.2 *RF pattern width 24mil *16mil thick FR4 PCB

1500 – 2700 MHz High Linearity LNA

Typical Device Data

S-parameters ($V_d=5.0V$, $I_d=60mA$, $T=25^\circ C$)

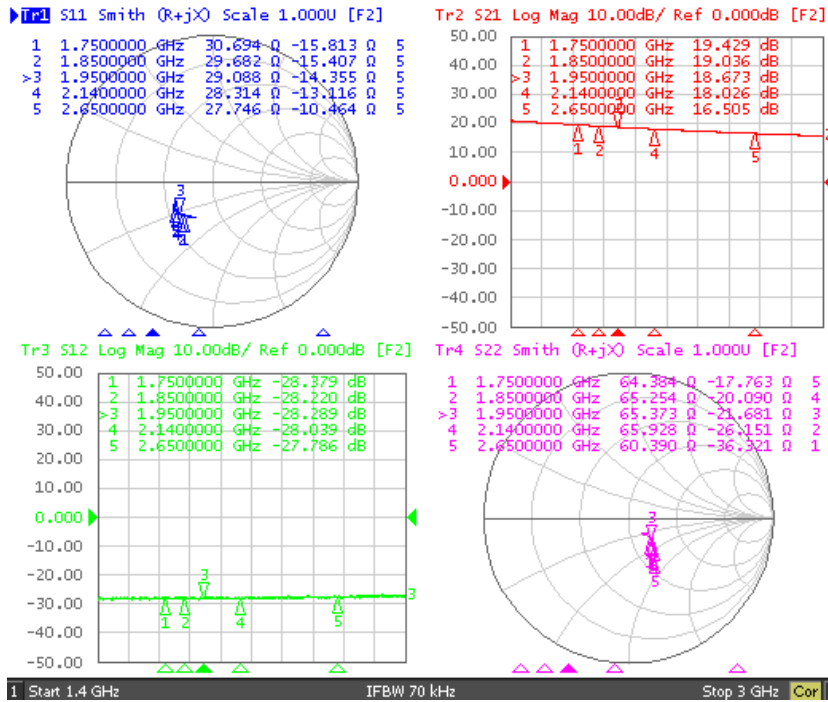

S-parameters ($V_d=3.0V$, $I_d=35mA$, $T=25^\circ C$)

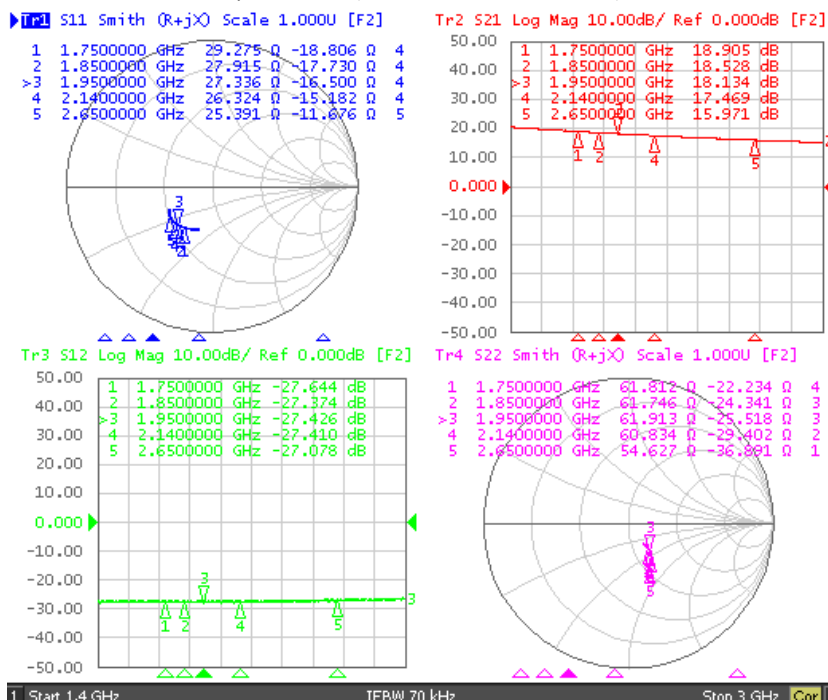

1500 – 2700 MHz High Linearity LNA
S-Parameter

(Vd=5.0V, Id = 60mA, T = 25 °C, calibrated to device leads)

Freq [MHz]	S11 Mag	S11 Ang	S21 Mag	S21 Ang	S12 Mag	S12 Ang	S22 Mag	S22 Ang
1500	0.29	-119.63	10.57	105.01	0.04	17.18	0.16	-44.07
1600	0.29	-123.76	10.04	100.48	0.04	15.79	0.17	-42.35
1700	0.30	-128.32	9.60	96.15	0.04	15.23	0.19	-42.07
1800	0.31	-131.07	9.16	92.14	0.04	11.77	0.20	-42.98
1900	0.31	-133.63	8.76	88.42	0.04	12.84	0.22	-42.96
2000	0.32	-136.12	8.39	84.45	0.04	10.54	0.24	-44.48
2100	0.32	-138.60	8.10	80.94	0.04	10.29	0.25	-44.72
2200	0.32	-141.00	7.78	77.36	0.04	7.74	0.27	-46.99
2300	0.32	-142.98	7.51	73.78	0.04	7.92	0.28	-48.66
2400	0.32	-143.70	7.25	70.67	0.04	4.95	0.30	-51.24
2500	0.32	-145.08	7.01	67.44	0.04	4.46	0.31	-52.75
2600	0.31	-146.89	6.77	64.26	0.04	4.88	0.32	-54.76
2700	0.31	-148.06	6.59	60.91	0.04	0.18	0.33	-56.90

(Vd=3.0V, Id = 35mA, T = 25 °C, calibrated to device leads)

Freq [MHz]	S11 Mag	S11 Ang	S21 Mag	S21 Ang	S12 Mag	S12 Ang	S22 Mag	S22 Ang
1500	0.33	-113.72	9.96	105.42	0.04	14.98	0.19	-52.50
1600	0.33	-118.36	9.46	100.83	0.04	14.16	0.20	-51.51
1700	0.34	-123.13	9.04	96.32	0.04	12.20	0.22	-50.82
1800	0.35	-126.39	8.62	92.19	0.04	11.30	0.23	-51.55
1900	0.35	-129.92	8.24	88.28	0.04	11.53	0.24	-51.73
2000	0.36	-132.85	7.91	84.09	0.04	10.00	0.26	-53.05
2100	0.36	-135.64	7.59	80.64	0.04	7.89	0.27	-53.85
2200	0.36	-138.37	7.31	77.00	0.04	7.22	0.28	-55.71
2300	0.36	-140.12	7.05	73.62	0.04	5.52	0.30	-56.83
2400	0.36	-142.07	6.81	69.96	0.04	6.08	0.31	-58.83
2500	0.36	-144.20	6.58	66.76	0.04	5.69	0.32	-60.85
2600	0.35	-146.16	6.35	63.60	0.04	3.61	0.33	-62.55
2700	0.35	-147.22	6.18	60.21	0.05	1.62	0.34	-64.95

1500 – 2700 MHz High Linearity LNA

Typical Performance

Vd=5.0V, Id=60mA , T=25°C

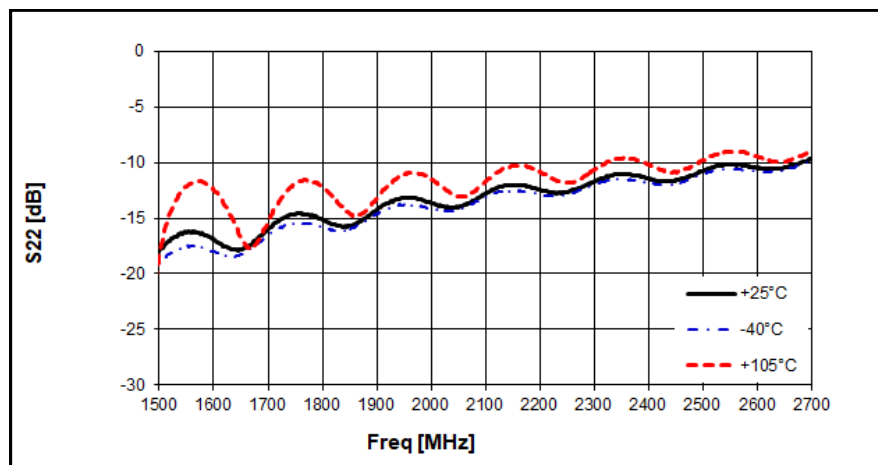
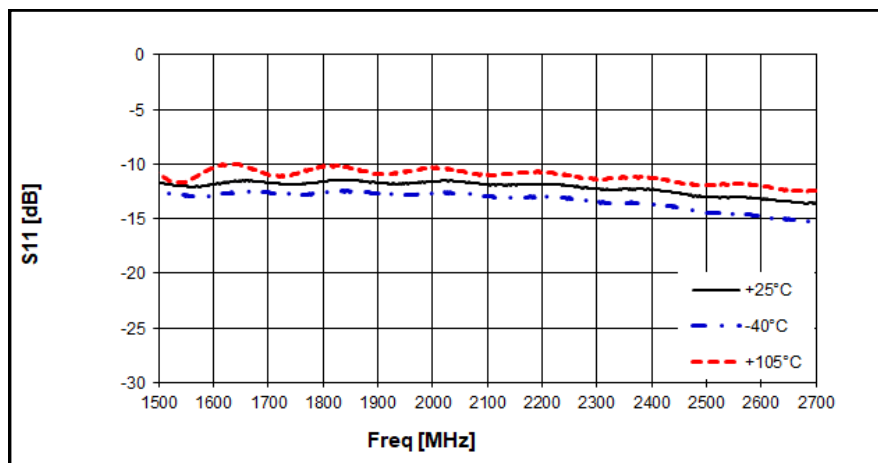
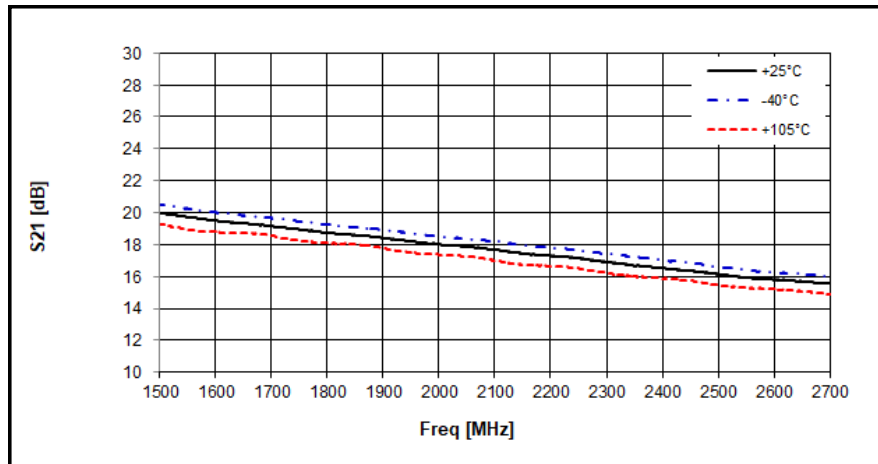

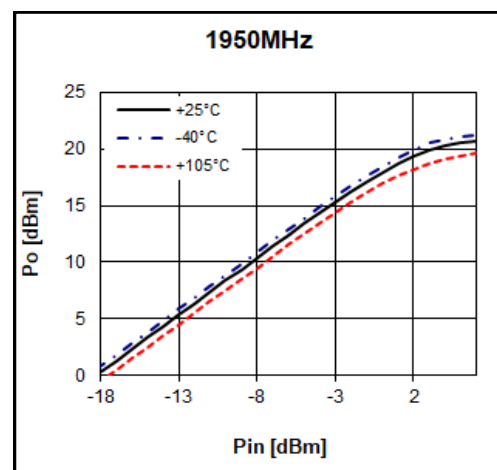
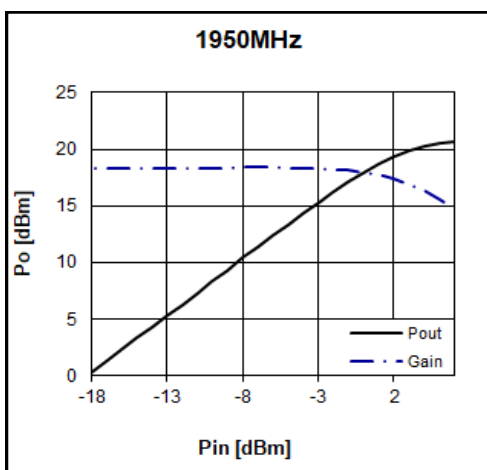
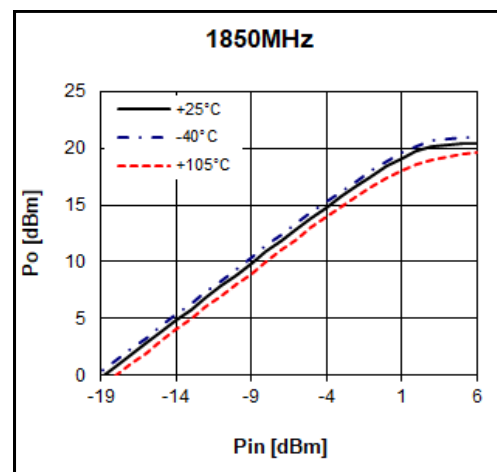
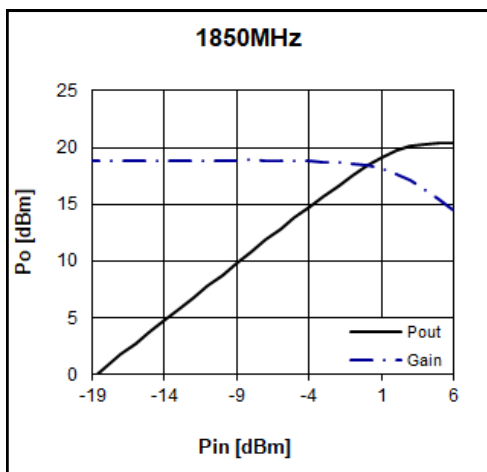
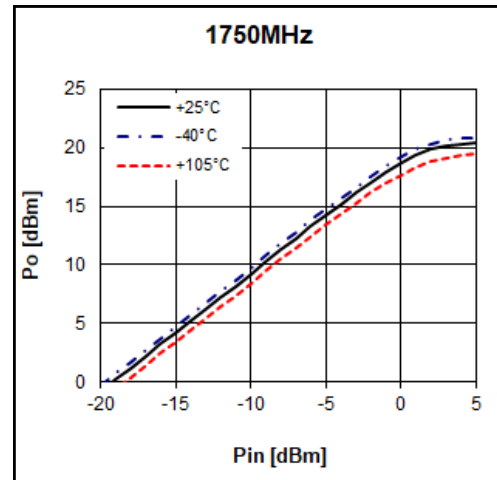
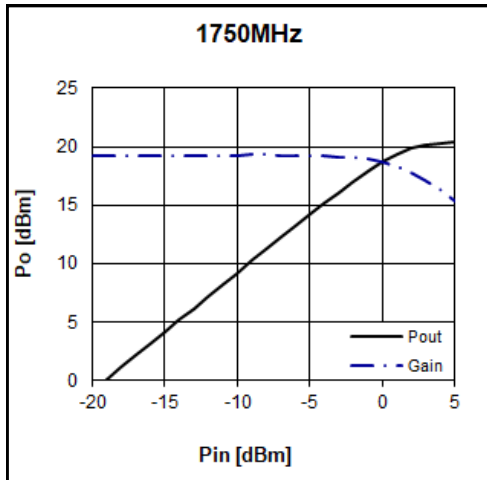
1500 – 2700 MHz High Linearity LNA

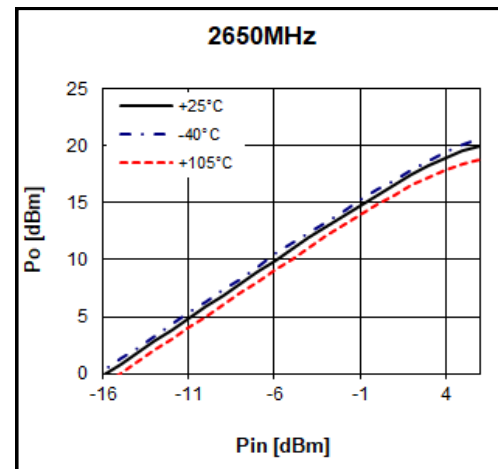
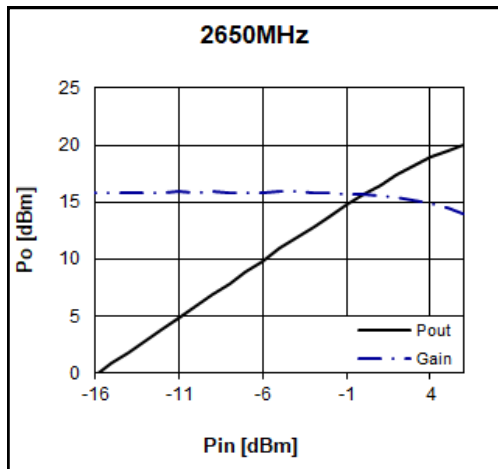
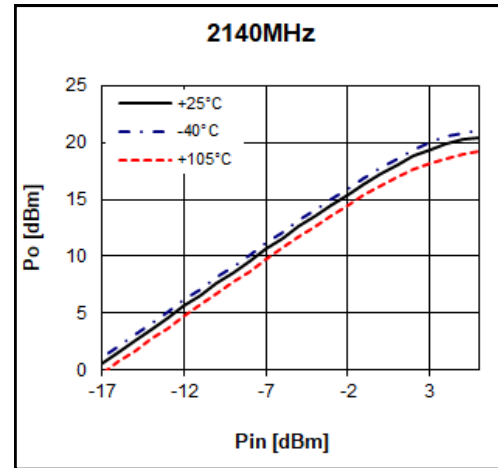
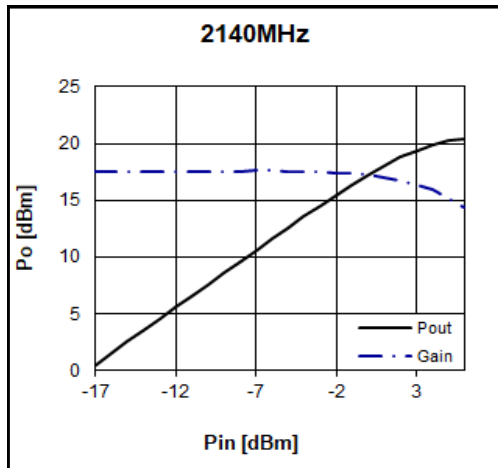
1500 – 2700 MHz High Linearity LNA

Noise Figure Temperature Performance

(Vds = 5.0V, Ids = 60mA)

Freq	MHz	1750	1850	1950	2140	2650
Temp [°C]	-40	0.57	0.60	0.62	0.72	0.92
	+25	0.60	0.65	0.67	0.77	0.99
	+105	0.76	0.78	0.86	0.96	1.19

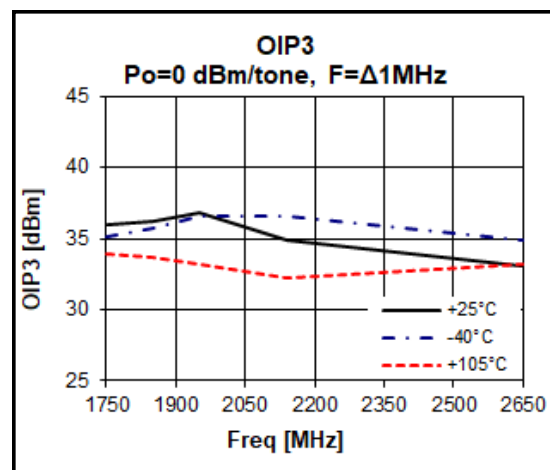
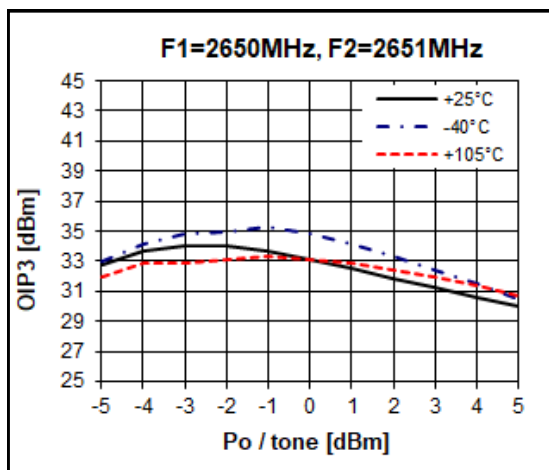
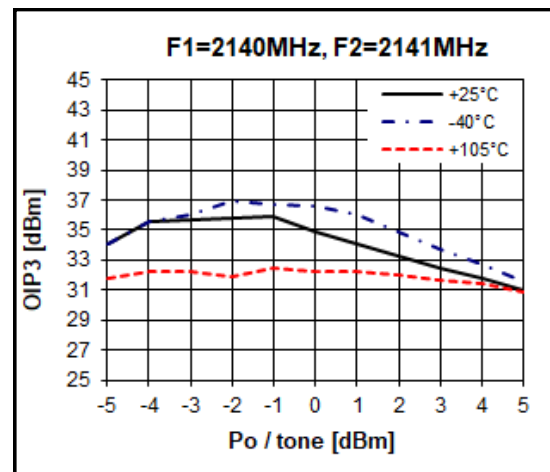
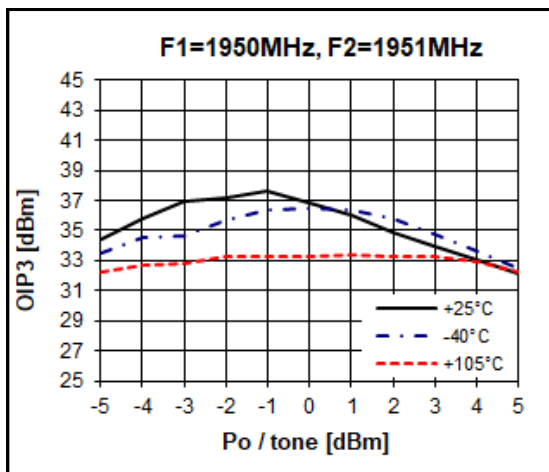
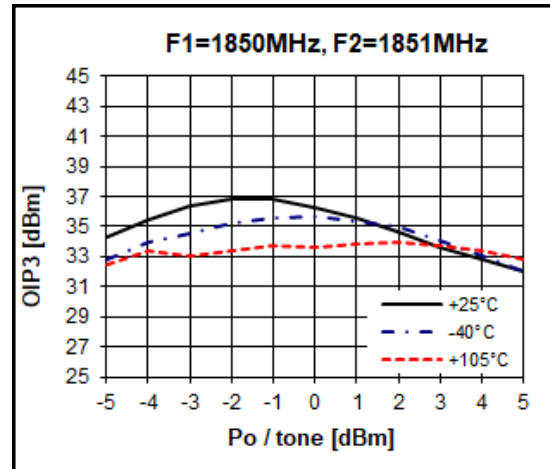
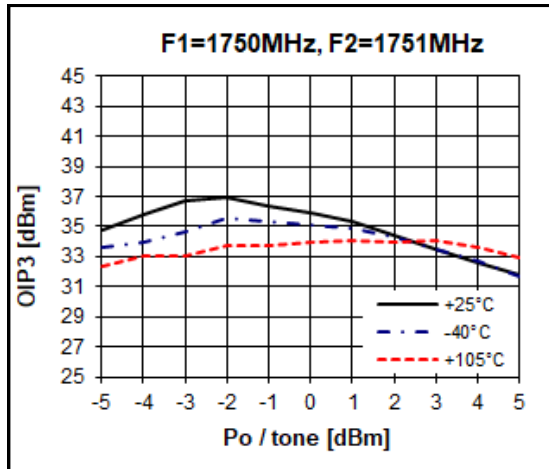
* NF : Losses on input and output transmission lines on PCB are not de-embedded.

1500 – 2700 MHz High Linearity LNA

1500 – 2700 MHz High Linearity LNA

Typical Performance

Vd=3.0V, Id=35mA , T=25°C

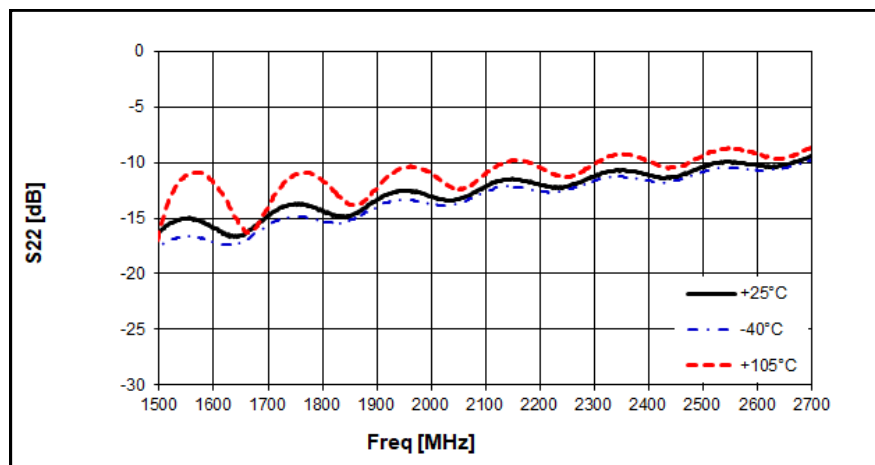
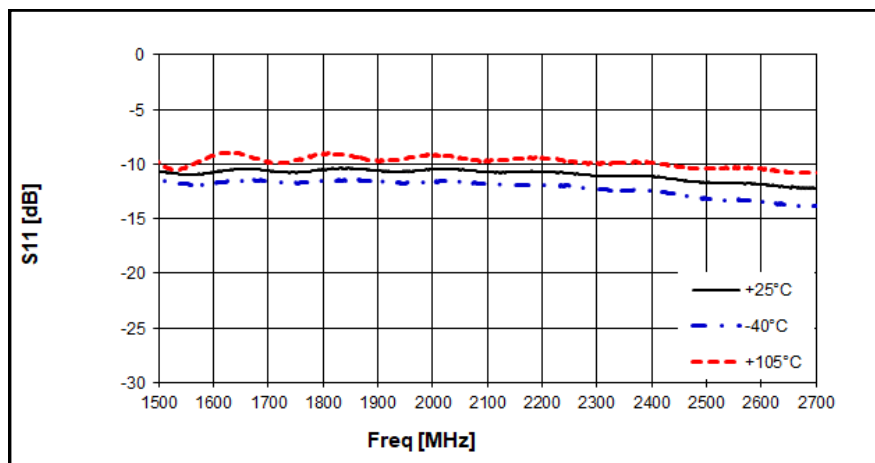
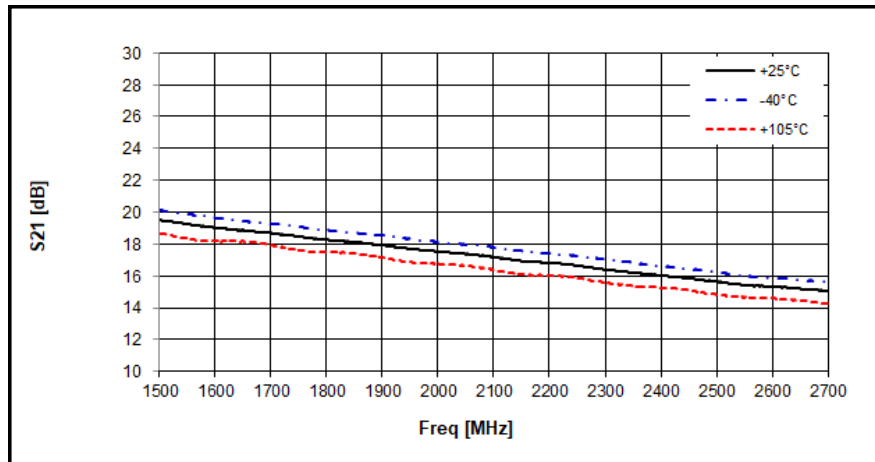

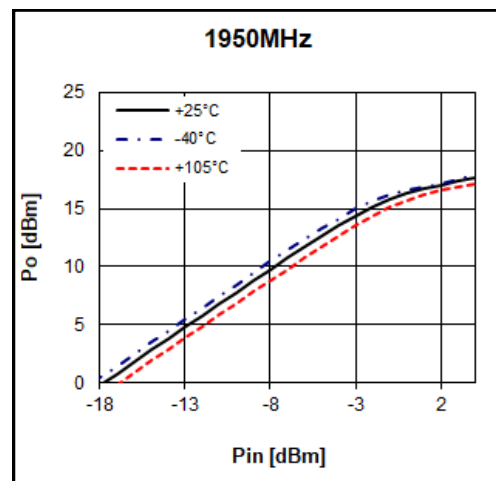
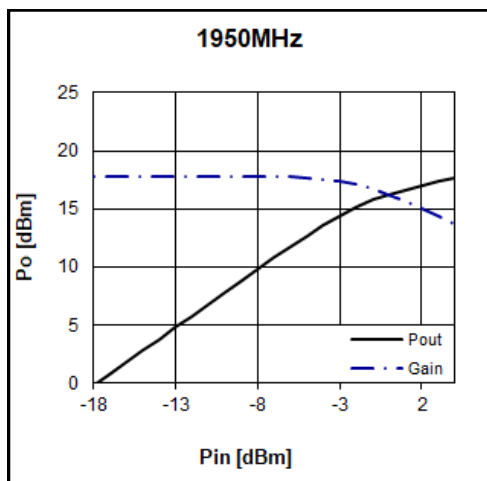
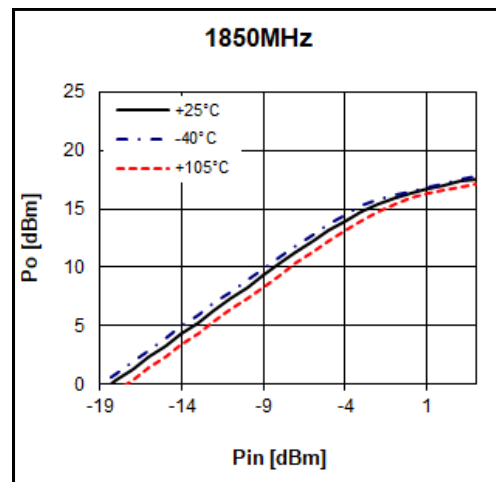
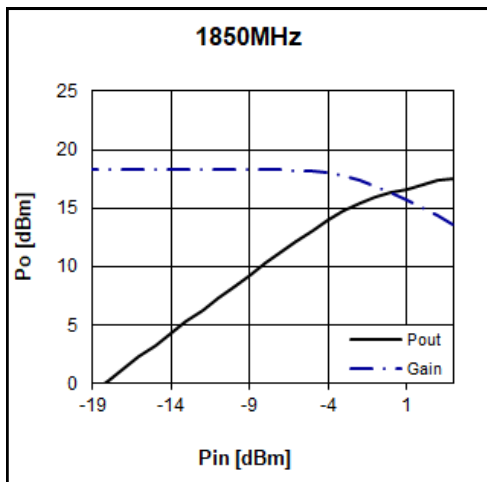
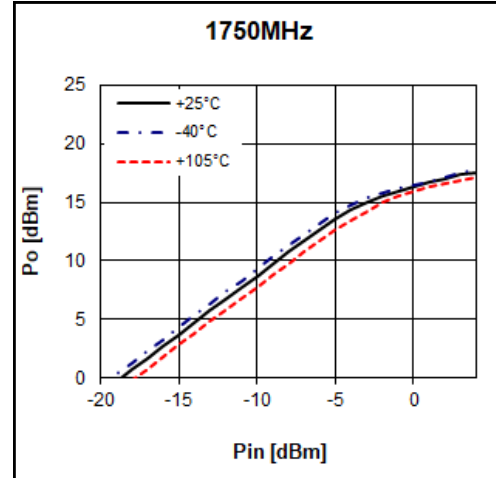
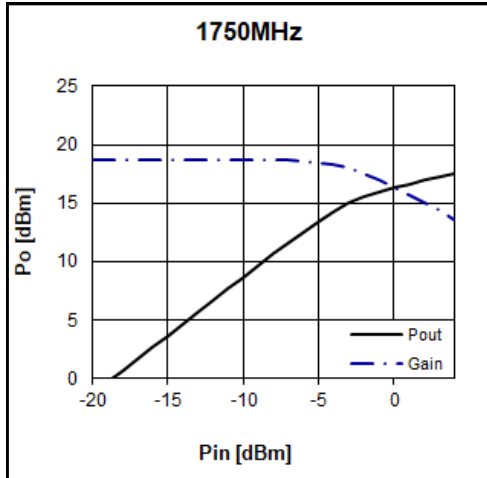
1500 – 2700 MHz High Linearity LNA

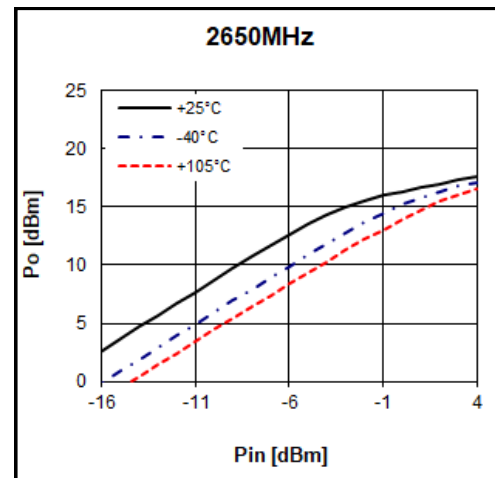
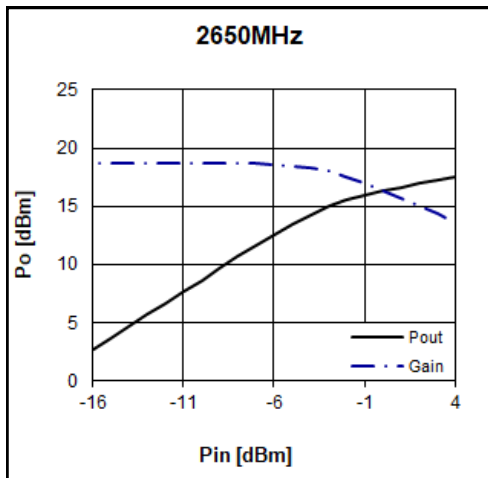
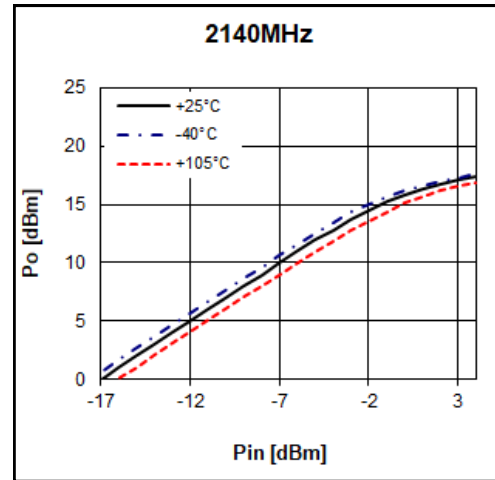
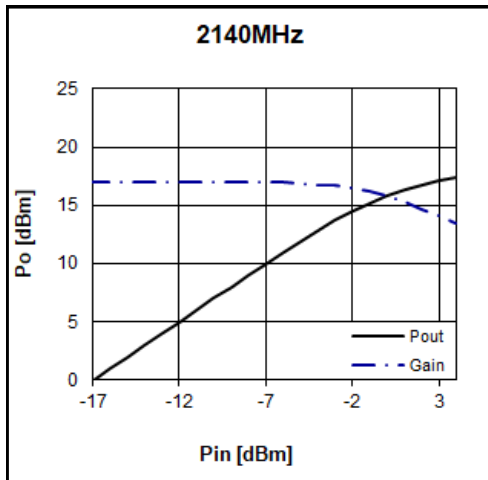
1500 – 2700 MHz High Linearity LNA

Noise Figure Temperature Performance

(Vds = 3.0V, Ids = 35mA)

Freq	MHz	1750	1850	1950	2140	2650
Temp [°C]	-40	0.46	0.49	0.50	0.58	0.79
	+25	0.53	0.55	0.56	0.65	0.89
	+105	0.62	0.70	0.72	0.86	1.09

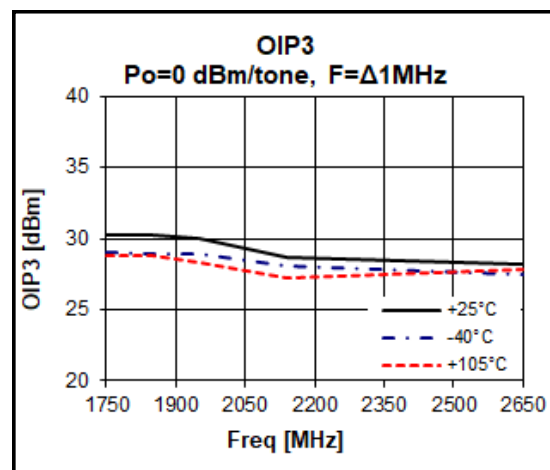
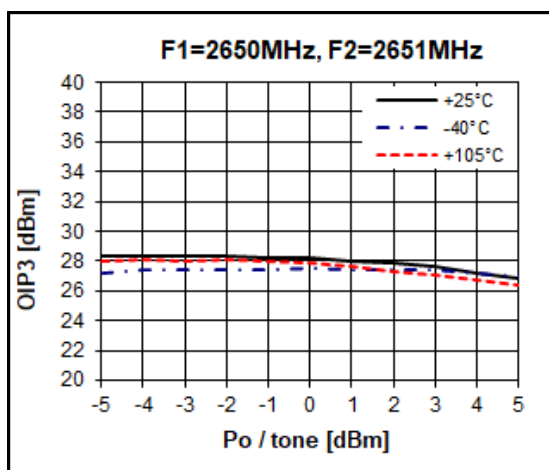
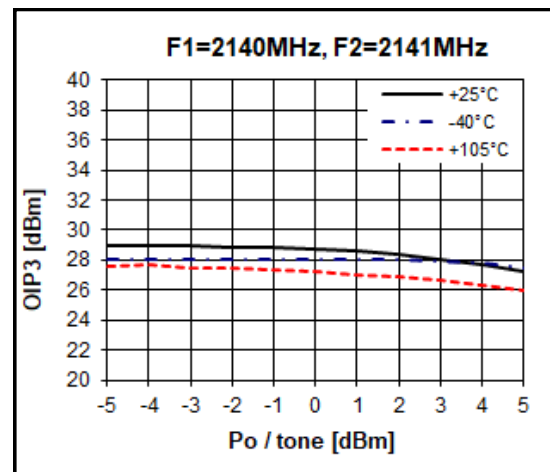
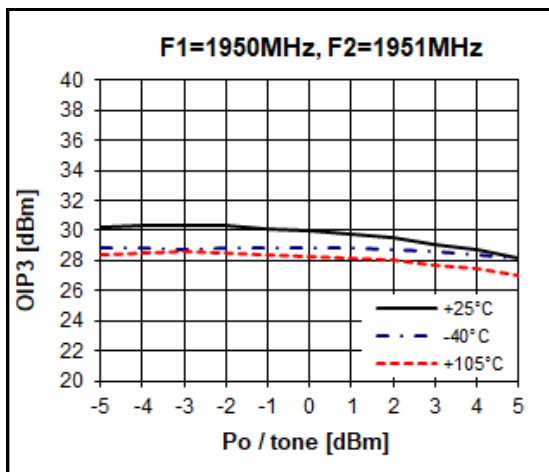
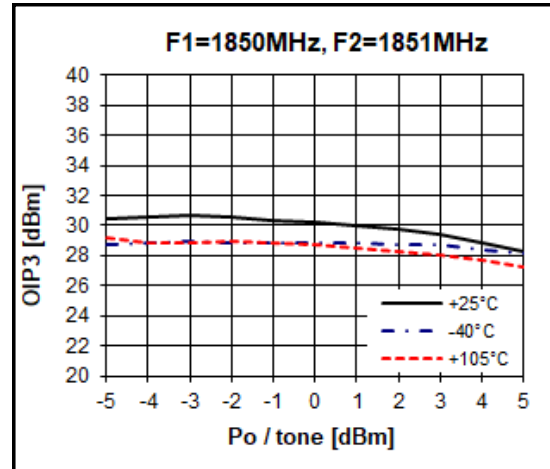
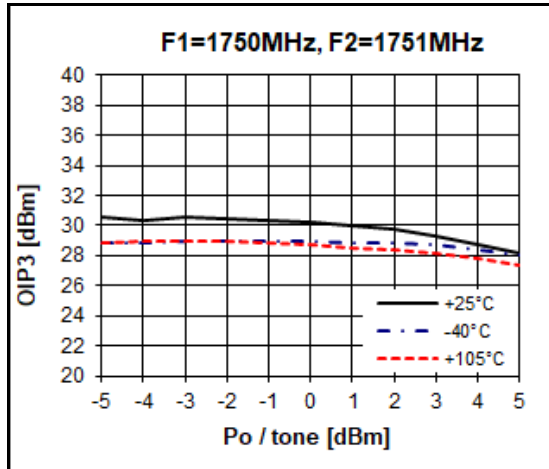
* NF : Losses on input and output transmission lines on PCB are not de-embedded.

1500 – 2700 MHz High Linearity LNA

Enable Application

State function

V _d	V _{en}	State
5V	0V	Off
5V	5V	On

Switching Time

	Min.	Typical	Max.	Unit
Raising Time(T _{on})		250		ns
Falling Time(T _{off})		140		ns

Application circuit

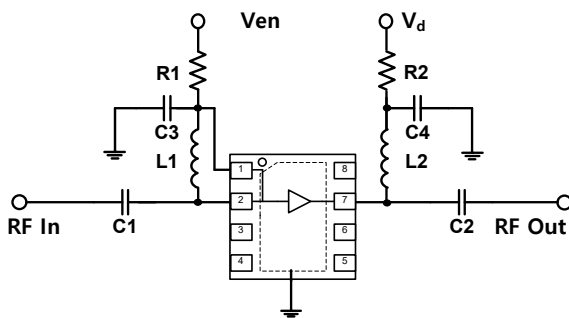

BOM

Component	Value	Size	Vendor
C1,C2,C4	100pF	0603	Samsung
C3	12pF	0603	Samsung
R1	6.8Kohm	0603	Samsung
R2	3 ohm	0603	Samsung
L1	15nH	0603	Taiyo Yuden
L2	39nH	0603	Taiyo Yuden

Package Outline Dimension

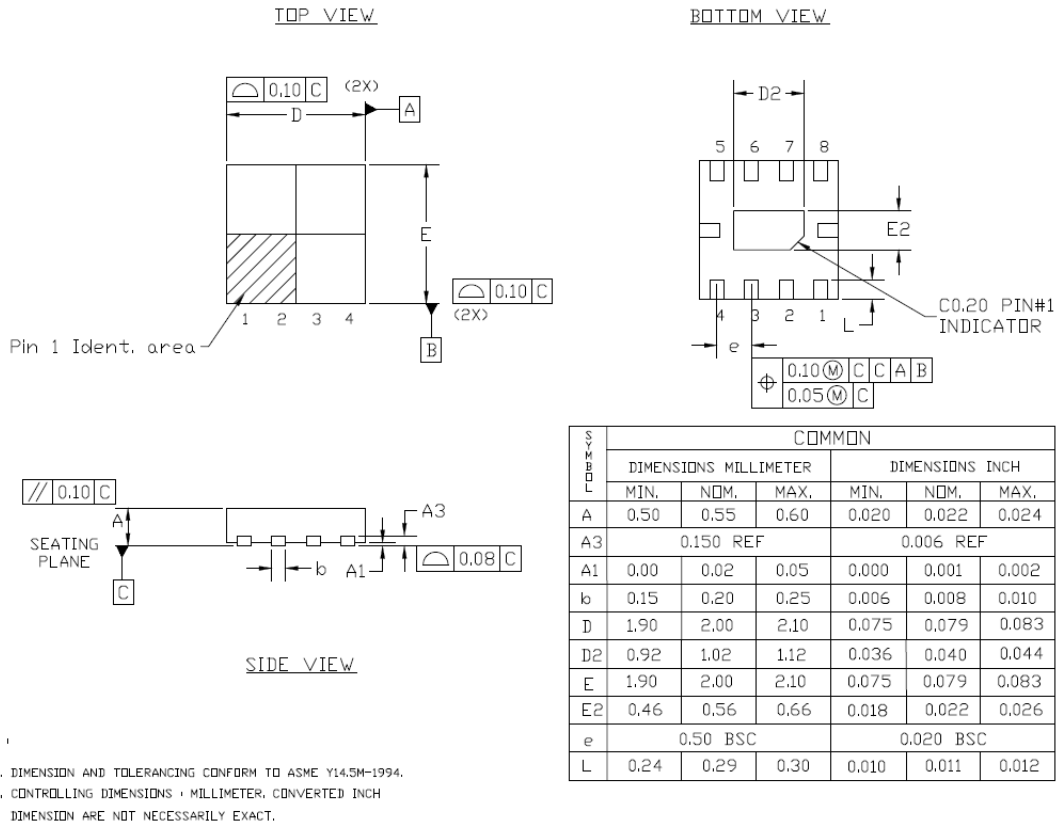

Suggested PCB Land Pattern and PAD Layout

PCB Land Pattern

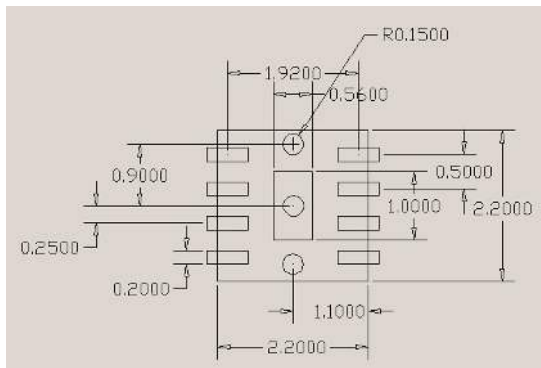

Note : All dimension _ millimeters

PCB lay out _ on BeRex website

PCB Mounting

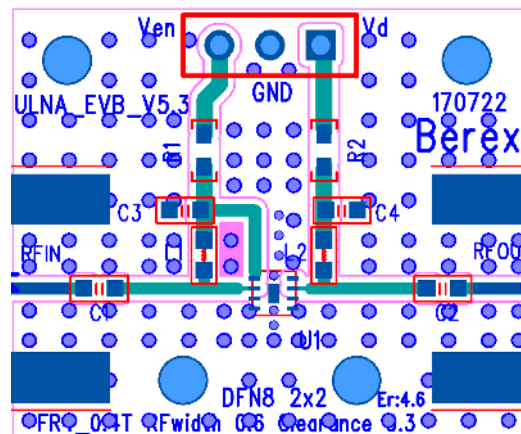

1500 – 2700 MHz High Linearity LNA

Package Marking

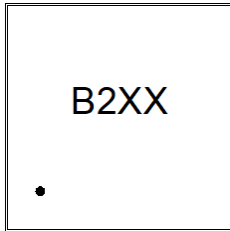

Pin 1

XX = Wafer No.

Tape & Reel

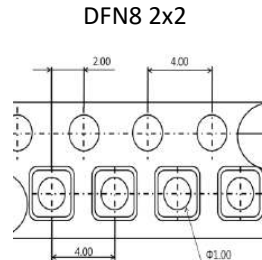

Packaging information:

Tape Width (mm): 8

Reel Size (inches): 7

Device Cavity Pitch (mm): 4

Devices Per Reel: 3000

Lead plating finish

100% Tin Matte finish

(All BeRex products undergoes a 1 hour, 150 degree C, Anneal bake to eliminate thin whisker growth concerns.)

MSL / ESD Rating

ESD Rating: Class 1B
Value: Passes <1000V
Test: Human Body Model (HBM)
Standard: JEDEC Standard JS-001-2014

MSL Rating: Level 1 at +260°C convection reflow
Standard: JEDEC Standard J-STD-020



Proper ESD procedures should be followed when handling this device.

1500 – 2700 MHz High Linearity LNA

RoHS Compliance

This part is compliant with Restrictions on the Use of Certain Hazardous Substances in Electrical and Electronic Equipment (RoHS) Directive 2011/65/EU as amended by Directive 2015/863/EU.

This product also is compliant with a concentration of the Substances of Very High Concern (SVHC) candidate list which are contained in a quantity of less than 0.1%(w/w) in each components of a product and/or its packaging placed on the European Community market by the BeRex and Suppliers.

NATO CAGE code:

2	N	9	6	F
---	---	---	---	---