

SPECIFICATIONS

(RoHS Compliant)



Model Number: SDD48B1-E3
Part Number: 17001218A

Version: 00
Jun 13, 2018

Mechanical Drawing:

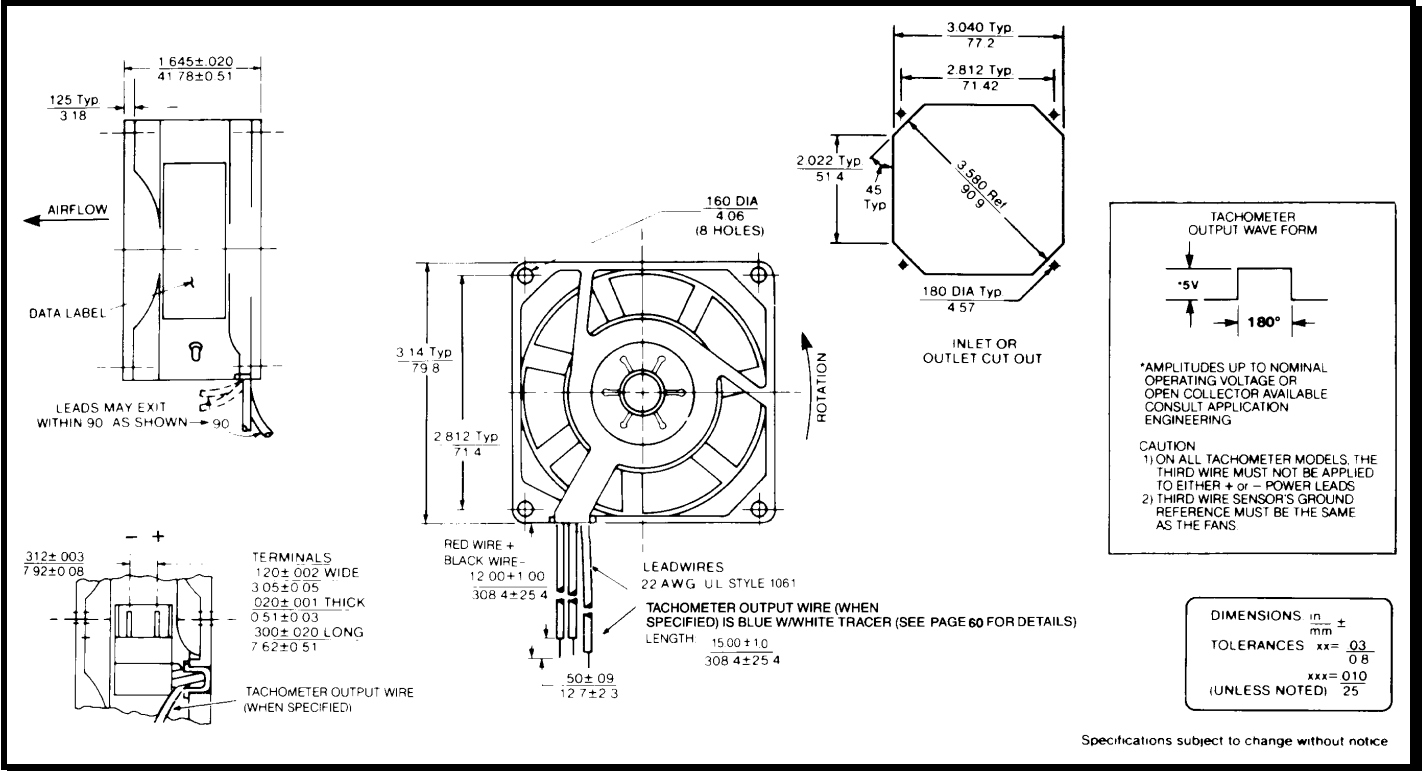

Motor:

Nominal Voltage	= 48 vdc
Operating Voltage Range	= 36 – 60vdc
Nominal Running Current	= 0.06 amps
Locked Rotor Current	= 0.6 amps
Running Power	= 3.0 watts
Average Speed	= 3500
Bearings	= Ball
Air Flow	= 35 CFM
Acoustic	= 47.6 dBA

Construction:

Venturi: Single Piece Die-Cast Zinc Alloy, Black
 Propeller: Plastic, Black, UL 94V-0

Life Expectancy:

This fan is designed for continuous duty life of 52,000 hours at 70°C.

Additional Features:

- Brushless DC Motor
- Polarity Protected
- Electronic Locked Rotor Protection
- Automatic Restart Capability
- Operating Temperature: -10°C to 70°C
- Storage Temperature: -40°C to 85°C
- Environmental Protection: Type 3(IP68)

Termination:

- 12" Lead wires, AWG 22, UL 1061
- Red = Power (+)
- Black = Return (-)

Agency Approvals:

UL, CUL, CE

PQ Curve:

