

# HRLV-ShortRange® - EZ™ Series

## High Resolution, Precision, Low Voltage Ultrasonic Range Finder

MB1603, MB1604, MB1613, MB1614, MB1623, MB1624, MB1633, MB1634, MB1643, & MB1644<sup>5</sup>



The HRLV-ShortRange-EZ sensor line is the most cost-effective solution for close range applications where precision range-finding, low-voltage operation, and low-cost are needed. This sensor component module allows users of other more costly precision rangefinders to lower the cost of their systems without sacrificing performance.

The HRLV-ShortRange-EZ sensor line provides high accuracy and high resolution ultrasonic proximity detection and ranging in air, in a package less than one cubic inch. This sensor line features 1-mm resolution, target-size and operating-voltage compensation for improved accuracy, superior rejection of outside noise sources, internal speed-of-sound temperature compensation and optional external speed-of-sound temperature compensation. This ultrasonic sensor detects large objects from 1-mm<sup>6</sup> to 5-meters, senses range to objects from 2-cm to 5-meters. The interface output formats are pulse width, analog voltage, and serial digital in RS232. Factory calibration is standard. <sup>1</sup>See Close Range Operation

### Precision Range Sensing

- Range-finding at a fraction of the cost of other precision rangefinders
- Reading-to-reading stability of 1-mm at 1-meter is typical
- Accuracy is factory-matched at 1-meter to 0.2% providing a typical large target accuracy of 1% +/-3-mm for most voltages and uses<sup>2</sup>
- Calibrated acoustic detection zones allows selection of the part number that matches a specific application
- Compensation for target size variation and operating voltage range
- Standard internal temperature compensation and optional external temperature compensation

### Range Outputs

- Pulse width, (1uS/mm)
- Analog Voltage, (5mm resolution)
- RS232 Serial, (at TTL voltage levels)
- TTL Serial

### Easy to Use Component Module

- Gracefully handles other ultrasonic sensors<sup>3</sup>
- Stable and reliable range readings and excellent noise rejection make the sensor easy to use

- Easy to use interface with distance provided in a variety of outputs
- Target size compensation provides greater consistency and accuracy when switching targets
- Sensor automatically handles acoustic noise<sup>2,3</sup>
- Sensor ignores other acoustic noise sources
- Small and easy to mount
- Calibrated sensor eliminates most sensor to sensor variations
- Very low power ranger, excellent for multiple sensors or battery based systems

### General Characteristics

- Low-cost ultrasonic rangefinder
- Size less than 1 cubic inch with easy mounting
- Object proximity detection from 1-mm to 5-meters
- Resolution of 1-mm
- Excellent Mean Time Between Failure (MTBF)
- Triggered operation yields a real-time
- 100mS measurement cycle
- Free run operation uses a 2Hz filter, with 100mS measurement and output cycle
- Actual operating temperature range from -40°C to +65°C, Recommended operating temperature range from -15°C to +65°C, provided proper frost prevention is employed<sup>4</sup>

- Operating voltage from 2.5V to 5.5V<sup>4</sup>
- Nominal current draw of 2.5mA at 3.3V, and 3.5mA at 5V
- Low current draw reduces current drain for battery operation
- Fast first reading after power-up eases battery requirements

### Notes:

- <sup>1</sup> See Close Range Operation
- <sup>2</sup> Users are encouraged to evaluate the sensor performance in their application.
- <sup>3</sup> See page 6 for multi-sensor operation.
- <sup>4</sup> Please reference page 5 for minimum operating voltage verses temperature information.
- <sup>5</sup> Please reference page 16 for part number key.
- <sup>6</sup> Small and/or angled targets may have limited detection at distances less than 2cm.

### Close Range Operation

Applications requiring 100% reading-to-reading reliability should not use MaxSonar sensors at a distance closer than 2cm. Although most users find MaxSonar sensors to work reliably from 0 to 2cm for detecting objects in many applications, MaxBotix® Inc. does not guarantee operational reliability for objects closer than the minimum reported distance. Because of ultrasonic physics, these sensors are unable to achieve 100% reliability at close distances.

### Warning: Personal Safety Applications

We do not recommend or endorse this product be used as a component in any personal safety applications. This product is not designed, intended or authorized for such use. These sensors and controls do not include the self-checking redundant circuitry needed for such use. Such unauthorized use may create a failure of the MaxBotix® Inc. product which may result in personal injury or death. MaxBotix® Inc. will not be held liable for unauthorized use of this component.

**Applications & Uses**

- Proximity zone detection
- People detection
- Robots ranging sensor
- Autonomous navigation distance measuring
- Long range object detection

- Automated factory systems
- This product is not recommended as a device for personal safety
- Designed for protected indoor environments
- Motion detectors
- Limited tank level measurements

- Box dimensions
- Environments with acoustic and electrical noise
- Height monitors
- Auto sizing

**Pin Out Description**

**Pin 1- Temperature Sensor Connection:** Leave this pin unconnected if an external temperature sensor is not used. For best accuracy, this pin is optionally connected to the HR-MaxTemp temperature sensor. Look up the HR-MaxTemp temperature sensor for additional information.

**Pin 2- Pulse Width Output:** This pin outputs a pulse width representation of the distance with a scale factor of 1uS per mm. Output range is 20uS for 20-mm to 5000uS for 5000-mm. Pulse width output is +/- 1% of the serial data sent.

**Pin 3- Analog Voltage Output:** On power-up the voltage on this pin,  $V_{\text{observed}}$ , is set to 0V. After which, the voltage on this pin has the voltage corresponding to the latest measured distance. This distance can be calculated with the following equation:  $\text{distance} = [V_{\text{observed}} / ((V_{\text{cc}}/1024) * 6)] - 300$ . (This output voltage is referenced to GND, Pin 7.) The analog voltage output is typically within ±10-mm of the serial output.

Using a 10bit analog to digital convertor, one can read the analog voltage bits (i.e. 0 to 1023) directly and multiply the number of bits in the value by 6 and subtract 300 to yield the range in mm. For example, 54 bits corresponds to 24-mm where  $(54 * 6) - 300 = 24$ -mm.

**Pin 4- Ranging Start/Stop:** This pin is internally pulled high. If this pin is left unconnected or held high, the sensor will continually measure and output the range data. If held low, the HRLV-ShortRange-EZ will stop ranging. Bring high for 20uS or longer to command a range reading.

**Real-time Range Data:** When pin 4 is low and then brought high, the sensor will operate in real time and the first reading output will be the range measured from this first commanded range reading. When the sensor tracks that the RX pin is low after each range reading, and then the RX pin is brought high, unfiltered real time range information can be obtained as quickly as every 100mS.

**Filtered Range Data:** When pin 4 is left high, the sensor will continue to range every 100mS, but the output will pass through a 2Hz filter, where the sensor will output the range based on recent range information.

**Pin 5-Serial Output:** By default, the serial output is RS232 format (0 to Vcc) with a 1-mm resolution. The output is an ASCII capital “R”, followed by four ASCII character digits representing the range in millimeters, followed by a carriage return (ASCII 13). The maximum distance reported is 5000. The serial output is the most accurate of the range outputs. Serial data sent is 9600 baud, with 8 data bits, no parity, and one stop bit. On power up the sensor will send serial data about the sensor. [View an example here.](#)

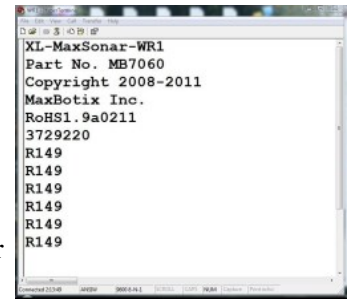

**V+ Pin 6 - Positive Power, Vcc:** The sensor operates on voltages from 2.5V - 5.5V DC. For best operation, the sensor requires that the DC power be free from electrical noise. (For installations with known dirty electrical power, a 100uF capacitor placed at the sensor pins between V+ and GND will typically correct the electrical noise.) Please reference page 5 for minimum operating voltage verses temperature information.

**GND Pin 7 – Sensor ground pin:** DC return, and circuit common ground.

**About Ultrasonic Sensors**

Our ultrasonic sensors are in air, non-contact object detection and ranging sensors that detect objects within an area. These sensors are not affected by the color or other visual characteristics of the detected object. Ultrasonic sensors use high frequency sound to detect and localize objects in a variety of environments. Ultrasonic sensors measure the time of flight for sound that has been transmitted to and reflected back from nearby objects. Based upon the time of flight, the sensor then outputs a range reading.

**Auto Calibration**

Each time the HRLV-ShortRange-EZ takes a range reading, it calibrates itself. The sensor uses this data to range objects. If the temperature, humidity, or applied voltage changes during sensor operation; the sensor will continue to function normally over the rated temperature range while applying compensation for changes caused by temperature and voltage.

### Sensor Operation: Free-Run

When operating in free run mode, most range readings are accurately reported. If the range readings are affected, the effect is typically less than 5 mm. This allows users to employ real-time ultrasonic distance sensing without the need for additional supporting circuitry or complicated user software.

Many acoustic noise sources will have little to no affect on the reported range of the HRLV-ShortRange-EZ sensors. However, users are encouraged to test sensor operation in the operating environment.

### Sensor Minimum Distance

The sensor minimum reported distance is 2-cm (0.8 inches). However, the HRLV-ShortRange-EZ will detect targets to within 1-mm of the front sensor face. Large targets closer than 2-cm will typically range as 20-mm.

### Sensor Operation from 2-cm to 50-cm

Because of acoustic phase effects in the near field, objects between 2-cm and 50-cm may experience acoustic phase cancellation of the returning waveform resulting in inaccuracies of up to 3-mm. These effects become less prevalent as the target distance increases, and has not been observed past 50-cm. For this reason, industrial users that require the highest sensor accuracy are encouraged to mount the HRLV-ShortRange-EZ from objects that are farther than 50-cm.

### Range “0” Location

The HRLV-ShortRange-EZ reports the range to distant targets starting from the front of the transducer.

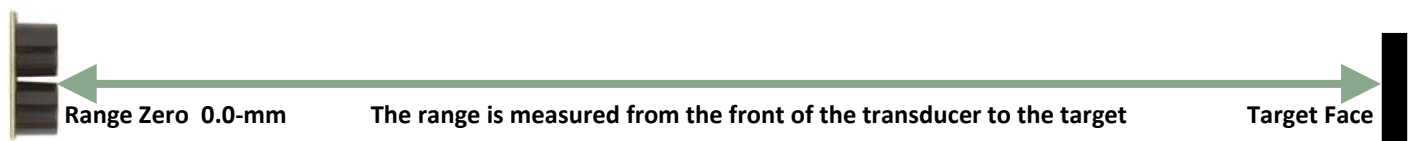

In general, the HRLV-ShortRange-EZ will report the range to the leading edge of the closest detectable object. Target detection has been characterized in the sensor beam patterns.

### Target Size Compensation

Most low cost ultrasonic rangefinders will report the range to smaller size targets as farther than the actual distance. In addition, they may also report the range to larger size targets as closer than the actual distance.

The HRLV-ShortRange-EZ sensor line correctly compensates for target size differences. Provided an object is large enough to be detected, the sensor will report the same distance, typically within 2%, regardless of target size. Smaller targets can have additional detection noise that may limit this feature. In addition, targets with small or rounded surfaces may have an apparent distance that is slightly farther, where the distance reported may be a composite of the sensed object(s). Compensation for target size is applied to all outputs: pulse width, analog voltage, and serial RS232 or TTL.

### Selecting a HRLV-ShortRange-EZ

The HRLV-ShortRange-EZ product line offers varied sensitivity to allow you to select the best sensor to meet your needs.

The diagram below shows how each product balances sensitivity and noise tolerance. This does not affect the maximum range, pin outputs, or other operations of the sensor. To view how each sensor will function to different sized targets reference the HRLV-ShortRange-EZ-Beam Patterns.

Part Number	Serial Interface	People Detection	Wide Beam	High Sensitivity	Best Balance	Large Targets	Narrow Beam	Noise Tolerance	5 Meter Range
MB1603	RS232	Yes	Yes	Yes					Yes
MB1613	RS232	Yes	Yes	Yes	Yes				Yes
MB1623	RS232				Yes				Yes
MB1633	RS232				Yes	Yes	Yes	Yes	Yes
MB1643	RS232					Yes	Yes	Yes	Yes
MB1604	TTL	Yes	Yes	Yes					Yes
MB1614	TTL	Yes	Yes	Yes	Yes				Yes
MB1624	TTL				Yes				Yes
MB1634	TTL				Yes	Yes	Yes	Yes	Yes
MB1644	TTL					Yes	Yes	Yes	Yes

## Supply Voltage Droop and Charge Compensation

During power up, the HRLV-ShortRange-EZ sensor line will calibrate itself for changes in supply voltage. Additionally, the sensor will compensate if the supplied voltage gradually changes.

If the voltage applied to the sensor changes faster than 0.5V per second, it is best to remove and reapply power.

The sensor requires noise free power for best operation. If the sensor is used with noise on the supplied power, the readings may be affected. Typically adding a 100uF capacitor at the sensor between the V+ and GND pins will correct most power related electrical noise issues.

## Mechanical Dimensions

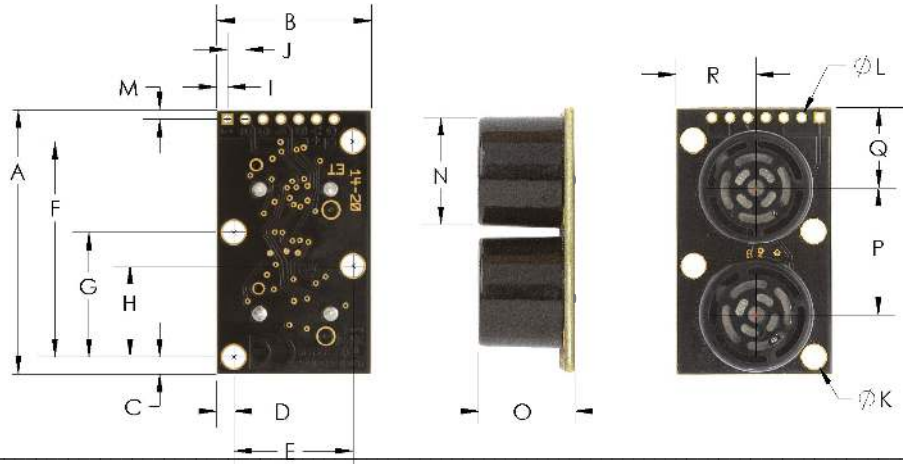

A	1.498"	38.05-mm	D	0.104"	2.64-mm	G	0.700"	17.78-mm	K	0.125 dia.	3.18-mm	K	0.125 dia.	3.18-mm	O	0.580"	13.97-mm
B	0.875"	22.23-mm	E	0.670"	17.02-mm	H	0.510"	12.95-mm	L	0.040" dia.	1.02-mm	L	0.040" dia.	1.02-mm	P	0.700"	17.78-mm
C	0.102"	2.59-mm	F	1.210"	30.73-mm	I	0.069"	1.75-mm	M	0.053"	1.35-mm	M	0.053"	1.35-mm	Q	0.343"	8.71-mm
Weight 8 Grams						J	0.169"	4.29-mm	N	0.625"	15.88-mm	N	0.625"	15.88-mm	R	0.427"	10.85-mm

## Temperature Compensation

### On Board - Internal Temperature Compensation

The speed of sound in air increases about 0.6 meters per second, per degree centigrade. Because of this, each HRLV-ShortRange-EZ is equipped with an internal temperature sensor which allows the sensor to apply a compensation for speed of sound changes.

The self heating (15mW at 5V, or 8mW at 3.3V) will change the temperature of the sensor by about 1 degree C. The amount of self heating is dependent upon user mounting.

Most importantly, the actual air temperature of the path between the sensor and the target may not match the temperature measured at the sensor electronics. Sensors mounted in vertical applications, or applications where the environmental temperature gradient is severe, may experience a large temperature measurement error which will affect the sensor accuracy. For example, buildings with a height of 2-meters can have floor to ceiling temperature variations of 5°C or more. Because of these temperature affects, users desiring the highest accuracy output are encouraged to use a properly mounted external temperature sensor or to manually account for this measurement error.

### HR-MaxTemp® External Temperature Sensor

Although the HRLV-ShortRange-EZ has an internal temperature sensor; for best accuracy users are encouraged to use the optional external temperature sensor. On power-up the HRLV-ShortRange-EZ will automatically detect an attached HR-MaxTemp temperature sensor and begin to apply temperature compensation using the external temperature sensor.

The external temperature sensor allows for the most accurate temperature compensation by eliminating sensor self-heating from the sensor electronics; and by allowing the user to place the temperature sensor closer to the center of the acoustic ranging path.

For best results connect the temperature sensor midway between the HRLV-ShortRange-EZ and the expected target.

**Voltage vs Temperature**

The graph below shows minimum operating voltage of the sensor verses temperature.

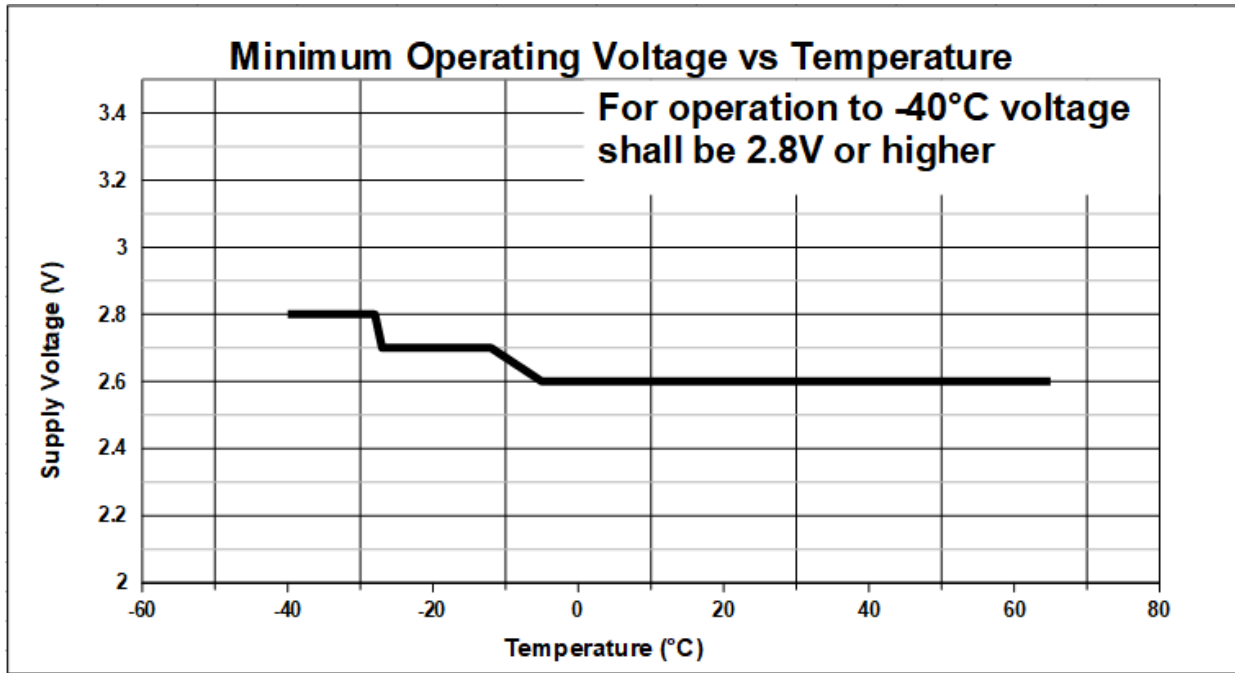

## Operating Modes

### Multiple Sensor Operation

Multiple HRLV-ShortRange-EZ sensors can be used simultaneously in the same environment generally with little to no interference (cross-talk). Even so, some cross-talk may still occur for users wishing to use a large number of sensors in the same environment. This interference is rare and can be up to +/- 1 cm of the target's distance. Because of this, sensor to sensor interference must be accounted for. To avoid interference between sensors, chaining can be used to prevent cross-talk between sensors. This will be necessary when using 3+ sensors depending on mounting and environment.

The recommended chaining method is AN Output Commanded Loop. The first sensor will range, then trigger the next sensor to range and so on for all the sensors in the array. Once the last sensor has ranged, the array stops until the first sensor is triggered to range again. Below is a diagram on how to set this up.

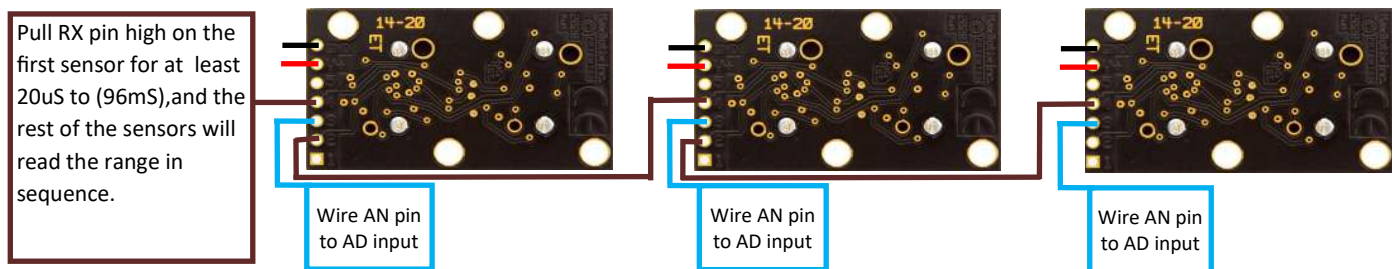

Another recommended chaining method is AN Output Constantly Looping. The first sensor will range, then trigger the next sensor to range and so on for all the sensors in the array. Once the last sensor has ranged, it will trigger the first sensor in the array to range again and will continue this loop indefinitely. Below is a diagram on how to set this up.

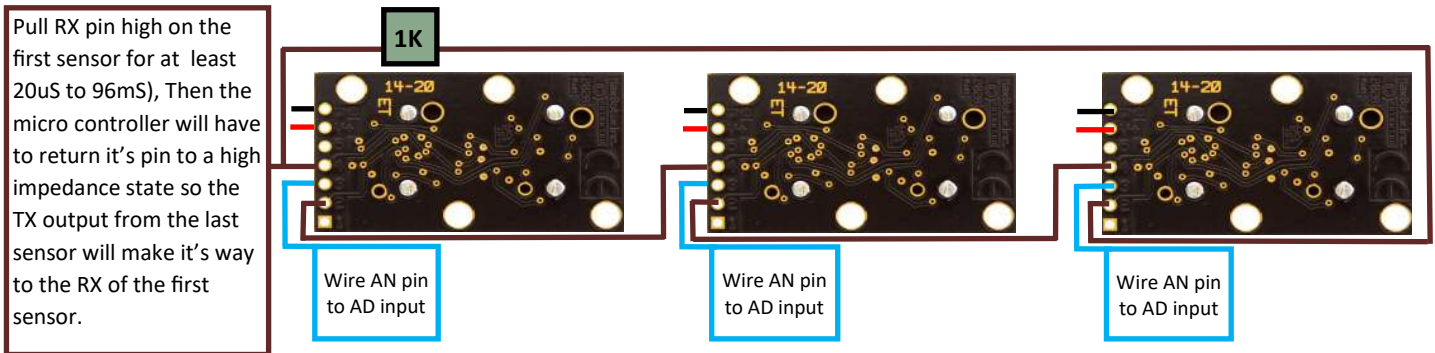

## Operating Modes Cont.

### Independent Sensor Operation

The HRLV-ShortRange-EZ sensors have the capability to operate independently when the user desires. When using the HRLV-ShortRange-EZ sensors in single or independent sensor operation, it is easiest to allow the sensor to free-run. Free-run is the default mode of operation for all of the MaxBotix Inc., sensors. The HRLV-ShortRange-EZ sensors have three separate outputs that update the range data simultaneously: Analog Voltage, Pulse Width, and Serial Data. Below are diagrams on how to connect the sensor for each of the three outputs when operating in a single or independent sensor operating environment.

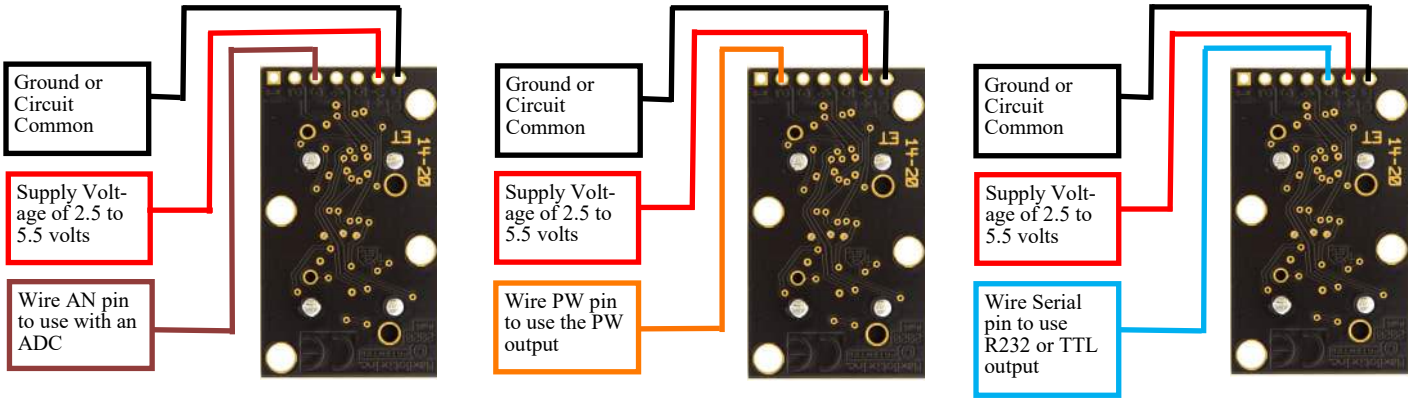

## Operations and Timing

### Power Up Timing

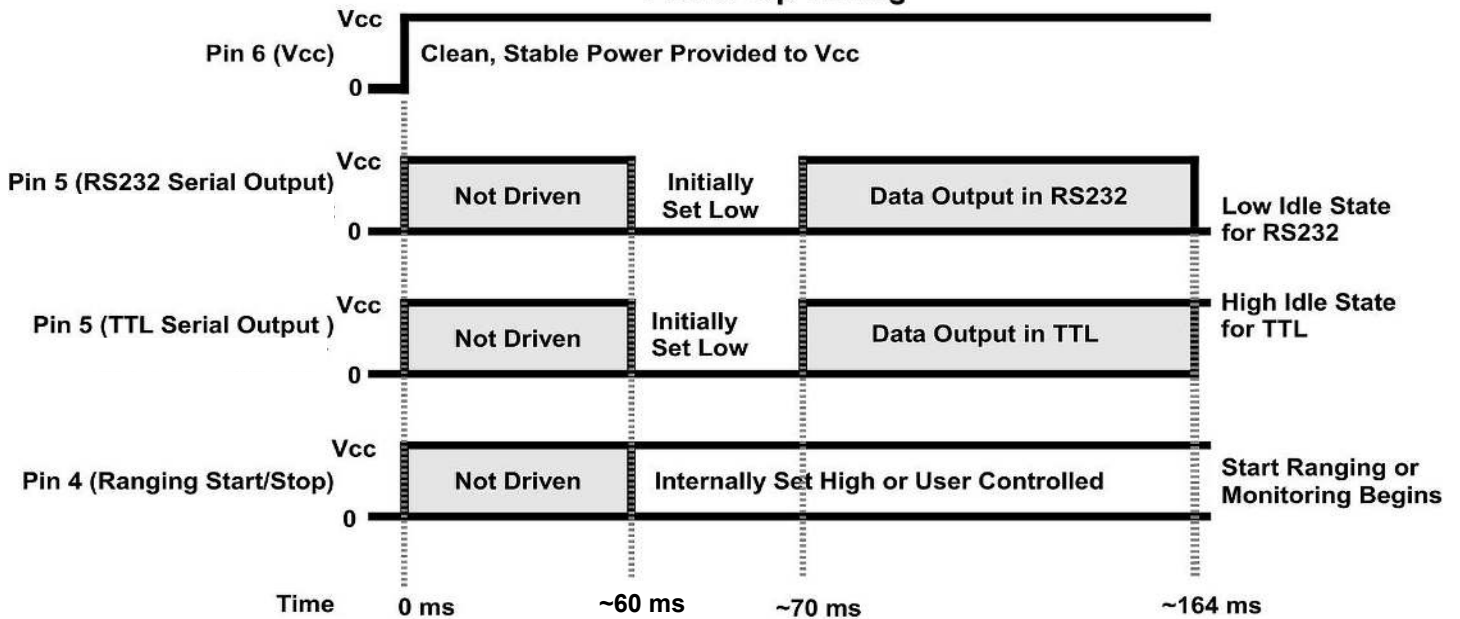

## Operations and Timing Continued

### Real-Time Operation - Triggered

Real-time or triggered operation allows users to take advantage of a few functions unavailable during free run mode. By operating in triggered mode, a maximum refresh rate of 10Hz can be achieved. This can be valuable for instance, as triggered operation allows users to range targets moving away from or closer to the sensor faster than 240mm/s.

Users can enter and remain in the Real-time or Triggered Operation by making sure that after each range cycle, the voltage level on Pin 4 is set low. After the sensor has completed the last reading, then the voltage on Pin 4 is brought high. This starts a brand new range cycle and the HRLV-ShortRange-EZ will output the most recent range data without filtering. Please reference the Real-time Triggered Operation timing diagram for full implementation details.

Readings during triggered operation are less accurate than the 2Hz filtered readings by about +/- 5-mm. Also, because the range readings are not filtered, noise tolerance can be greatly reduced. Take care to make sure that only one sensor is sampling range at a time.

### Realtime Triggered Operation

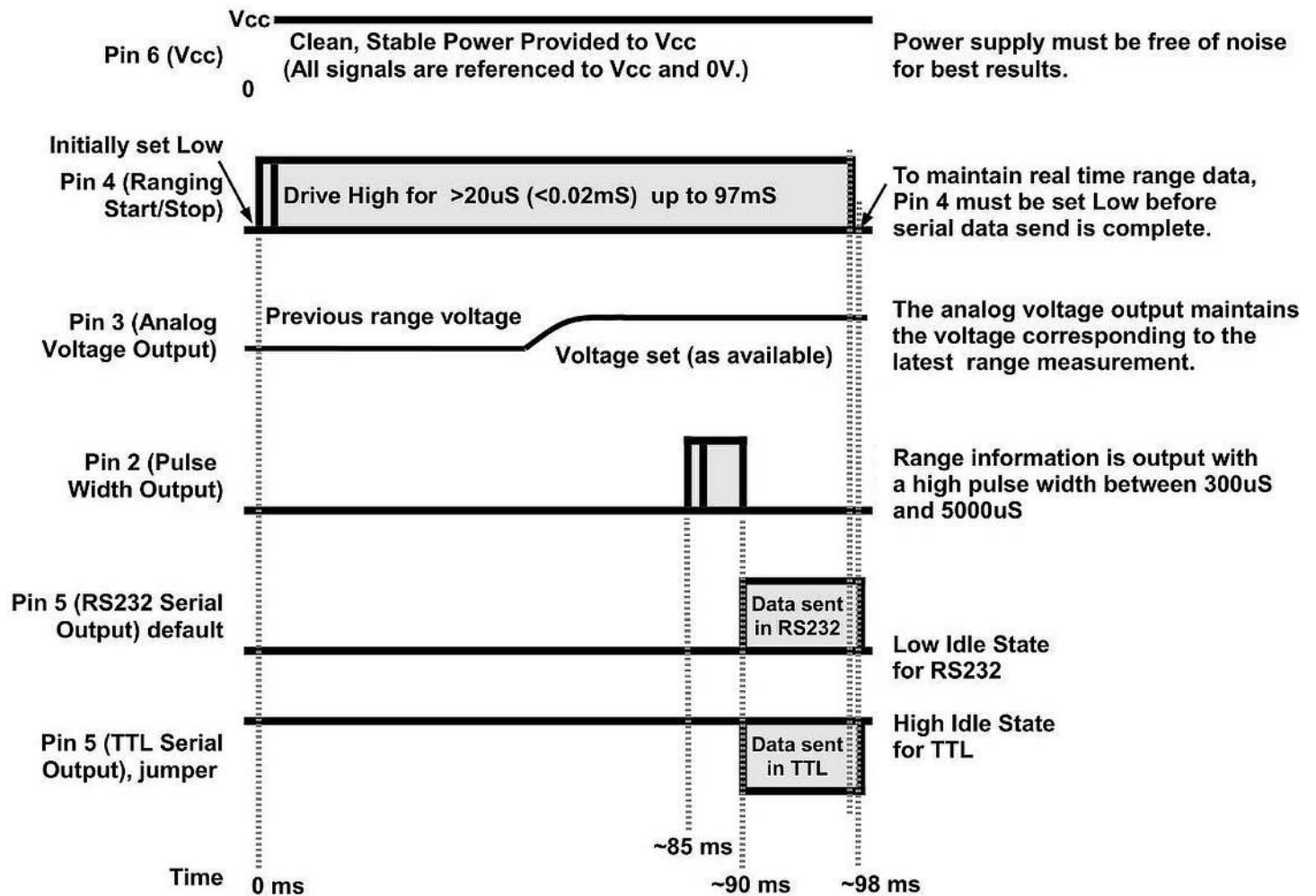



## Operations and Timing Continued

### Sensor Operation - Free-Run

When operating in free run mode, the HRLV-ShortRange-EZ sensors are designed to be used in a variety of indoor environments. Many acoustic noise sources will have little to no affect on the reported range of the HRLV-ShortRange-EZ sensors.

Most range readings are accurately reported. If the range readings are affected, the effect is typically less than 5-mm. This allows users to employ real-time ultrasonic distance sensing without the need for additional supporting circuitry or complicated user software.

### Filtered Operation - Free-Run

The HRLV-ShortRange-EZ uses an internal 2Hz bandwidth filter to process range data; which reports the latest range every 100mS or 10Hz. This improves the sensor's performance for accuracy, noise rejection, and reading to reading stability. The filtering in the free-run operation also permits additional acoustic and electrical noise tolerance.

### Filtered Freerun Operation

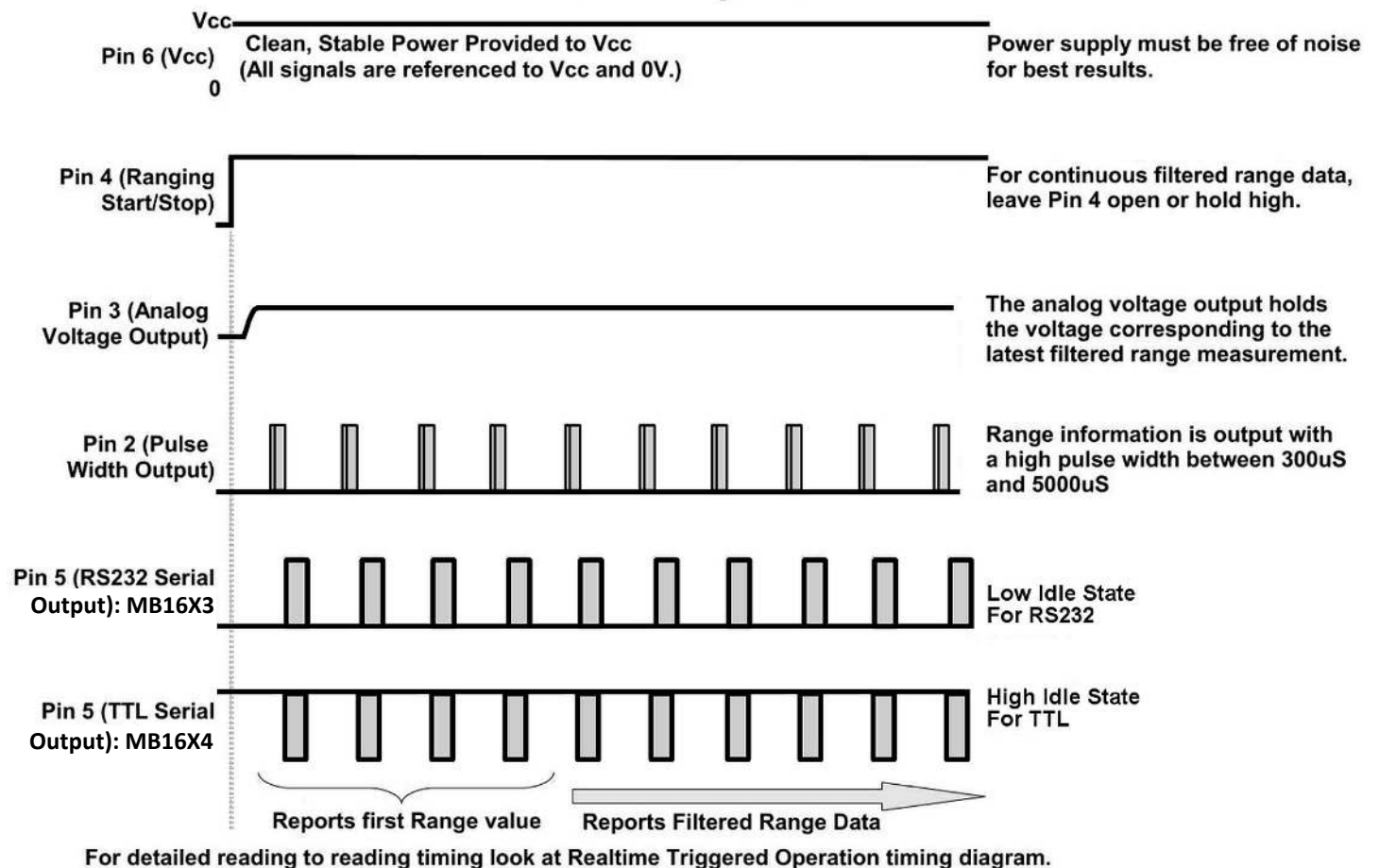

## HRLV-ShortRange® -EZ™ Beam Patterns

### Background Information Regarding our Beam Patterns

Each HRLV-ShortRange-EZ sensor has a calibrated beam pattern. Each sensor is matched to provide the approximate detection pattern shown in this datasheet. This allows end users to select the part number that matches their given sensing application. Each part number has a consistent field of detection so additional units of the same part number will have similar beam patterns. The beam plots are provided to help identify an estimated detection zone for an application based on the acoustic properties of a target versus the plotted beam patterns.

Each beam pattern is a 2D representation of the detection area of the sensor. The beam pattern is actually shaped like a 3D cone (having the same detection pattern both vertically and horizontally). Detection patterns for dowels are used to show the beam pattern of each sensor. Dowels are long cylindered targets of a given diameter. The dowels provide consistent target detection characteristics for a given size target which allows easy comparison of one MaxSonar sensor to another MaxSonar sensor.

For each part number, the four patterns (A, B, C, and D) represent the detection zone for a given target size. Each beam pattern shown is determined by the sensor's part number and target size.

The actual beam angle changes over the full range. Use the beam pattern for a specific target at any given distance to calculate the beam angle for that target at the specific distance. Generally, smaller targets are detected over a narrower beam angle and a shorter distance. Larger targets are detected over a wider beam angle and a longer range.

**People Sensing:**  
For users that desire to detect people, the detection area to the 1-inch diameter dowel, in general, represents the area that the sensor will reliably detect people.

### Beam Pattern Target Shapes

- A 6.1-mm (0.25-inch) diameter dowel 4ft length
- B 2.54-cm (1-inch) diameter dowel 4ft length
- C 8.89-cm (3.5-inch) diameter dowel 4ft length
- D 11-inch wide board 4ft in length moved left to right with the board parallel to the front sensor face. This shows the sensor's range capability.

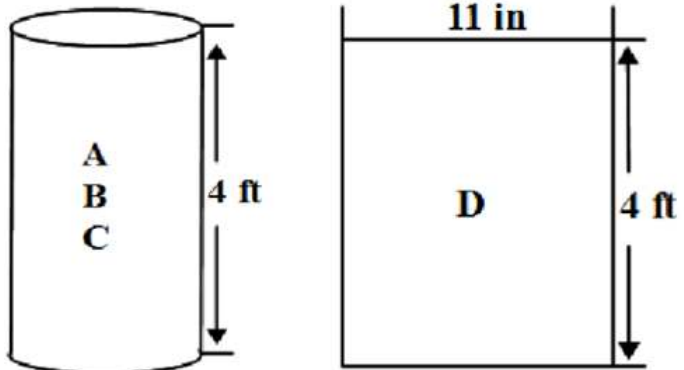

## MB1603 & MB1604 HRLV-ShortRange-EZ0 Beam Pattern and Uses

The HRLV-ShortRange-EZ0 is the highest sensitivity and widest beam sensor of the HRLV-ShortRange-EZ sensor series. The wide beam makes this sensor ideal for a variety of applications including people detection, autonomous navigation, and wide beam applications.

# MB1603-000 MB1604-050

## HRLV-ShortRange®-EZ0™ Beam Pattern

Sample results for measured beam pattern are shown on a 30-cm grid. The detection pattern is shown for dowels of varying diameters that are placed in front of the sensor.

A 6.1-mm (0.25-inch) diameter dowel

B 2.54-cm (1-inch) diameter dowel

C 8.89-cm (3.5-inch) diameter dowel

D 11-inch wide board moved left to right with the board parallel to the front sensor face.

This shows the sensor's range capability.

**Note:** For people detection the pattern typically falls between charts A and B.

..... Partial Detection

— 5.0V

● 3.3V

— 2.7V

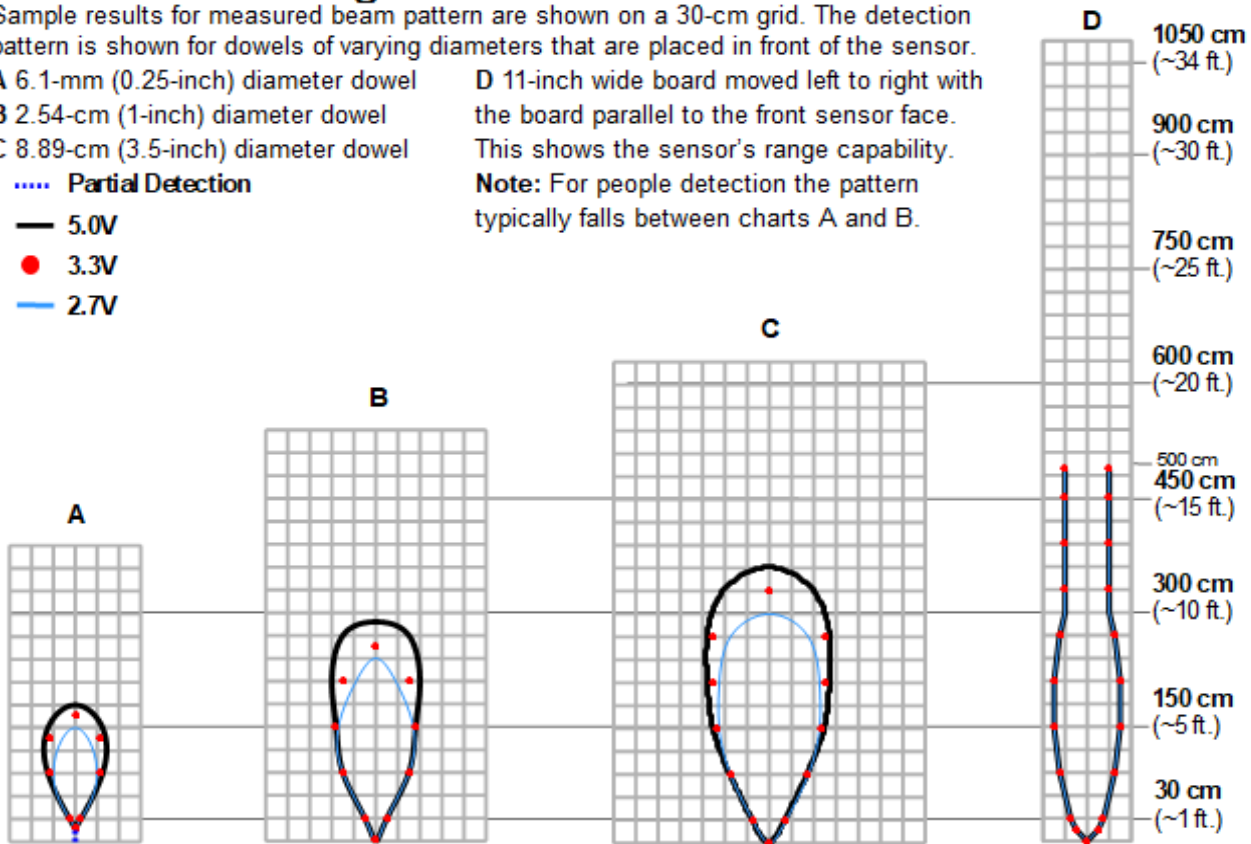

**Beam Characteristics are Approximate**

Beam Pattern drawn to a 1:95 scale for easy comparison to our other products.

### MB1603 & MB1604 Features and Benefits

- Factory calibrated wide beam width
- All range outputs are active simultaneously
- High acoustic sensitivity
- Detects small targets to longer distances
- Widest beam width for the HRLV-ShortRange-EZ sensors

### MB1603 & MB1604 Applications and Uses

- People detection
- Small target detection
- High sensitivity applications
- Obstacle avoidance

## MB1613 & 1614 HRLV-ShortRange-EZ1 Beam Pattern and Uses

The HRLV-ShortRange-EZ1 is an indoor ultrasonic sensor and is a quality, low-cost starting place for a customer not sure of which HRLV-ShortRange-EZ sensor to use. It balances the detection of people and other objects with a narrow beam width.

# MB1613-000 MB1614-050

## HRLV-ShortRange®-EZ1™ Beam Pattern

Sample results for measured beam pattern are shown on a 30-cm grid. The detection pattern is shown for dowels of varying diameters that are placed in front of the sensor.

A 6.1-mm (0.25-inch) diameter dowel

B 2.54-cm (1-inch) diameter dowel

C 8.89-cm (3.5-inch) diameter dowel

..... Partial Detection

— 5.0V

● 3.3V

— 2.7V

D 11-inch wide board moved left to right with the board parallel to the front sensor face.

This shows the sensor's range capability.

Note: For people detection the pattern typically falls between charts A and B.

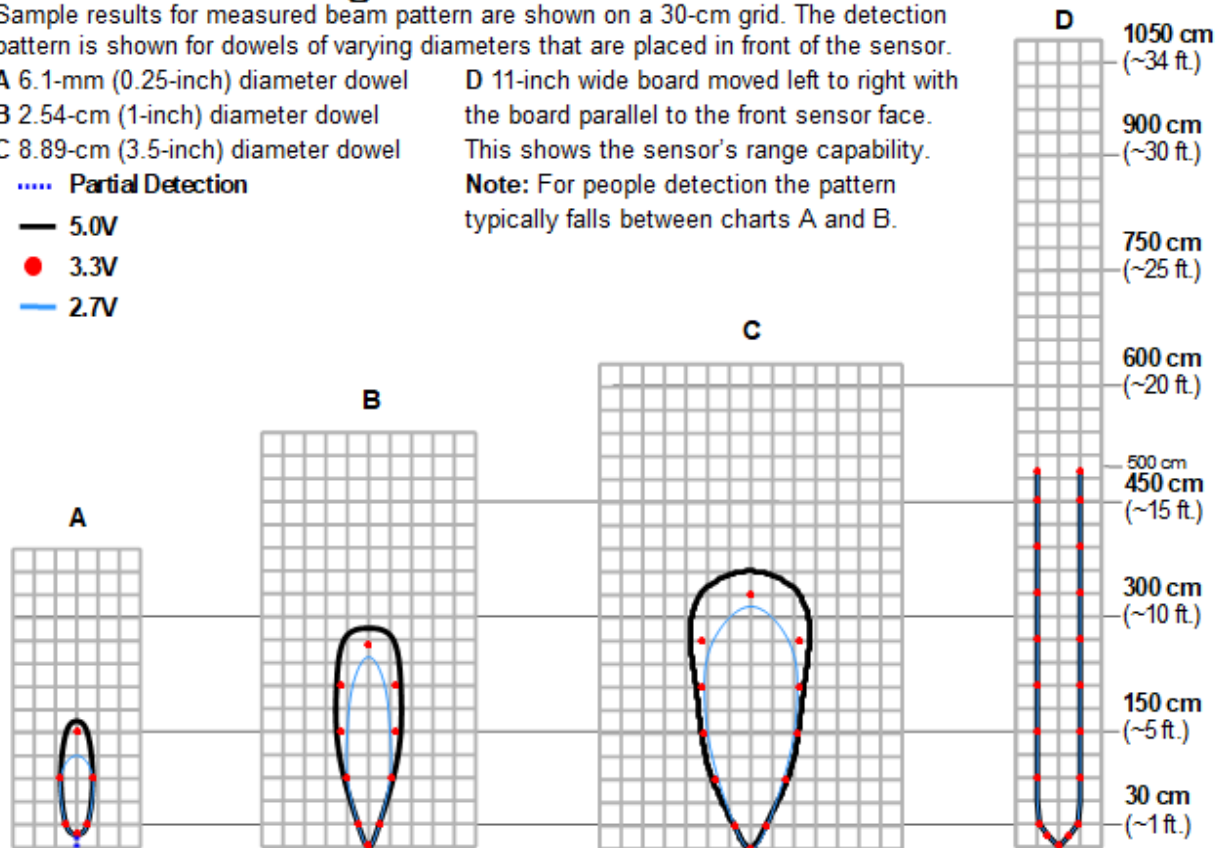

Beam Characteristics are Approximate

Beam Pattern drawn to a 1:95 scale for easy comparison to our other products.

### MB1613 & MB1614 Features and Benefits

- Good balance between people detection and beam pattern width
- Well balanced acoustic sensitivity
- Ignores some small targets
- Detects most targets to long distances
- Wider, balanced beam width
- Sensitive long narrow beam

### MB1613 & MB1614 Applications and Uses

- Our most recommended HRLV-ShortRange-EZ Sensor
- People Detection
- Well balanced detection
- Autonomous Navigation

## MB1623 & 1624 HRLV-ShortRange-EZ2 Beam Pattern and Uses

The HRLV-ShortRange-EZ2 is an effective compromise between sensitivity and side object rejection. The HRLV-ShortRange-EZ2 is an excellent choice for applications that requires slightly less side object detection and sensitivity than the HRLV-ShortRange-EZ1.

# MB1623-000 MB1624-050

## HRLV-ShortRange®-EZ2™ Beam Pattern

Sample results for measured beam pattern are shown on a 30-cm grid. The detection pattern is shown for dowels of varying diameters that are placed in front of the sensor.

A 6.1-mm (0.25-inch) diameter dowel

B 2.54-cm (1-inch) diameter dowel

C 8.89-cm (3.5-inch) diameter dowel

..... Partial Detection

— 5.0V

● 3.3V

— 2.7V

D 11-inch wide board moved left to right with the board parallel to the front sensor face.

This shows the sensor's range capability.

Note: For people detection the pattern typically falls between charts A and B.

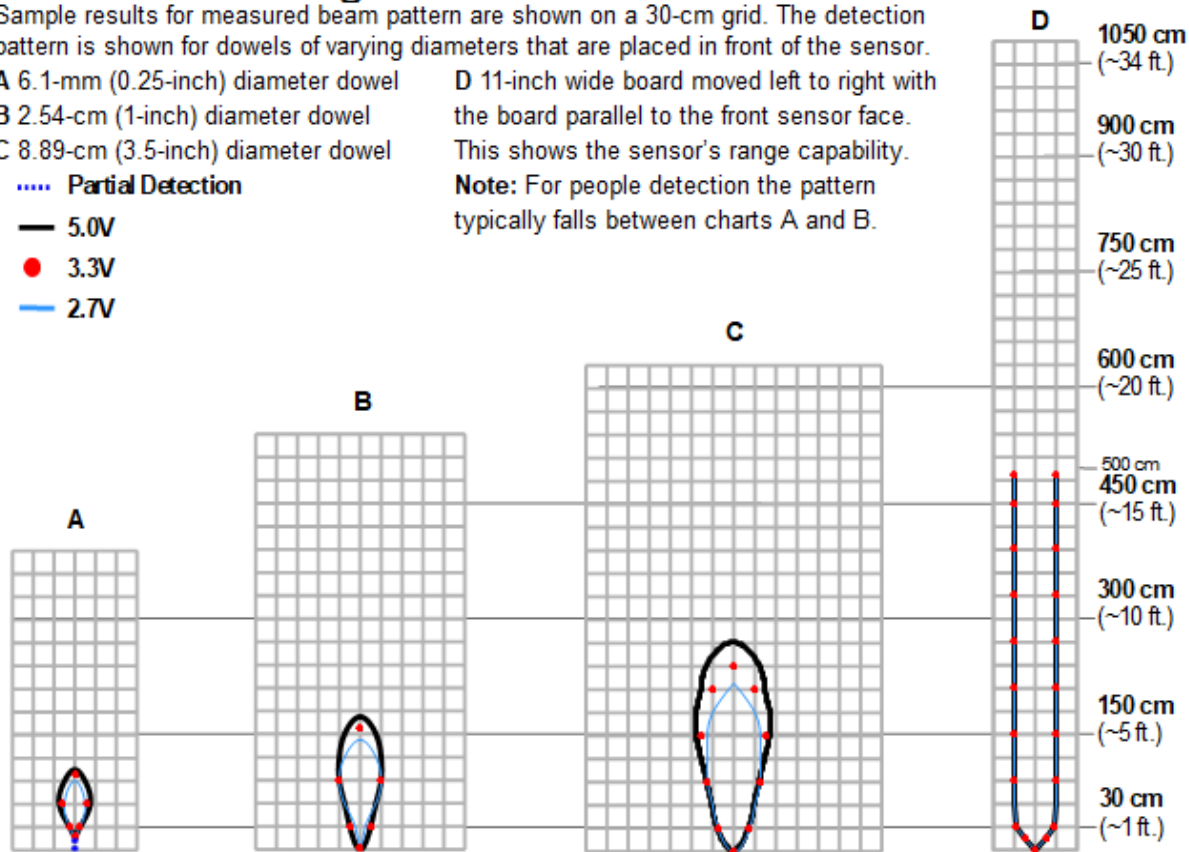

Beam Characteristics are Approximate

Beam Pattern drawn to a 1:95 scale for easy comparison to our other products.

### MB1623 & MB1624 Features and Benefits

- Good balance between high sensitivity and noise tolerance
- Well balanced acoustic sensitivity
- Ignores some small targets
- Detects most targets to long distances
- Balanced Beam Width
- Best compromise for beam width, sensitivity and sensor range

### MB1623 & MB1624 Applications and Uses

- Well balanced detection
- Applications where the HRLV-ShortRange-EZ1 is too wide

## MB1633 & 1634 HRLV-ShortRange-EZ3 Beam Pattern and Uses

The HRLV-ShortRange-EZ3 is a sensor with a narrow beam and good side object rejection. The HRLV-ShortRange-EZ3 has slightly wider beam width than the HRLV-ShortRange-EZ4 which makes it a good choice for when the HRLV-ShortRange-EZ4 does not have enough sensitivity for the application.

# MB1633-000 MB1634-050

## HRLV-ShortRange®-EZ3™ Beam Pattern

Sample results for measured beam pattern are shown on a 30-cm grid. The detection pattern is shown for dowels of varying diameters that are placed in front of the sensor.

A 6.1-mm (0.25-inch) diameter dowel

B 2.54-cm (1-inch) diameter dowel

C 8.89-cm (3.5-inch) diameter dowel

..... Partial Detection

— 5.0V

● 3.3V

— 2.7V

D 11-inch wide board moved left to right with

the board parallel to the front sensor face.

This shows the sensor's range capability.

**Note:** For people detection the pattern typically falls between charts A and B.

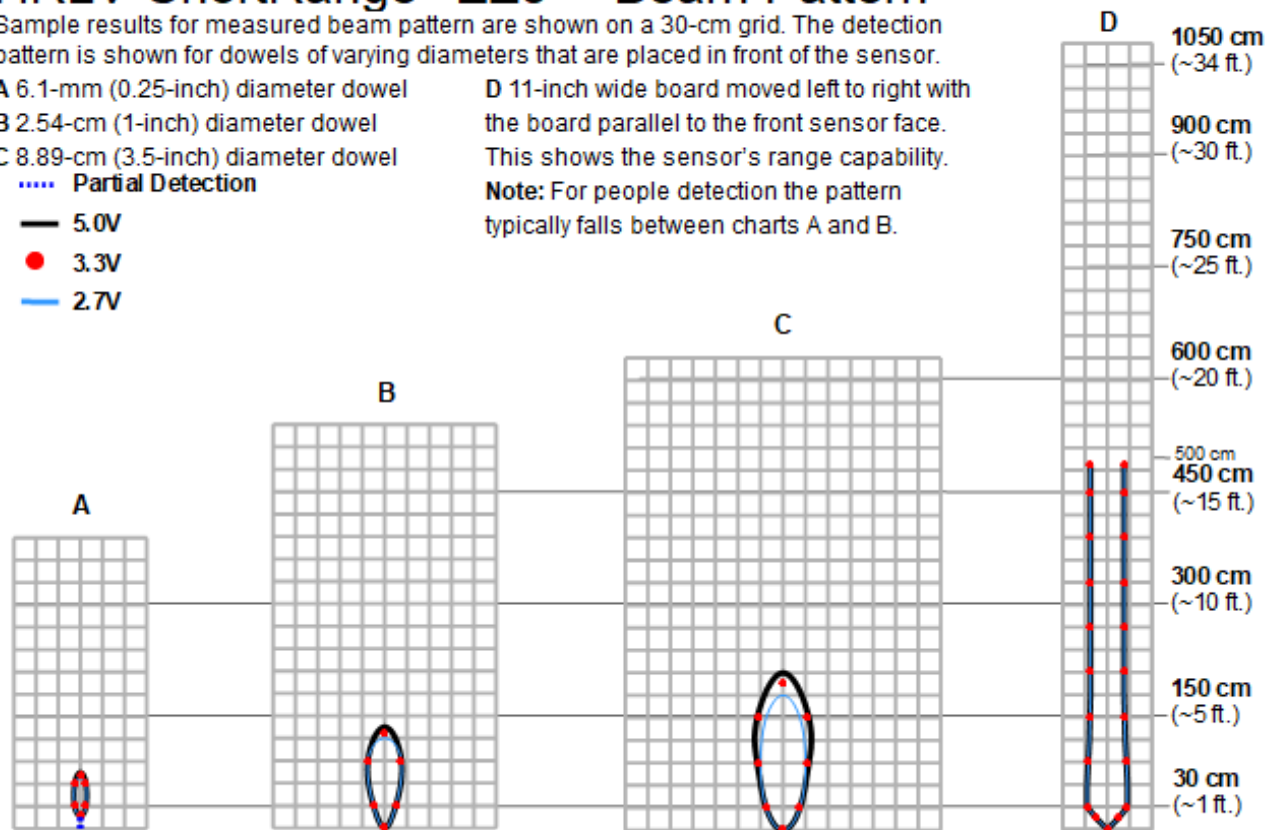

**Beam Characteristics are Approximate**

Beam Pattern drawn to a 1:95 scale for easy comparison to our other products.

### MB1633 & MB1634

#### Features and Benefits

- More sensitive than the HRLV-ShortRange-EZ4
- More noise tolerant acoustic sensitivity
- Ignores some small targets and medium targets
- Detects most targets to long distances
- Narrow Beam Width

### MB1633 & MB1634

#### Applications and Uses

- Large target detection
- Short range medium target detection
- Applications requiring high noise tolerance

## MB1643 & 1644 HRLV-ShortRange-EZ4 Beam Pattern and Uses

The HRLV-ShortRange-EZ4 is the narrowest beam width sensor which is also the least sensitive to side objects offered in the HRLV-ShortRange-EZ sensor line. The HRLV-ShortRange-EZ4 is an excellent choice when only larger objects need to be detected.

# MB1643-000 MB1644-050

## HRLV-ShortRange®-EZ4™ Beam Pattern

Sample results for measured beam pattern are shown on a 30-cm grid. The detection pattern is shown for dowels of varying diameters that are placed in front of the sensor.

A 6.1-mm (0.25-inch) diameter dowel

B 2.54-cm (1-inch) diameter dowel

C 8.89-cm (3.5-inch) diameter dowel

..... Partial Detection

— 5.0V

● 3.3V

— 2.7V

D 11-inch wide board moved left to right with the board parallel to the front sensor face.

This shows the sensor's range capability.

Note: For people detection the pattern typically falls between charts A and B.

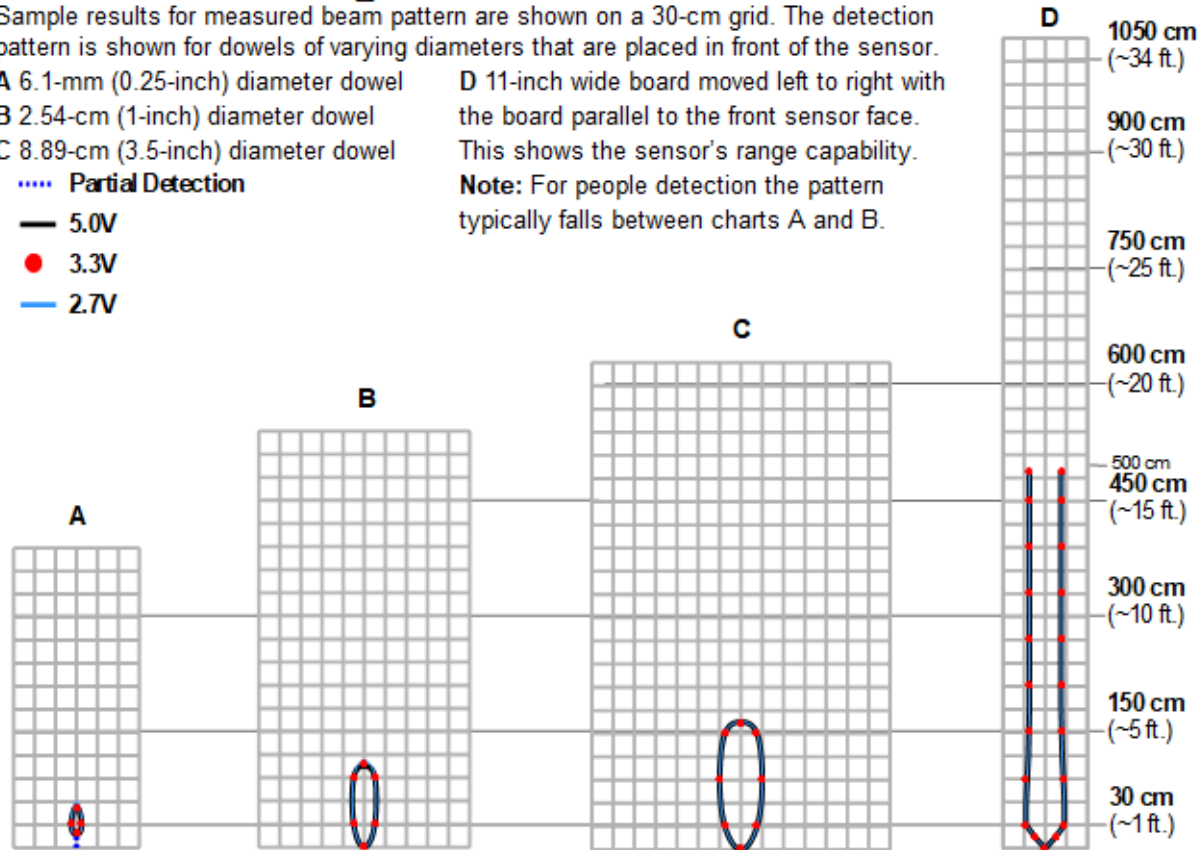

Beam Characteristics are Approximate

Beam Pattern drawn to a 1:95 scale for easy comparison to our other products.

### MB1643 & MB1644 Features and Benefits

- Best noise tolerance of the HRLV -ShortRange-EZ sensors
- Most noise tolerant acoustic sensitivity
- Ignores some small targets and medium targets
- Detects most large targets to long distances
- Narrow beam width

### MB1643 & MB1644 Applications and Uses

- Large target detection
- Applications requiring high noise tolerance

**Part Numbers**

All part numbers are a combination of a six-character base followed by a dash and a three-digit product code. Please review the following table for more information on the three-digit product code.

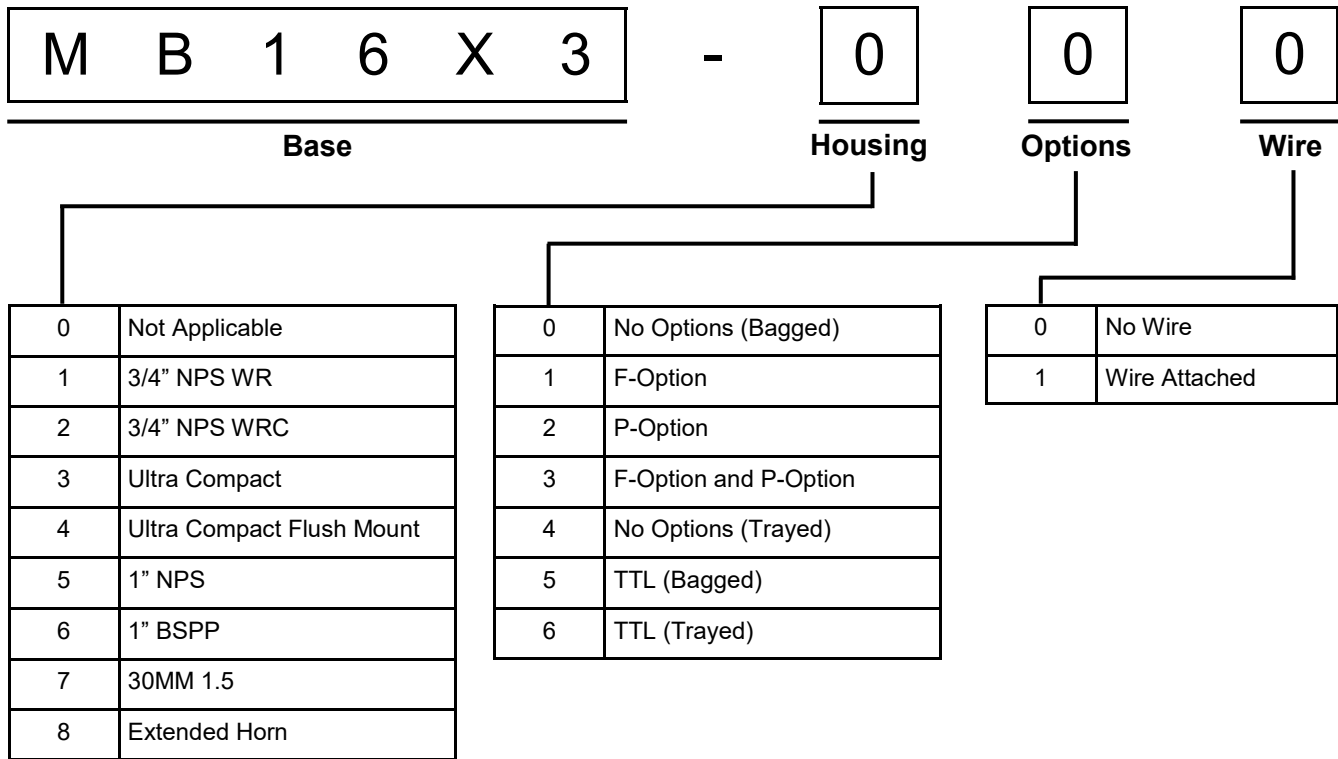

The following table displays all of the active and valid part numbers for this product.

Active Part Numbers for MB1603, MB1604, MB1613, MB1614, MB1623, MB1624, MB1633, MB1634, MB1643 and MB1644				
MB1603-000	MB1613-000	MB1623-000	MB1633-000	MB1643-000
MB1603-040	MB1613-040	MB1623-040	MB1633-040	MB1643-040
MB1604-050	MB1614-050	MB1624-050	MB1634-050	MB1644-050
MB1604-060	MB1614-060	MB1624-060	MB1634-060	MB1644-060



## After reviewing this datasheet, do you have any more questions?

We offer Technical Support on all of our products even if you purchased them through one of our many vendors worldwide.

You can **fill out a Technical Support form** for assistance on a sensor here --> [Technical Support](#)

## Not sure which sensor you need for your application?

We offer Sensor Selection Assistance, click the link here to fill out a form for support --> [Sensor Selection Help](#)

## Looking for tutorials to help you get started?

### [Frequently Asked Questions about Our Sensors](#)

We receive many questions about our products and services. This resource offers answers to common inquiries we receive about our product lines and their application.

### [Fully Calibrated Beam Patterns](#)

All of our sensors are factory calibrated to provide consistent beam patterns, detection zones, to fit into a wide variety of applications. In our product lines, each model number comes with a different beam pattern that reflects the sensitivity and the detection zone of how it sees a target. Additionally, we strive to maintain consistency between our finished products, and you will see little to no deviation between sensors of the same model. This allows you to have confidence in your final application when using multiple sensors.

### [Understanding Range Readings](#)

The success of an application may hinge upon knowing the exact location of a target. However, a sensor may report one meter even if the target is not exactly one meter away from the sensor. Sensor specifications, such as resolution, precision, and accuracy, help you to understand sensor performance.

### [How to Use Multiple Ultrasonic Sensors](#)

This guide covers three ways to run your sensors in a Multiple Sensor environment and issues you may face.

Contact us now with any questions at [sales@maxbotix.com](mailto:sales@maxbotix.com) or call +1-218-454-0766.

Please call during our preferred business hours of 8:00 am – 4:30 pm EST on Monday through Thursday and 8:00 am – 2:00 pm EST on Friday, or you may leave us a voicemail anytime.