

Product P/N	Flex Cable P/N In Wistron	DIM"A"	DIM"B"	DIM"C"	DIM"D"	DIM"E"	BGA Array Pattern
10127624-13608XXLF	13608	16.55	14.80	12.82	22.30	93.09	6X14
10127624-13609XXLF	13609	19.40	17.65	11.36	25.15	97.12	6X17

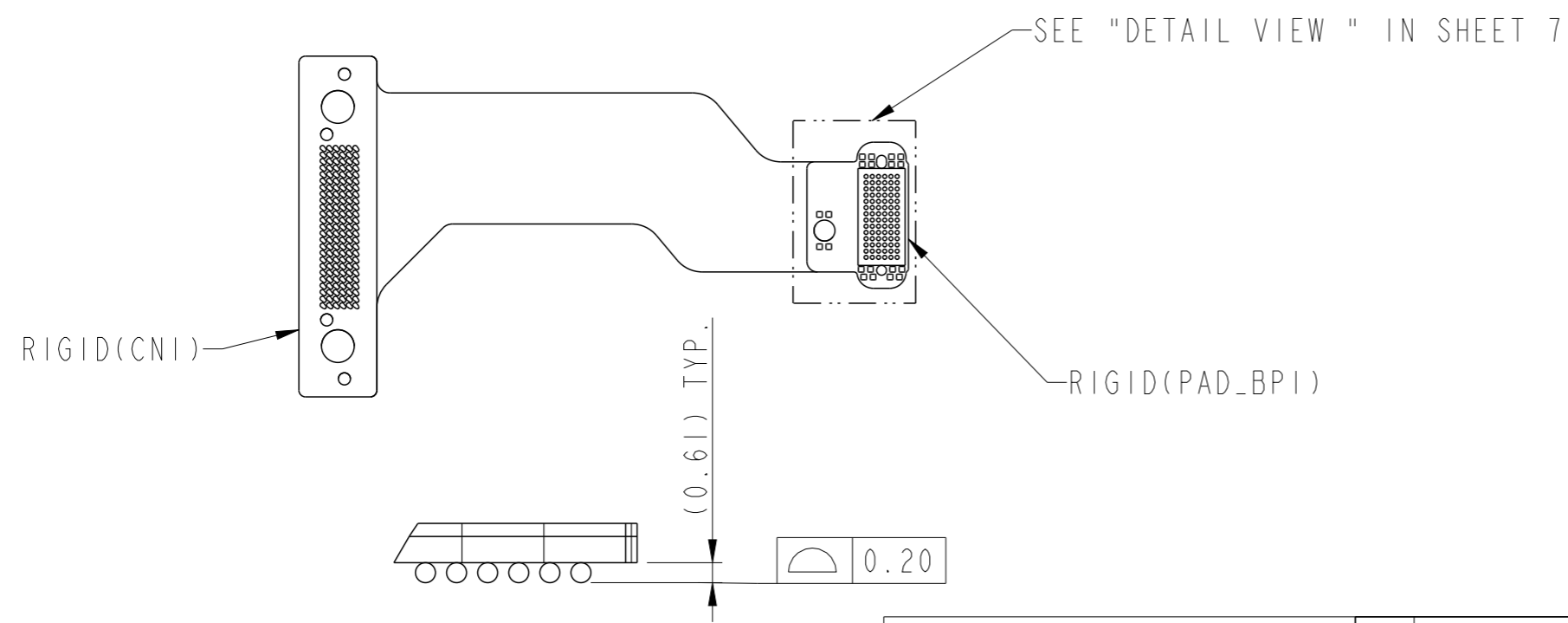
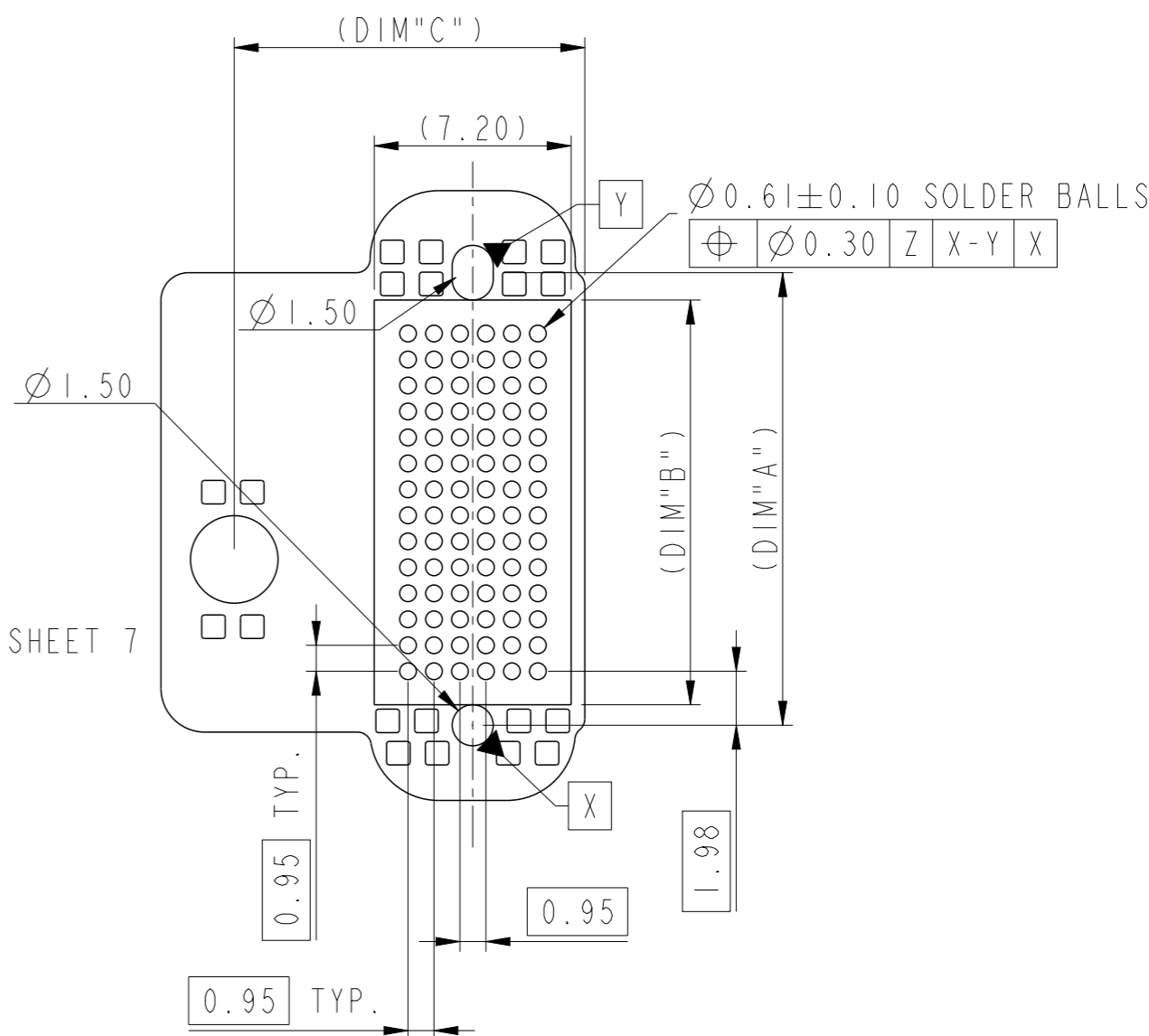
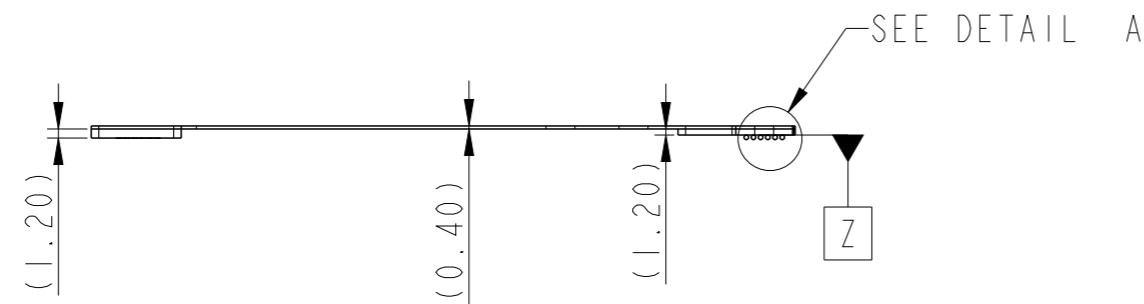
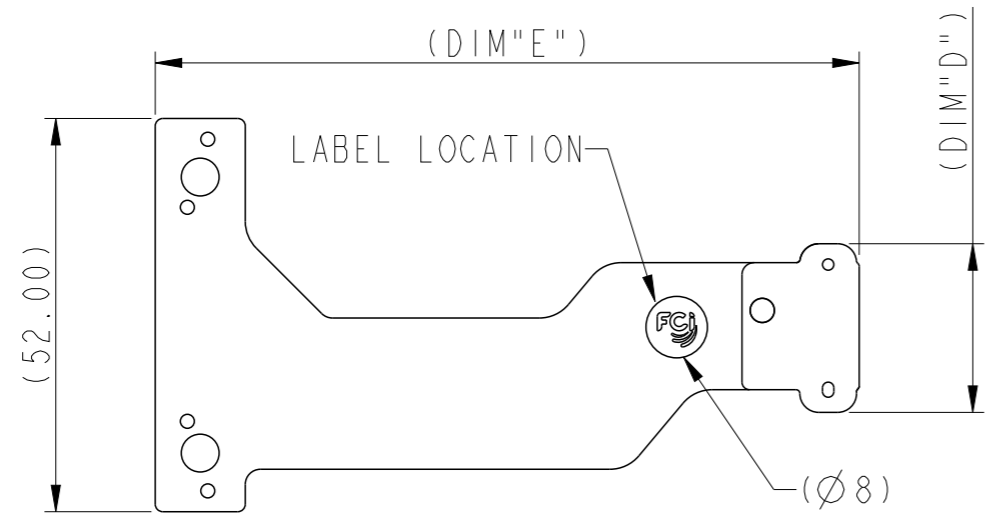

DETAIL A
SCALE 5:1

SCALE 4:1

spec ref	dr	Zhen Luo	2014/03/14	projection	MM	size	A3	scale	1:1
tolerance std	eng	Michael Song	2017/04/13			ecn no	ELX-DG-26616-1	rel level	Released
ASME Y14.5	chr	-	-						
surface linear ASME Y14.5 angular	TOLERANCES UNLESS OTHERWISE SPECIFIED		product family		-		-		
	0.X	±0.30	Amphenol FCI		title		Flex Cable BGA		
	0.XX	±0.20	www.fci.com		dwg no		10127624		
0.XXX	±0.10	cat. no.		-		Product - Customer Drw		rev	C
0°	±2°	-		-		-		sheet 1 of 7	

Product P/N	Flex Cable P/N In Wistron	DIM"A"	DIM"B"	DIM"C"	DIM"D"	BGA Array Pattern
10127624-13611XXLF	13611	16.55	14.80	22.0	81.73	6X14
10127624-13614XXLF	13614	26.05	24.30	31.50	79.38	6X24
10127624-13658XXLF	13658	15.60	13.85	31.50	79.43	6X13

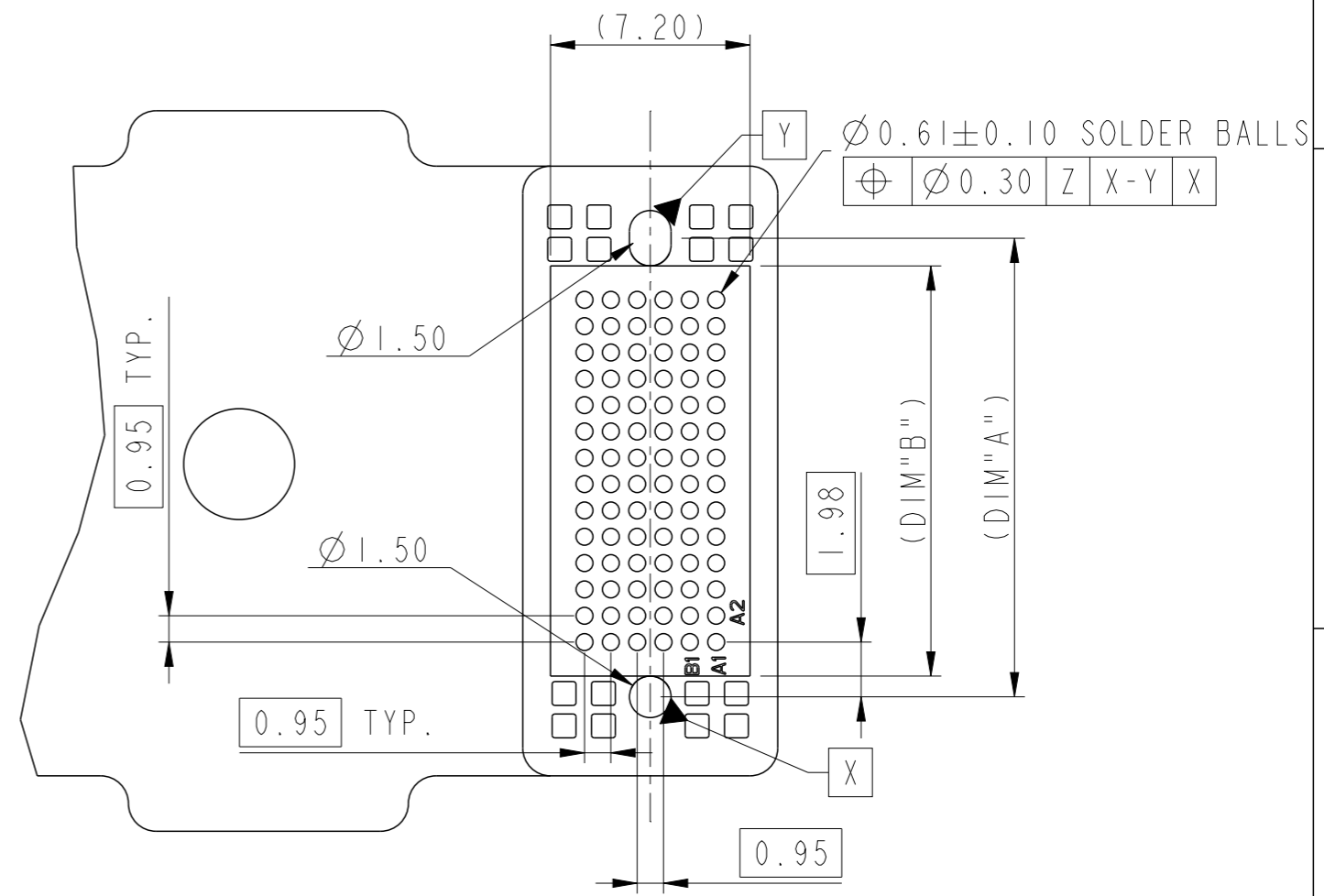
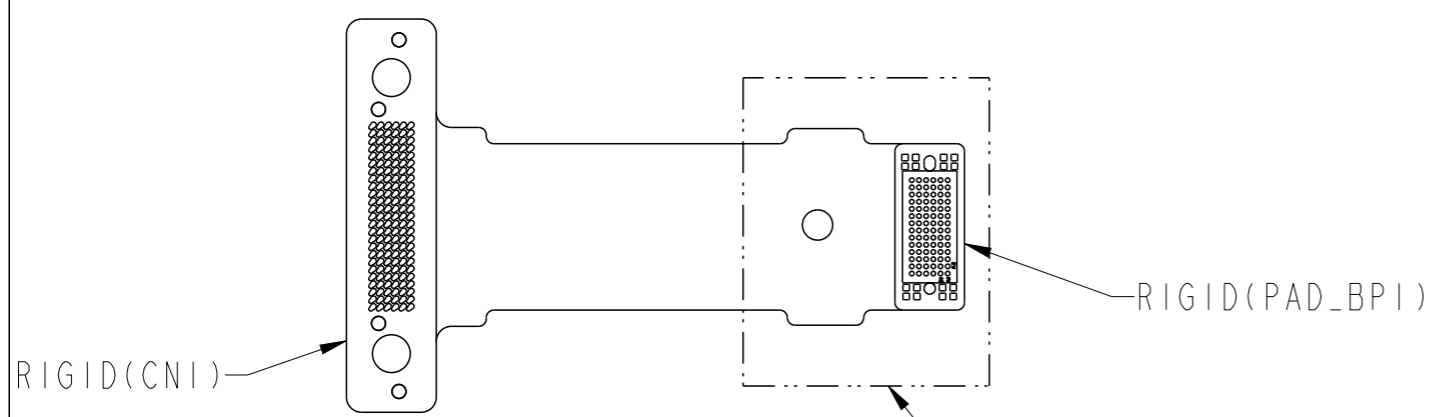
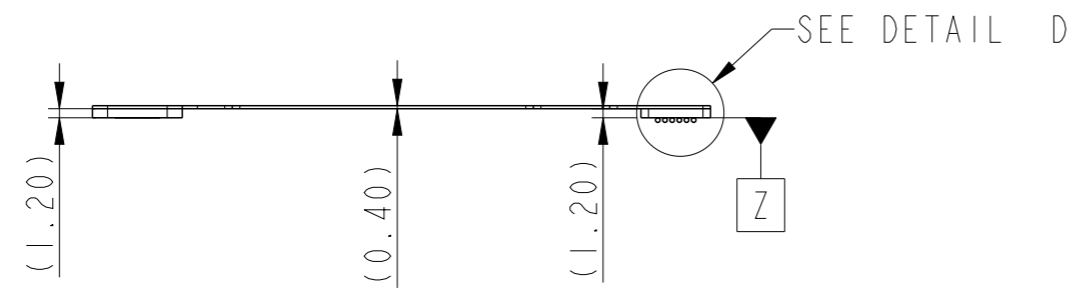
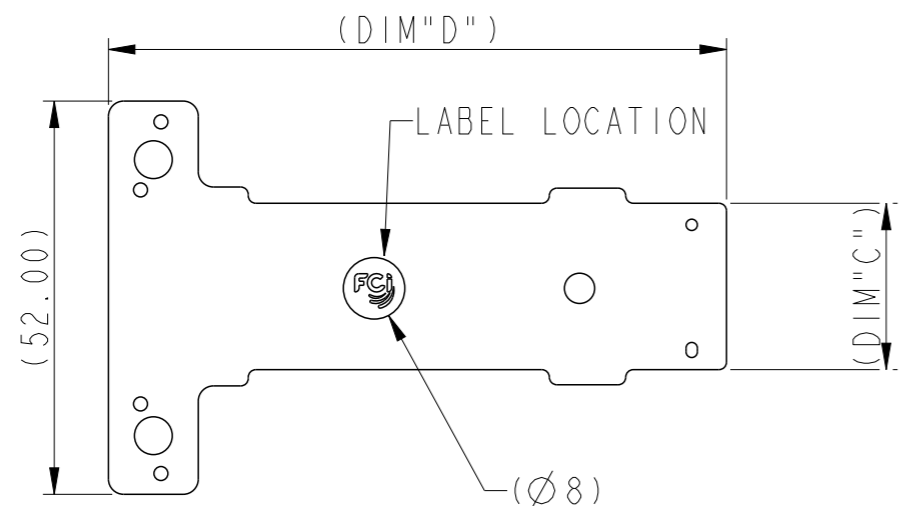

SCALE 4:1

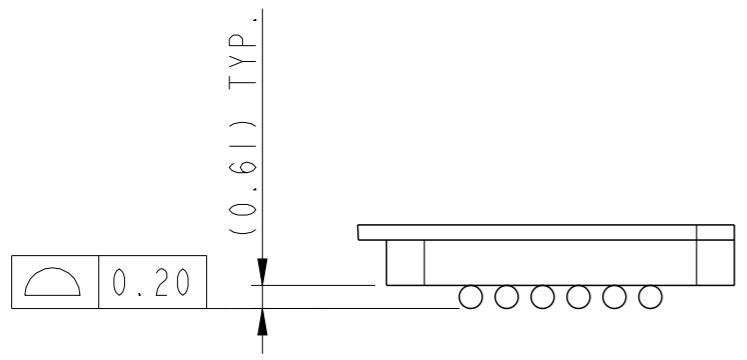

DETAIL D
SCALE 5:1

spec ref	dr	Zhen Luo	2014/03/14	projection	MM	size	A3	scale	1:1
tolerance std	eng	Michael Song	2017/04/13			ecn no	ELX-DG-26616-1	rel level	Released
ASME Y14.5	chr	-	product family						
TOLERANCES UNLESS OTHERWISE SPECIFIED		appr	Heaven Cen	product family		-		rel level	
surface	linear	0.X	±0.30	Flex Cable BGA		dwg no	10127624		rev
		0.XX	±0.20	www.fci.com				C	
		0.XXX	±0.10	cat. no.		-		Product - Customer Drw	
ASME Y14.5	angular	0°	±2°	-		Product - Customer Drw		sheet 2 of 7	

Product P/N	Flex Cable P/N In Wistron	DIM"A"	DIM"B"	DIM"C"	BGA Array Pattern
10127624-13612XXLF	13612	16.55	14.80	22.0	6X14
10127624-13616XXLF	13616	27.0	25.25	32.45	6X25

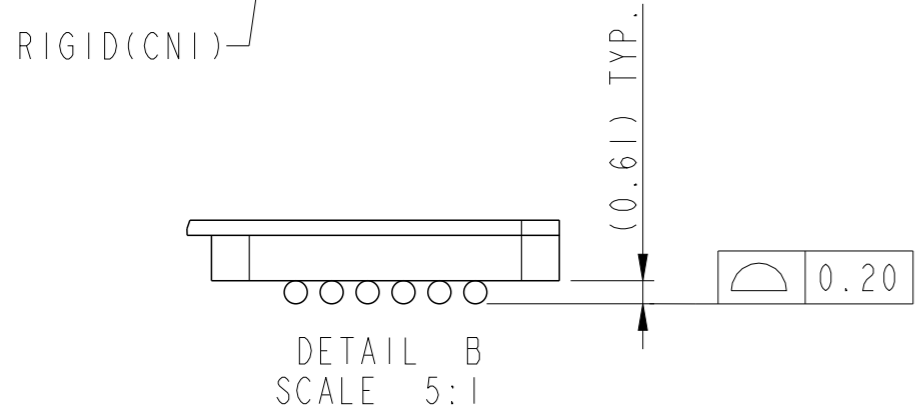
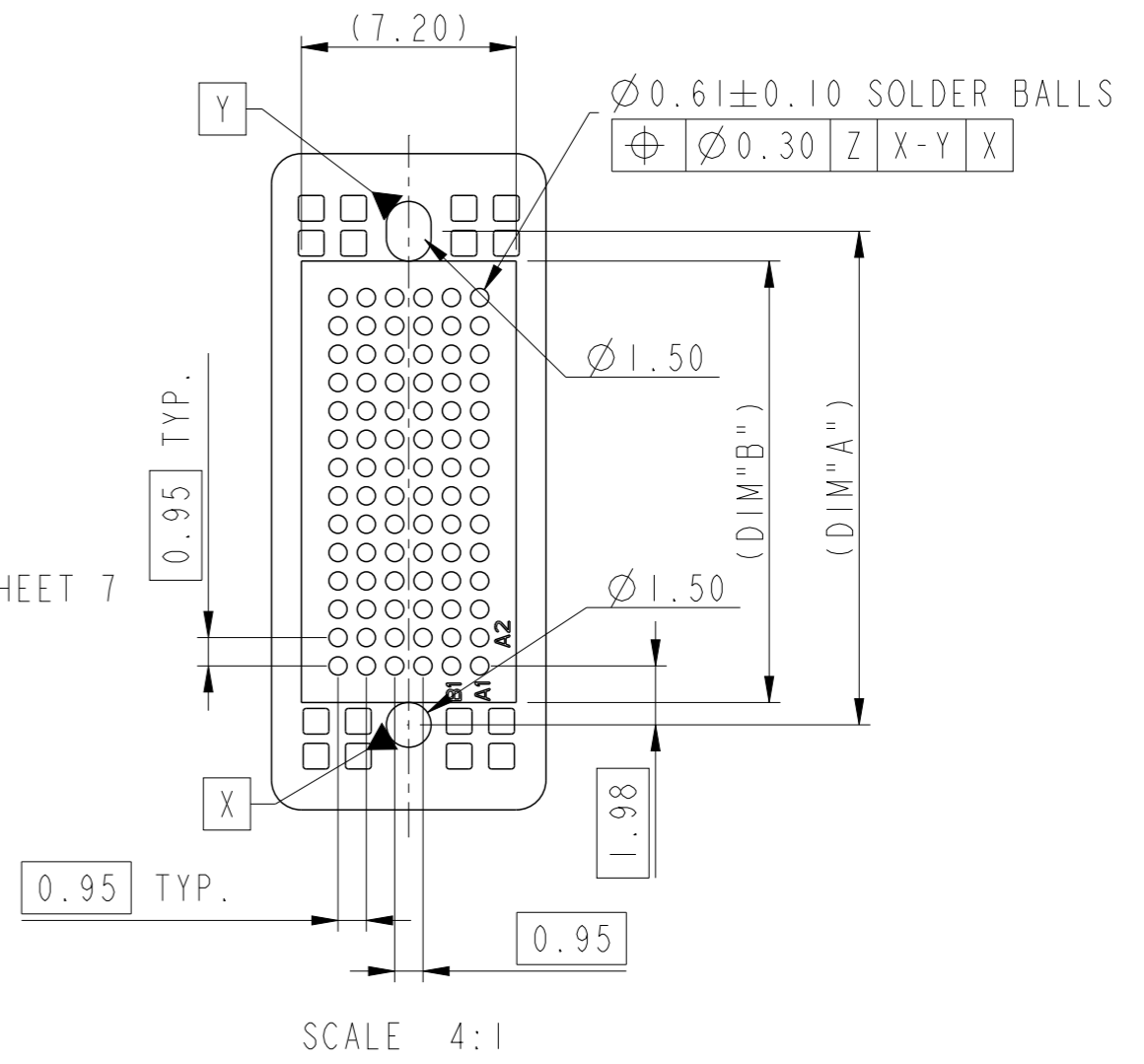
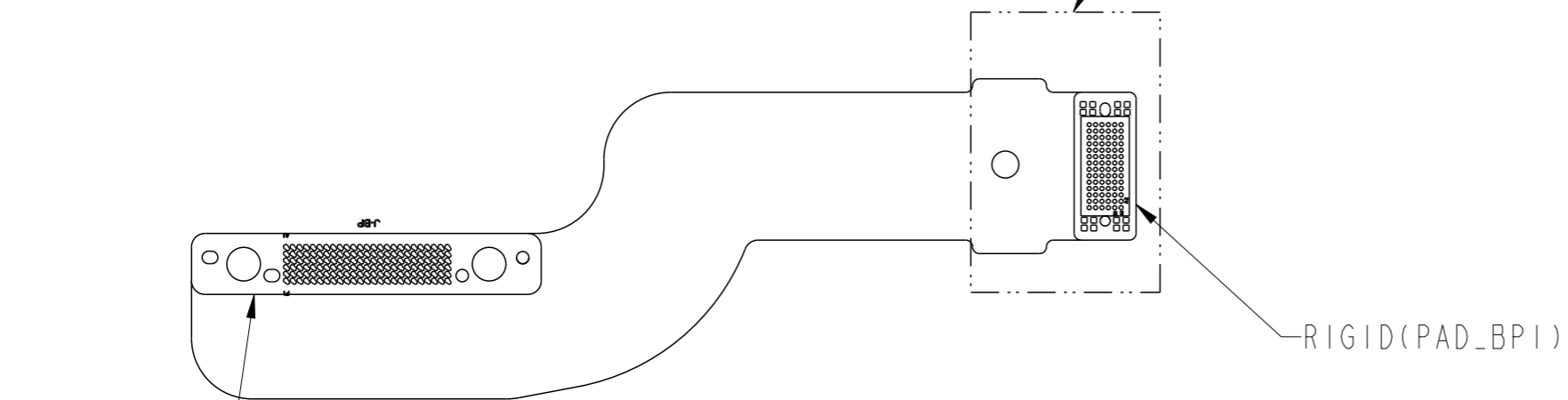
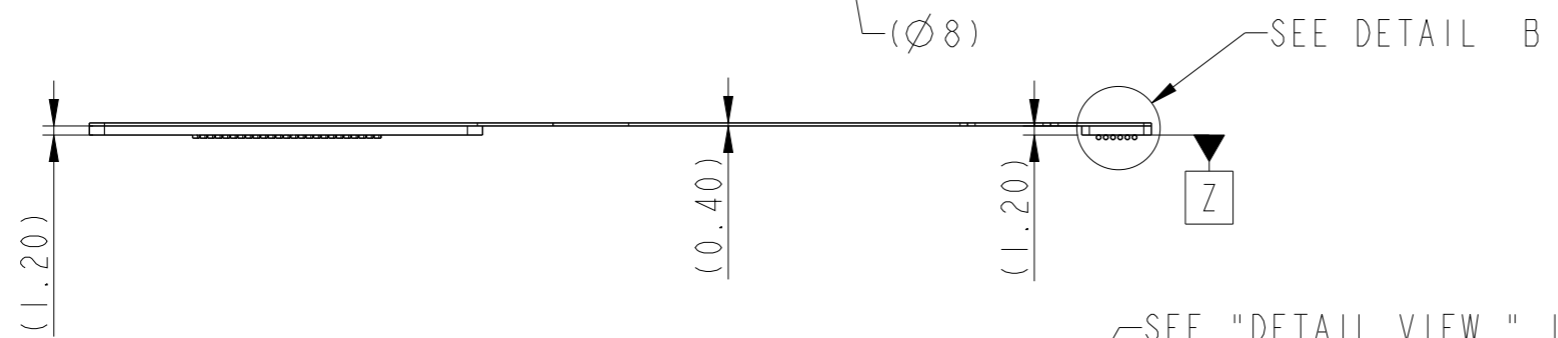
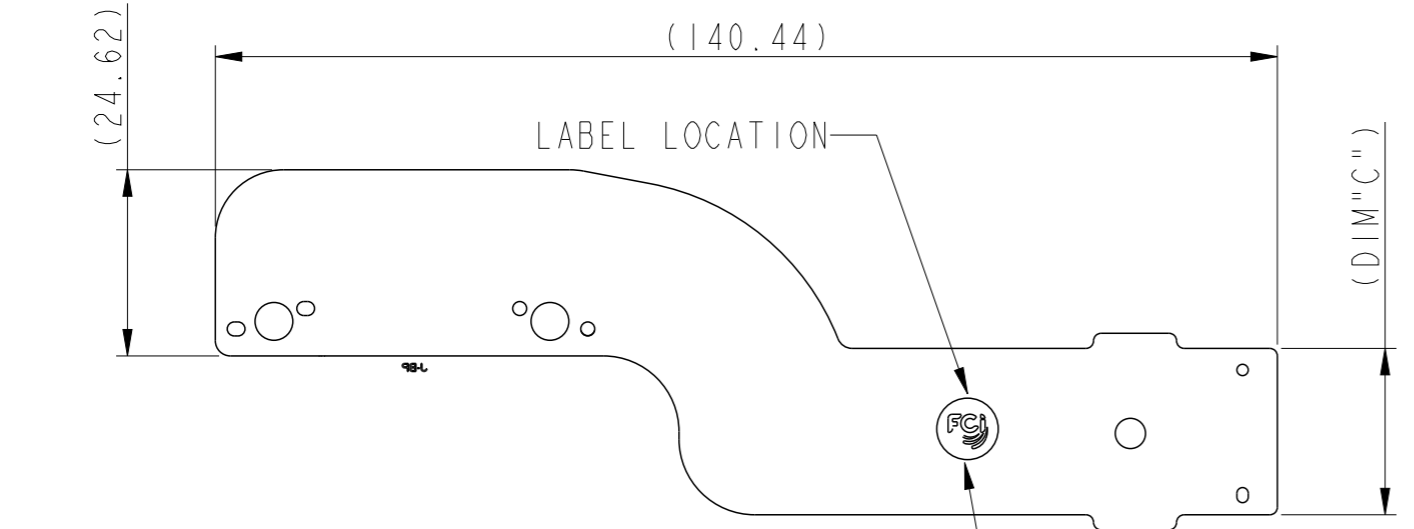

© 2016 AFCI

spec ref	dr	Zhen Luo	2014/03/14
tolerance std	eng	Michael Song	2017/04/13
ASME Y14.5	chr	-	-
	appr	Heaven Cen	2017/04/13

projection	MM	size	A3	scale	1:1
product family	-	ecn no	ELX-DG-26616-1	rel level	Released
title	Flex Cable BGA	dwg no	10127624	rev	C
www.fci.com	cat. no.	-	Product - Customer Drw	sheet 3 of 7	

Product P/N	Flex Cable P/N In Wistron	DIM"A"	DIM"B"	DIM"C"	DIM"D"	DIM"E"	BGA Array Pattern
10127624-13610XXLF	13610	27.0	25.25	12.82	32.75	151.11	6X25
10127624-13613XXLF	13613	19.40	17.65	11.36	25.15	159.14	6X17
10127624-13615XXLF	13615	16.55	14.80	12.82	22.30	151.10	6X14

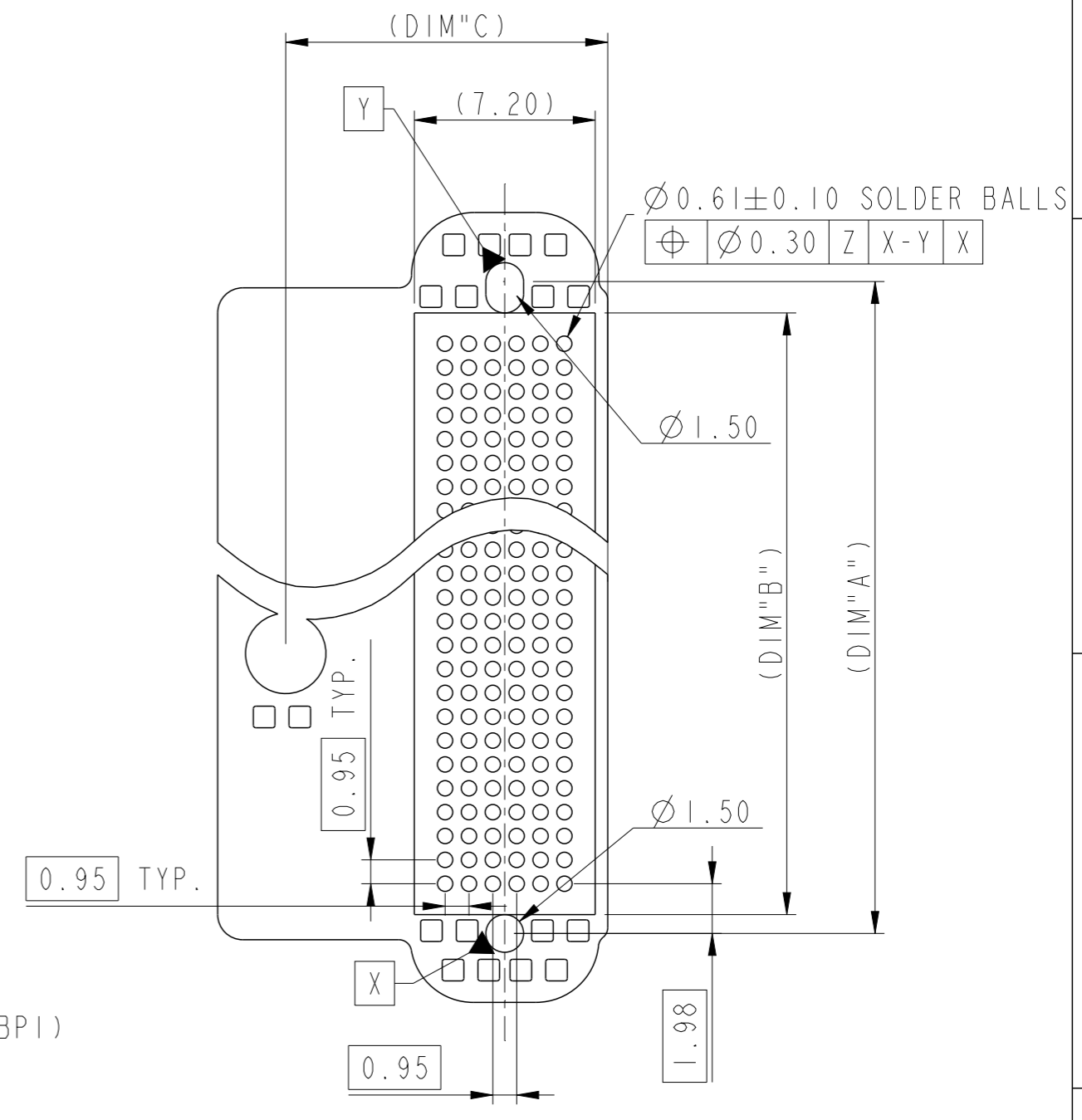
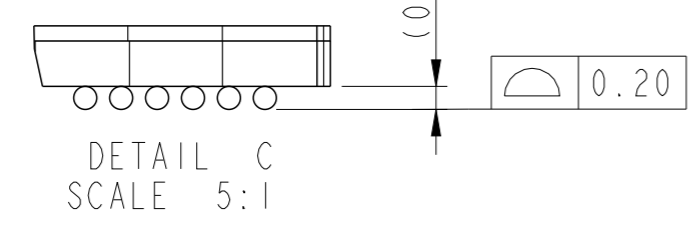
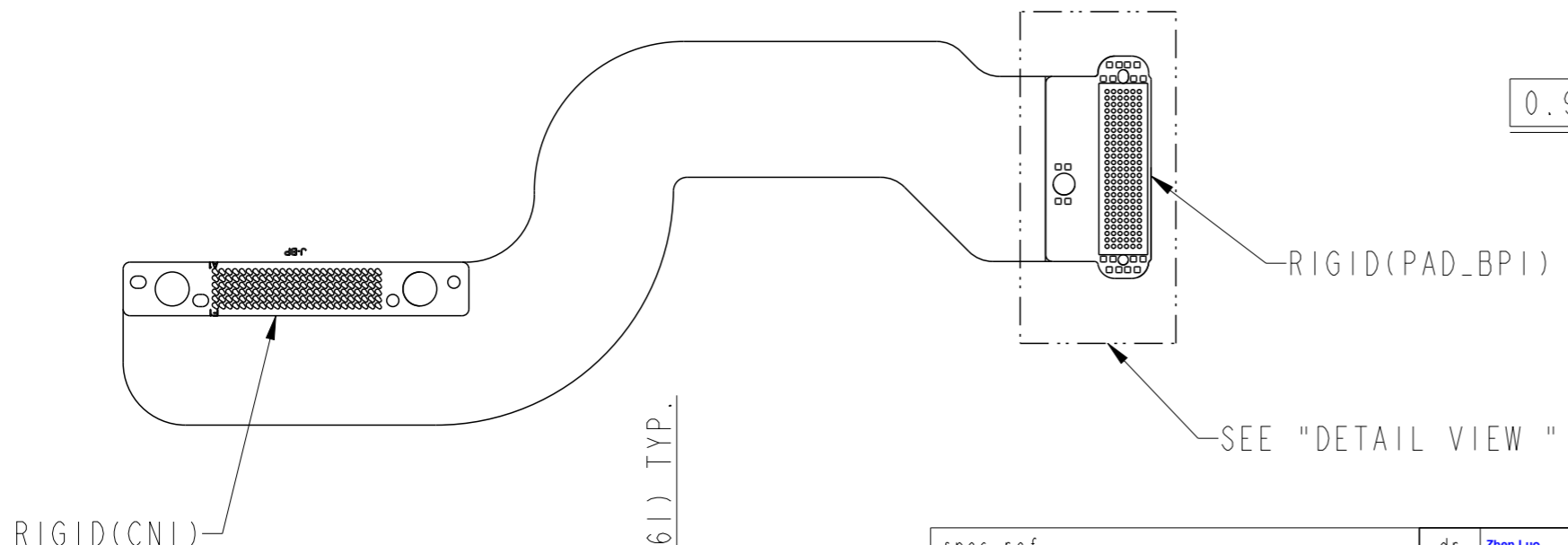
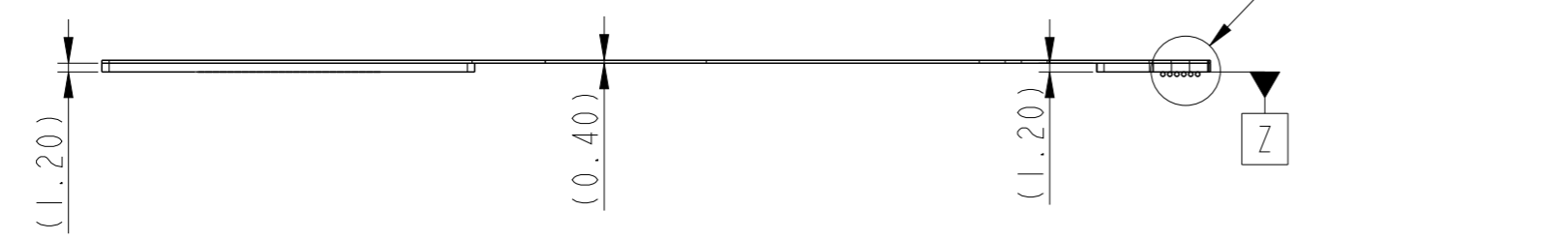
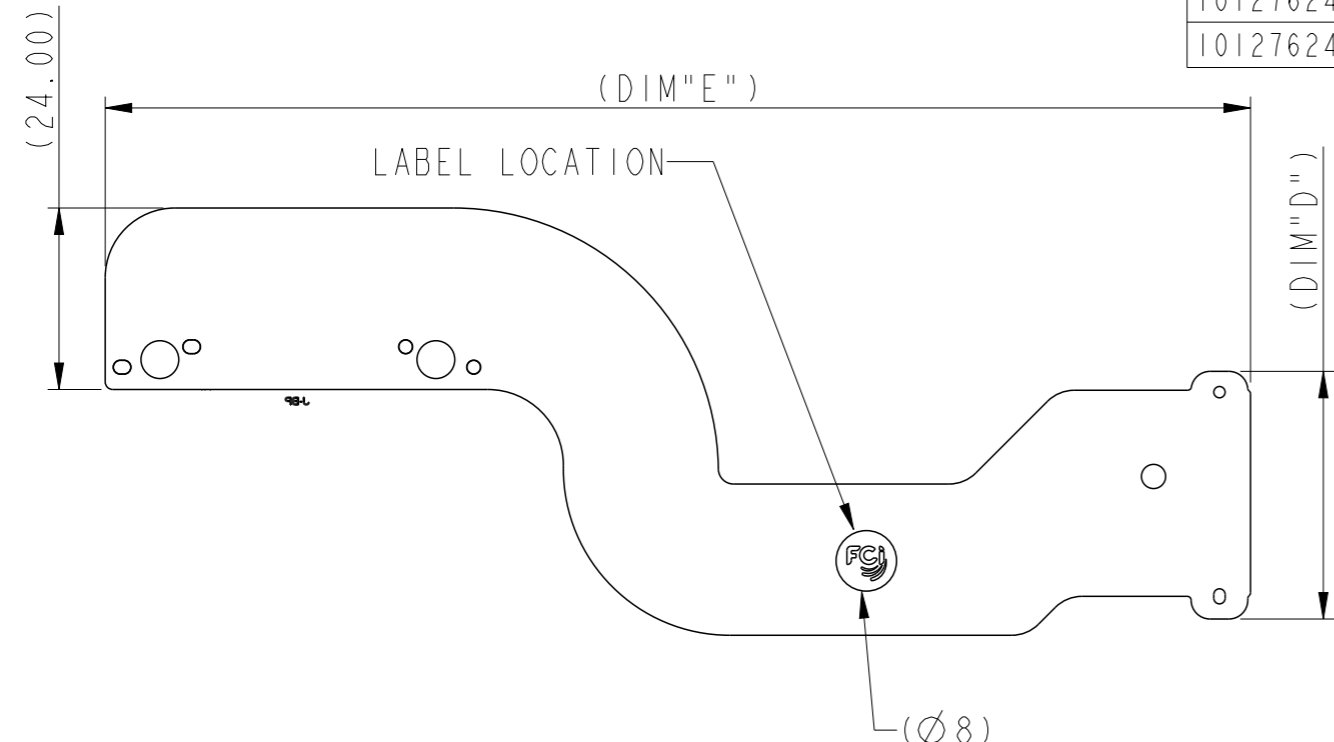

SCALE 4:1

spec ref	dr	Zhen Luo	2014/03/14	projection	MM	size	A3	scale	1:1
tolerance std	eng	Michael Song	2017/04/13			ecn no	ELX-DG-26616-1	rel level	Released
ASME Y14.5	chr	-	product family						
TOLERANCES UNLESS OTHERWISE SPECIFIED		Amphenol FCI		Flex Cable BGA		dwg no	10127624	rev	C
surface	linear	0.X	±0.30	www.fci.com	cat. no.	-	Product - Customer Drw	sheet 4 of 7	
		0.XX	±0.20						
		0.XXX	±0.10						
ASME Y14.5	angular	0°	±2°						

Product P/N	Flex Cable P/N In Wistron	BGA Array Pattern
10127624-13961XXLF	13961	6X25

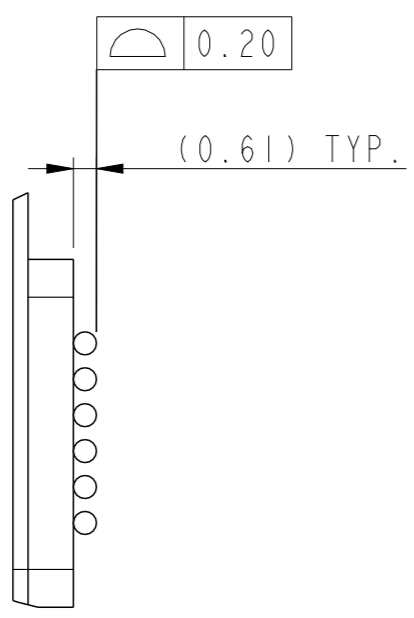
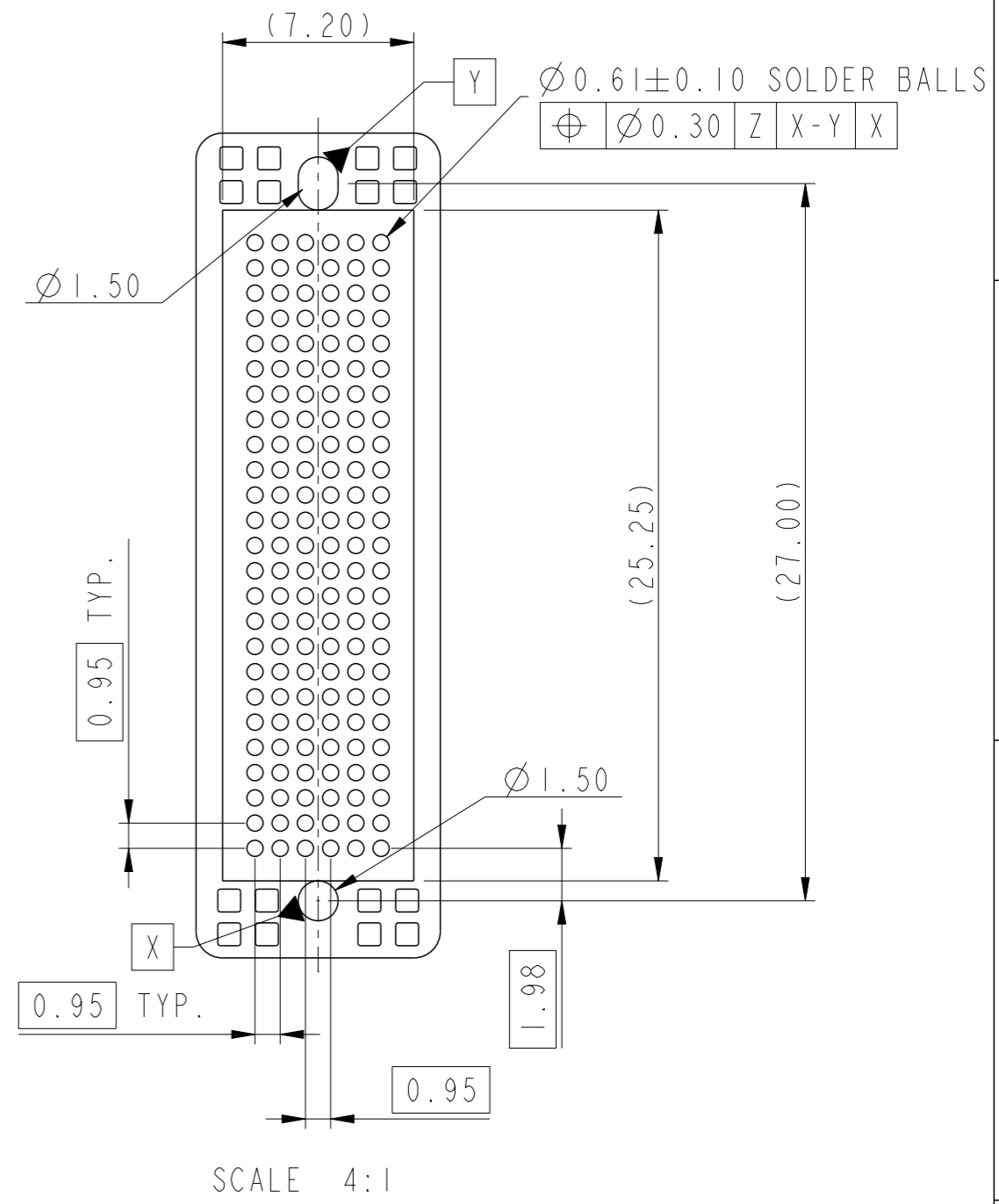
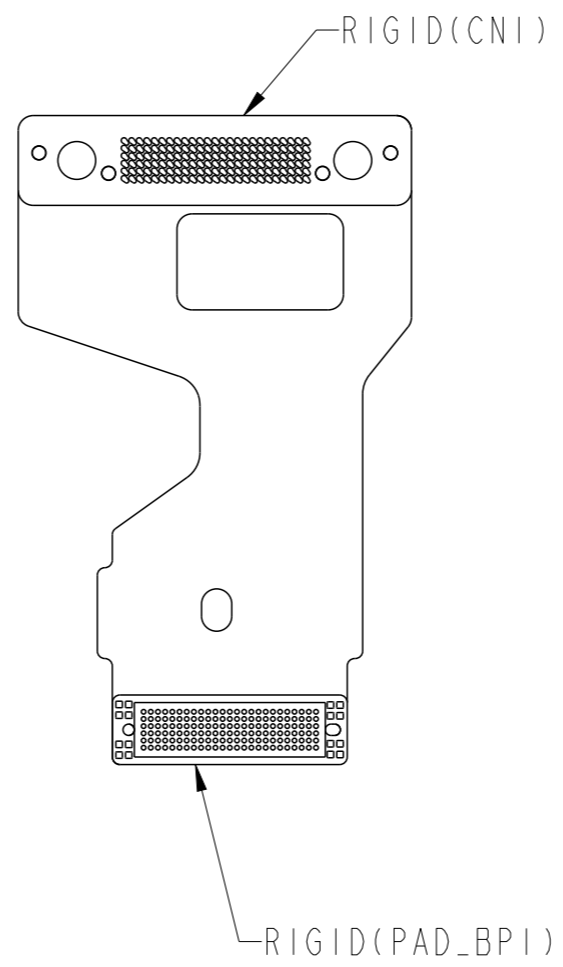
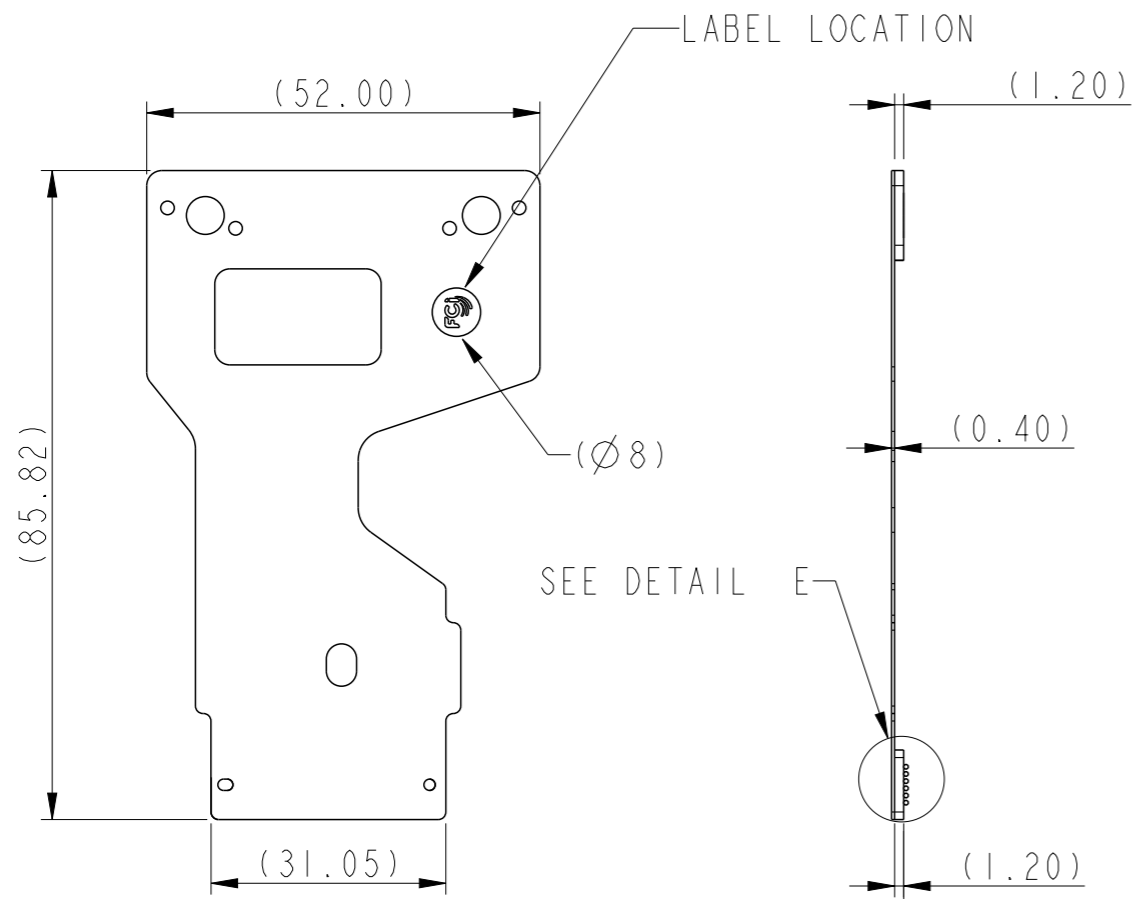

DETAIL E
SCALE 5:1

spec ref	dr	Zhen Luo	2014/03/14	projection	MM	size	A3	scale	1:1		
tolerance std	eng	Michael Song	2017/04/13			ecn no	ELX-DG-26616-1	rel level	Released		
ASME Y14.5	chr	-	-								
TOLERANCES UNLESS OTHERWISE SPECIFIED				product family	-						
surface	linear	0.X	±0.30	Amphenol FCI www.fci.com	title Flex Cable BGA cat. no. -	dwg no 10127624	rev C				
		0.XX	±0.20					Product - Customer Drw		sheet 5 of 7	
		0.XXX	±0.10								
ASME Y14.5	angular	0°	±2°								

Amphenol FCI

© 2016 AFCI

Product P/N	Flex Cable P/N In Wistron	BGA Array Pattern
10127624-13962XXLF	13962	6X17

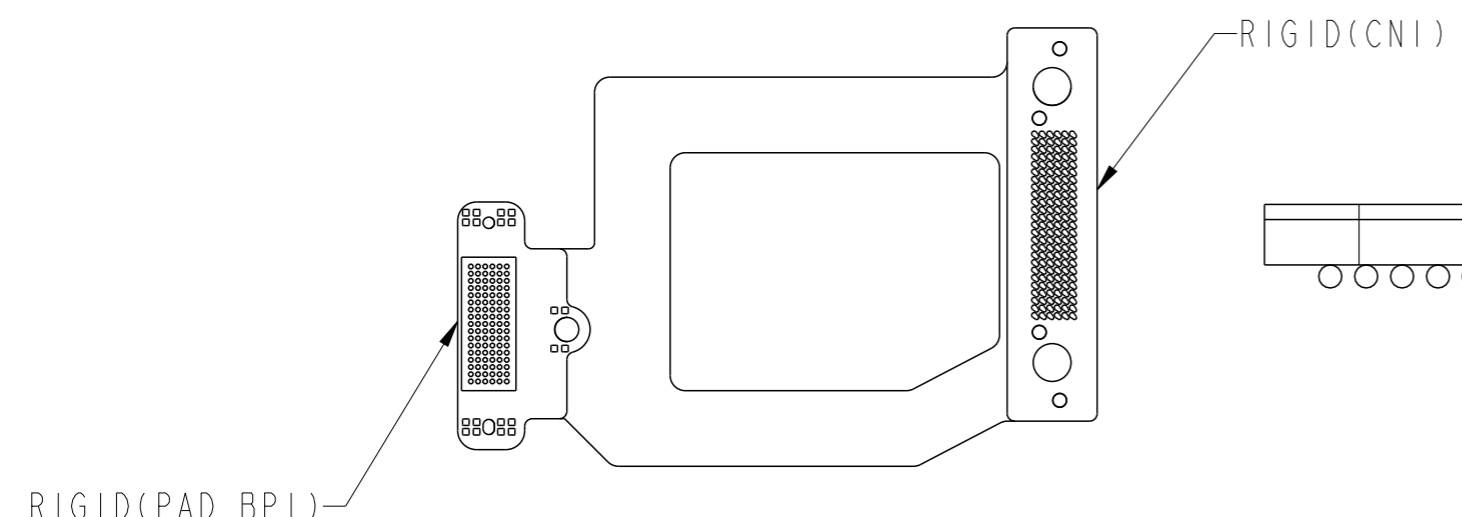
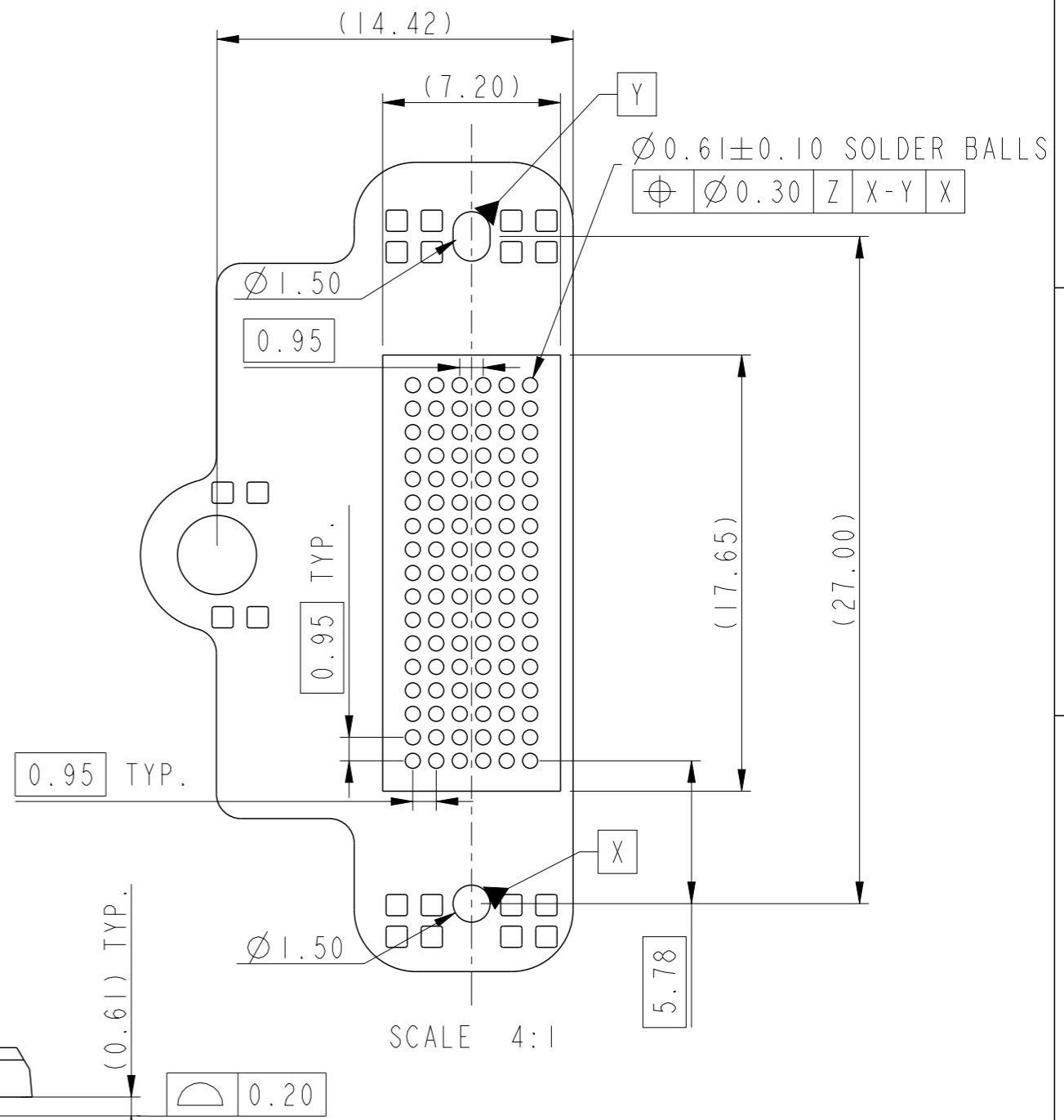
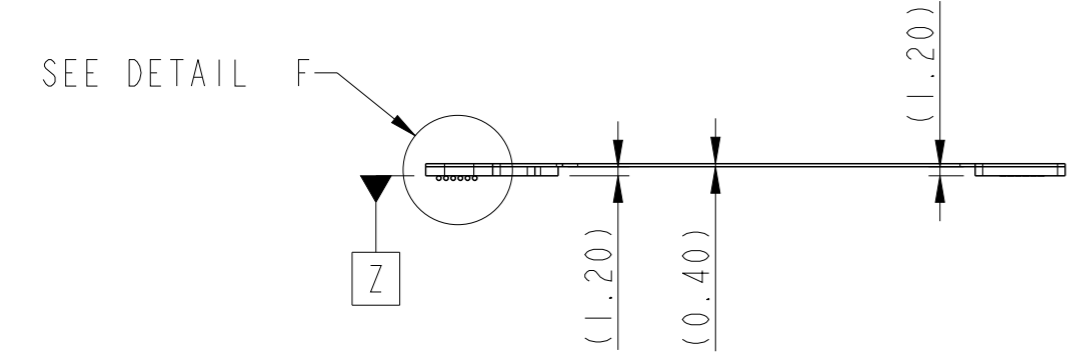
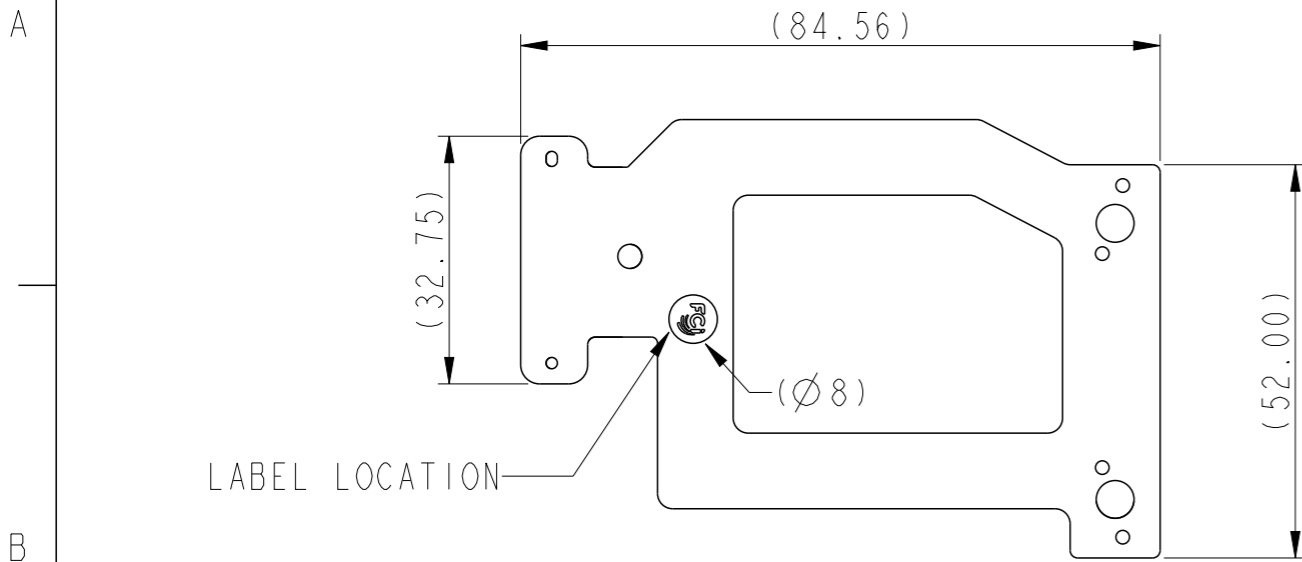

DETAIL F
SCALE 5:1

spec ref	dr	Zhen Luo	2014/03/14	projection	MM	size	A3	scale	1:1			
tolerance std	eng	Michael Song	2017/04/13			ecn no	ELX-DG-26616-1	rel level	Released			
ASME Y14.5	chr	-	-							product family	-	
TOLERANCES UNLESS OTHERWISE SPECIFIED		appr	Heaven Cen	2017/04/13	title		Flex Cable BGA		dwg no	10127624	rev	C
surface	linear	0.X	±0.30	www.fci.com		cat. no.	-	Product - Customer Drw		sheet 6 of 7		
		0.XX	±0.20									
		0.XXX	±0.10									
ASME Y14.5	angular	0°	±2°									

Amphenol
FCi

© 2016 AFCI

PRODUCT PART NUMBER

10127624-□□□□XXLF

BASE NUMBER

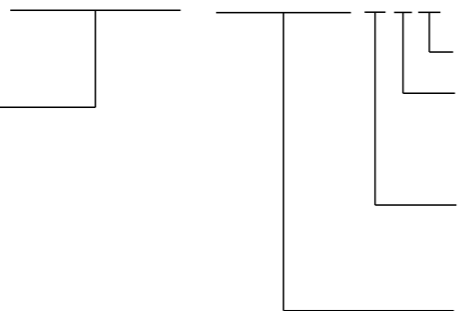

LEAD FREE
 PCB DESIGN:
 0: STANDARD
 I TO N: NEW STACKUP
 SUPPLIER:
 M: Multex
 T: TTM
 CODE (SEE TABLE)

- NOTES:
 1. MATERIAL:
 FLEX CABLE
 SOLDER BALL: LEAD FREE 96.5Sn/3Ag/0.5Cu
 2. SOLDER BALLS WILL NOT BE PERFECT SPHERICAL SHAPE DUE TO REFLOW ATTACHMENT.
 3. PRODUCT SPECIFICATION: GS-12-1183.
 4. APPLICATION SPECIFICATION: GS-20-0391.
 5. PACKAGE SPECIFICATION: GS-14-2365.
 6. PRODUCT MEET EUROPEAN UNION DIRECTIVES AND OTHER COUNTRY REGULATIONS DESCRIBED IN GS-22-08.

CODE	Flex Cable P/N In Wistron	DETAIL VIEW	CODE	Flex Cable P/N In Wistron	DETAIL VIEW	CODE	Flex Cable P/N In Wistron	DETAIL VIEW
13608	13608		13658	13658		13613	13613	
13609	13609		13612	13612		13615	13615	
13611	13611		13616	13616		13961	13961	
13614	13614		13610	13610		13962	13962	

Amphenol FCI © 2016 AFCI

spec ref	dr	Zhen Luo	2014/03/14	projection	MM	size	A3	scale	1:1
tolerance std	eng	Michael Song	2017/04/13		← →	ecn no	ELX-DG-26616-1		
ASME Y14.5	chr	-	-				rel level	Released	
surface	linear	0.X	±0.30	Amphenol FCI	Flex Cable BGA	dwg no	10127624		
		0.XX	±0.20						
		0.XXX	±0.10						
ASME Y14.5	angular	0°	±0°	www.fci.com	cat. no.	-	Product - Customer Drw	sheet 7 of 7	