

"High Frequency Ceramic Solutions"

898 MHz Mini Directional Coupler

P/N 0898CP14C0035

Detail Specification: 3/31/2016

Page 1 of 4

Not exactly what you are looking for and want to see our other couplers? Go to: www.johansontechnology.com/couplers

General Specifications

Part Number	0898CP14C0035	
Freq. Range (MHz)	880 ~ 915	
Insertion Loss (dB)	0.35 max.	
Return Loss (dB)	18.0 min.	
Coupling (dB)	17.0 ± 1.0	
Isolation (dB)	30.0 min.	Power Capacity 2W max.
Storage Conditions	+5 ~ +35°C, Humidity 45~75%	Operating Temp Range -40 to +85°C
Storage Period	18 months max.	Quantity/Reel 4000

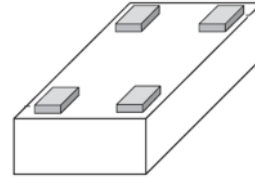

Mechanical Dimensions

	In	mm
L	0.063 ± 0.004	1.60 ± 0.10
W	0.033 ± 0.004	0.84 ± 0.10
T	0.024 ± 0.004	0.60 ± 0.10
A	0.010 ± 0.002	0.25 ± 0.05
B	0.008 ± 0.002	0.20 ± 0.05
S	0.002 ± 0.002	0.05 ± 0.05

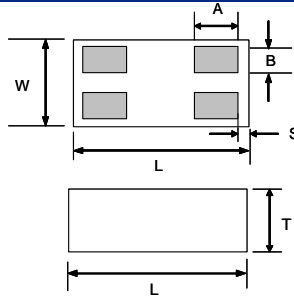

Terminal Configuration

1	IN	3	Terminated
2	OUT	4	COUPLED OUT

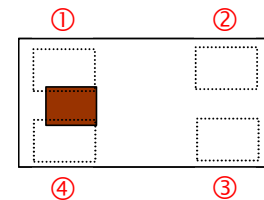

Always mount this component with red mark facing up. It will not function properly if flipped upside down.

Part Number Explanation

P/N Suffix	Packing Style	Bulk	Suffix = S	e.g.. 0898CP14C0035S
		T & R	Suffix = E	e.g.. 0898CP14C0035T
	Termination style	100% Tin	Suffix = None	e.g.. 0898CP14C0035(T or S)
	Evaluation Board	0898CP14C0035-EB1SMA		

Mounting Considerations

Units in mm

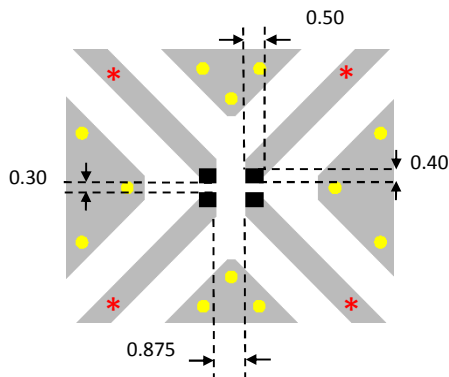

- Solder Resist
- Land
- Through-hole ($\phi 0.3$)

* Line width should be designed to match a 50Ω characteristic impedance (preferably Grounded CPW), depending on PCB material and thickness.

Always mount this component with red mark facing up. It will not function properly if flipped upside down

Need the layout file of the above? Send us a message at: <http://www.johansontechnology.com/ask-a-question>



www.johansontechnology.com

4001 Calle Tecate • Camarillo, CA 93012 • TEL 805.389.1166 FAX 805.389.1821

Ver. 1.0

2016 Johanson Technology, Inc. All Rights Reserved

"High Frequency Ceramic Solutions"

898 MHz Mini Directional Coupler

P/N 0898CP14C0035

Detail Specification: 3/31/2016

Page 2 of 4

Measurement Diagram and Setup

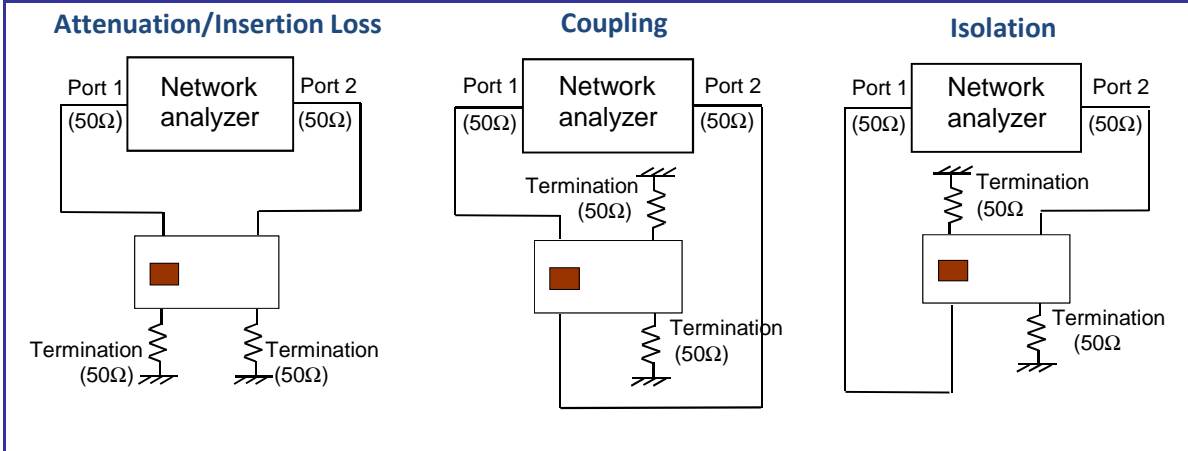

Typical Electrical Characteristics (T=25 °C)

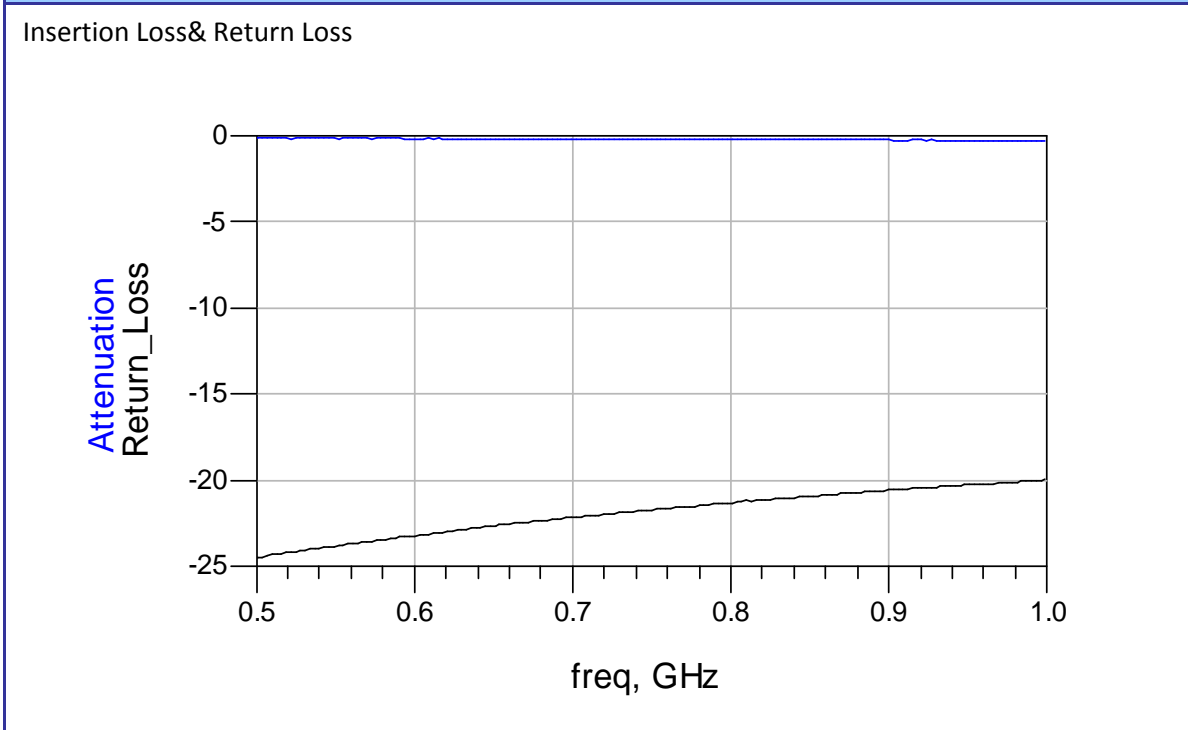

The contents of this data sheet are subject to change without notice. Please confirm the specifications and delivery conditions when placing your order. All sales are subject to Johanson Technology, Inc. terms and conditions.



"High Frequency Ceramic Solutions"

898 MHz Mini Directional Coupler

P/N 0898CP14C0035

Detail Specification: 3/31/2016

Page 3 of 4

Typical Electrical Characteristics (T=25 °C)

Coupling & Isolation

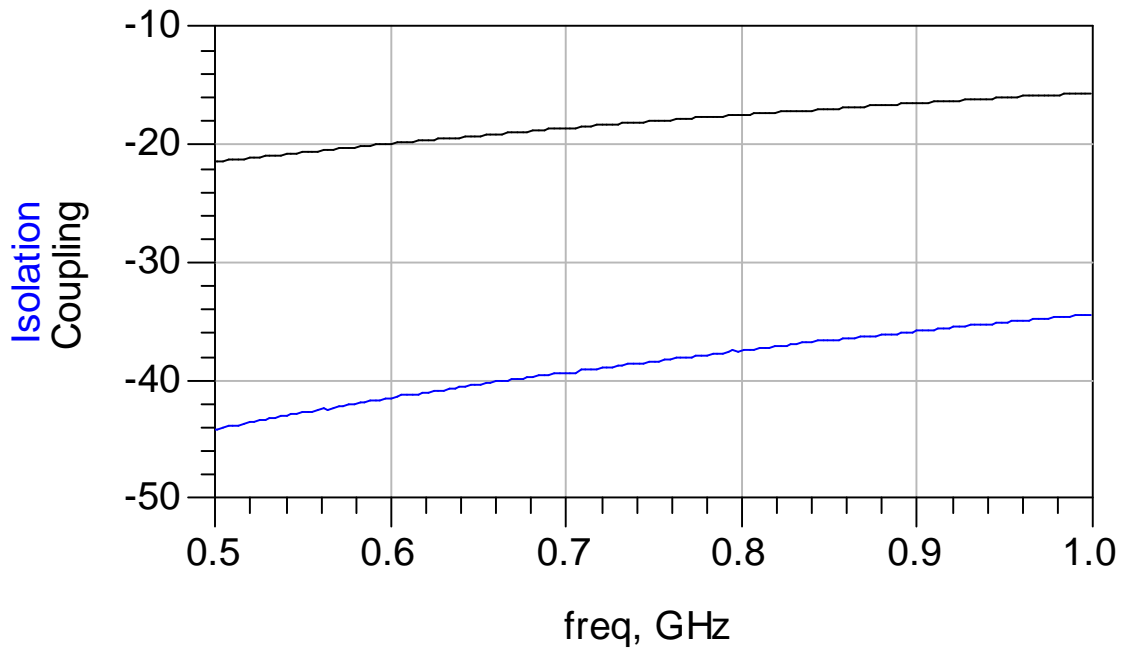

The contents of this data sheet are subject to change without notice. Please confirm the specifications and delivery conditions when placing your order. All sales are subject to Johanson Technology, Inc. terms and conditions.



www.johansontechnology.com
4001 Calle Tecate • Camarillo, CA 93012 • TEL 805.389.1166 FAX 805.389.1821
Ver. 1.0

2016 Johanson Technology, Inc. All Rights Reserved

"High Frequency Ceramic Solutions"

898 MHz Mini Directional Coupler

P/N 0898CP14C0035

Detail Specification: 3/31/2016

Page 4 of 4

RoHS Compliance

www.johansontechnology.com/rohs-compliance

Packaging information

www.johansontechnology.com/tape-reel-packaging

Soldering Information

www.johansontechnology.com/ipcsoldering-profile

Layout Files, s-parameters and any other technical questions

www.johansontechnology.com/ask-a-question

MSL Info

www.johansontechnology.com/msl-rating

Recommended Storage Condition and Max Shelf Life

www.johansontechnology.com/recommended-storage-conditions

Need a small SMD chip Antenna?

www.johansontechnology.com/antennas

Antenna layout and tuning techniques

www.johansontechnology.com/tuning

Antenna layout review, tuning, and characterization services

www.johansontechnology.com/ipc-antenna-services

The contents of this data sheet are subject to change without notice. Please confirm the specifications and delivery conditions when placing your order. All sales are subject to Johanson Technology, Inc. terms and conditions.



www.johansontechnology.com
4001 Calle Tecate • Camarillo, CA 93012 • TEL 805.389.1166 FAX 805.389.1821
Ver. 1.0

2016 Johanson Technology, Inc. All Rights Reserved