

# AFE4405 Ultra-Small, Integrated AFE with FIFO for Wearable, Optical Heart-Rate Monitoring and Bio-Sensing

## 1 Features

- Transmitter:
  - Supports Common Anode LED Configuration
  - Dynamic Range: 100 dB
  - 8-Bit Programmable LED Current to 50 mA (Extendable to 100 mA)
  - Programmable LED On-Time
  - Simultaneous Support of 3 LEDs for Optimized SpO<sub>2</sub>, HRM, or Multi-Wavelength HRM
- Receiver:
  - Supports 2 Time-Multiplexed Photodiode Inputs
  - 24-Bit Representation of the Current Input from the Photodiode in Twos Complement Format
  - Individual DC Offset Subtraction DAC ( $\pm 15.75\text{-}\mu\text{A}$  Range) at TIA Input for Each LED, Ambient
  - Digital Ambient Subtraction at ADC Output
  - Transimpedance Gain: 10 k $\Omega$  to 2 M $\Omega$
  - Dynamic Range: 100 dB
  - Dynamic Power-Saving Mode to Reduce Receiver Current to 200  $\mu\text{A}$
- Pulse Frequency: 5 SPS to 1000 SPS
- Flexible Pulse Sequencing and Timing Control
- Flexible Clock Options:
  - External Clocking: 4-MHz to 60-MHz Input Clock
  - Internal Clocking: 4-MHz Oscillator
- FIFO with 240 Sample Depth:
  - Programmable Partitioning Across Phases
- I<sup>2</sup>C, SPI Interfaces: Selectable by Pin
- Operating Temperature Range:  $-20^{\circ}\text{C}$  to  $+70^{\circ}\text{C}$
- 2.6-mm  $\times$  2.1-mm DSBGA, 0.4-mm Pitch
- Supplies: Rx: 2 V to 3.6 V, Tx: 3 V to 5.25 V, IO: 1.8 V to 3.6 V

## 2 Applications

- Optical Heart-Rate Monitoring (HRM) for Wearables, Hearables
- Heart-Rate Variability (HRV)
- Pulse Oximetry (SpO<sub>2</sub>) Measurements
- Maximum Oxygen Consumption (VO<sub>2</sub> Max)
- Calorie Expenditure

## 3 Description

The AFE4405 is an analog front-end (AFE) for optical bio-sensing applications, such as heart-rate monitoring (HRM) and saturation of peripheral capillary oxygen (SpO<sub>2</sub>). The device supports three switching light-emitting diodes (LEDs) and up to two photodiodes. The current from the photodiode is converted into voltage by the transimpedance amplifier (TIA) and digitized using an analog-to-digital converter (ADC). The ADC code can be stored in a 240-sample first in, first out (FIFO) block with programmable depth. The FIFO depth can be partitioned to accommodate the phases that must be stored. The FIFO can be read out using either an I<sup>2</sup>C or a SPI interface. The AFE also has a fully-integrated LED driver with an 8-bit current control. The device has a high dynamic range transmit-and-receive circuitry that helps with the sensing of very small signal levels.

To request a full data sheet or other design resources: [request AFE4405](#)

### Device Information<sup>(1)</sup>

| PART NUMBER | PACKAGE    | BODY SIZE (NOM)          |
|-------------|------------|--------------------------|
| AFE4405     | DSBGA (30) | 2.60 mm $\times$ 2.10 mm |

(1) For all available packages, see the orderable addendum at the end of the datasheet.

### Simplified Block Diagram

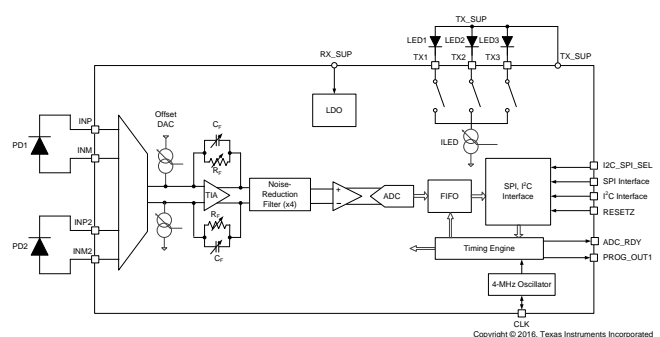

## 4 Revision History

NOTE: Page numbers for previous revisions may differ from page numbers in the current version.

| <b>Changes from Revision B (May 2016) to Revision C</b> | <b>Page</b> |
|---|-------------|
|---|-------------|

- |  |   |
|--|---|
| • Changed the <i>Mechanical Packaging</i> images ..... | 4 |
|--|---|

| <b>Changes from Revision A (May 2016) to Revision B</b> | <b>Page</b> |
|---|-------------|
|---|-------------|

- |   |   |
|---|---|
| • Added link to request full data sheet ..... | 1 |
|---|---|

| <b>Changes from Original (April 2016) to Revision A</b> | <b>Page</b> |
|---|-------------|
|---|-------------|

- |                               |   |
|-------------------------------|---|
| • Released to production..... | 1 |
|-------------------------------|---|

## 5 Device and Documentation Support

### 5.1 Receiving Notification of Documentation Updates

To receive notification of documentation updates, navigate to the device product folder on ti.com. In the upper right corner, click on *Alert me* to register and receive a weekly digest of any product information that has changed. For change details, review the revision history included in any revised document.

### 5.2 Community Resources

The following links connect to TI community resources. Linked contents are provided "AS IS" by the respective contributors. They do not constitute TI specifications and do not necessarily reflect TI's views; see TI's [Terms of Use](#).

**TI E2E™ Online Community** *TI's Engineer-to-Engineer (E2E) Community*. Created to foster collaboration among engineers. At e2e.ti.com, you can ask questions, share knowledge, explore ideas and help solve problems with fellow engineers.

**Design Support** *TI's Design Support* Quickly find helpful E2E forums along with design support tools and contact information for technical support.

### 5.3 Trademarks

E2E is a trademark of Texas Instruments.  
All other trademarks are the property of their respective owners.

### 5.4 Electrostatic Discharge Caution



This integrated circuit can be damaged by ESD. Texas Instruments recommends that all integrated circuits be handled with appropriate precautions. Failure to observe proper handling and installation procedures can cause damage.

ESD damage can range from subtle performance degradation to complete device failure. Precision integrated circuits may be more susceptible to damage because very small parametric changes could cause the device not to meet its published specifications.

### 5.5 Glossary

[SLYZ022](#) — *TI Glossary*.

This glossary lists and explains terms, acronyms, and definitions.

## 6 Mechanical, Packaging, and Orderable Information

The following pages include mechanical, packaging, and orderable information. This information is the most current data available for the designated devices. This data is subject to change without notice and revision of this document. For browser-based versions of this data sheet, refer to the left-hand navigation.

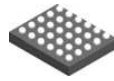

YZ0030-C01

PACKAGE OUTLINE  
DSBGA - 0.5 mm max height

DIE SIZE BALL GRID ARRAY

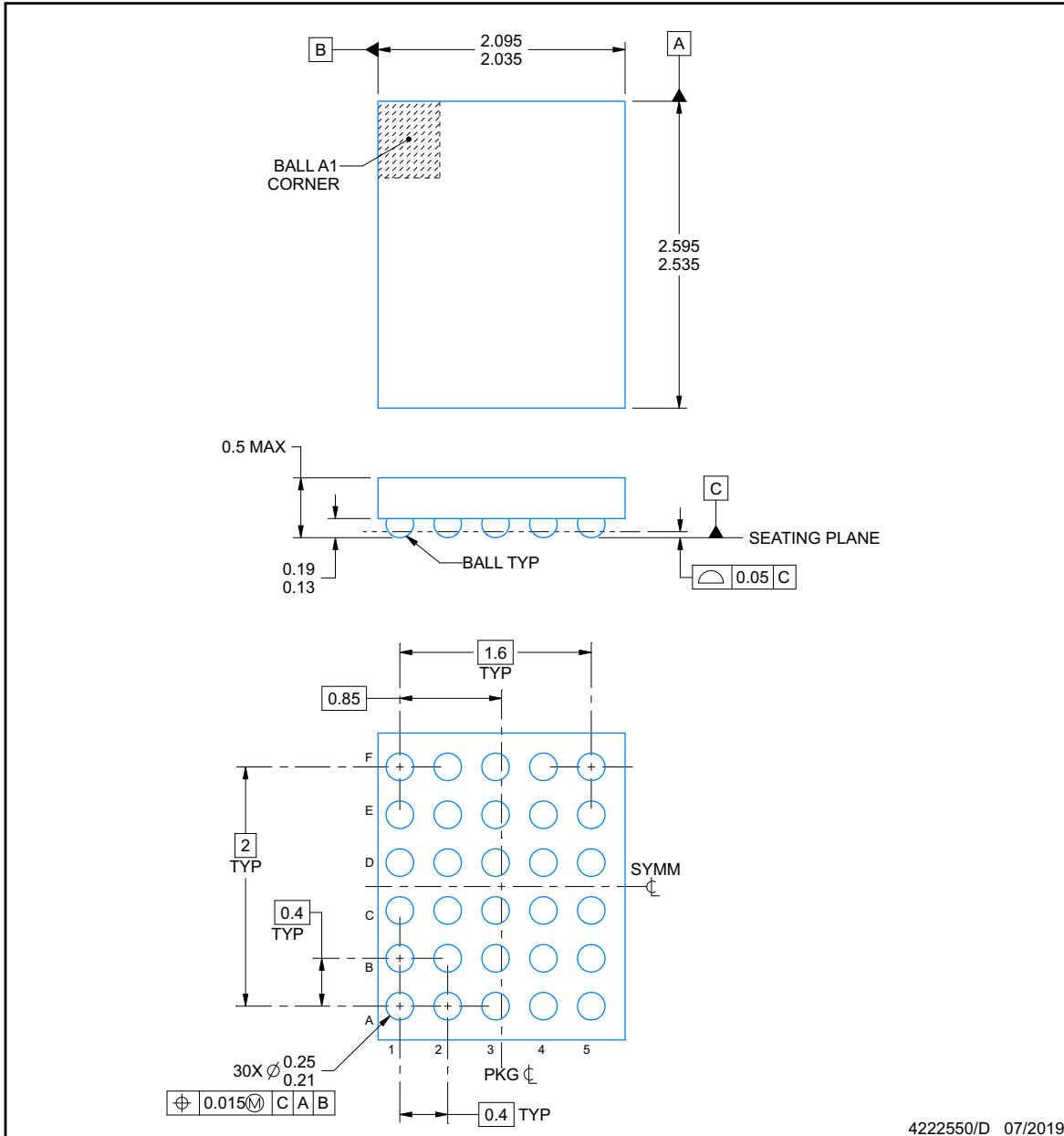

NOTES:

1. All linear dimensions are in millimeters. Any dimensions in parenthesis are for reference only. Dimensioning and tolerancing per ASME Y14.5M.
2. This drawing is subject to change without notice.

## EXAMPLE BOARD LAYOUT

**YZ0030-C01**

**DSBGA - 0.5 mm max height**

DIE SIZE BALL GRID ARRAY

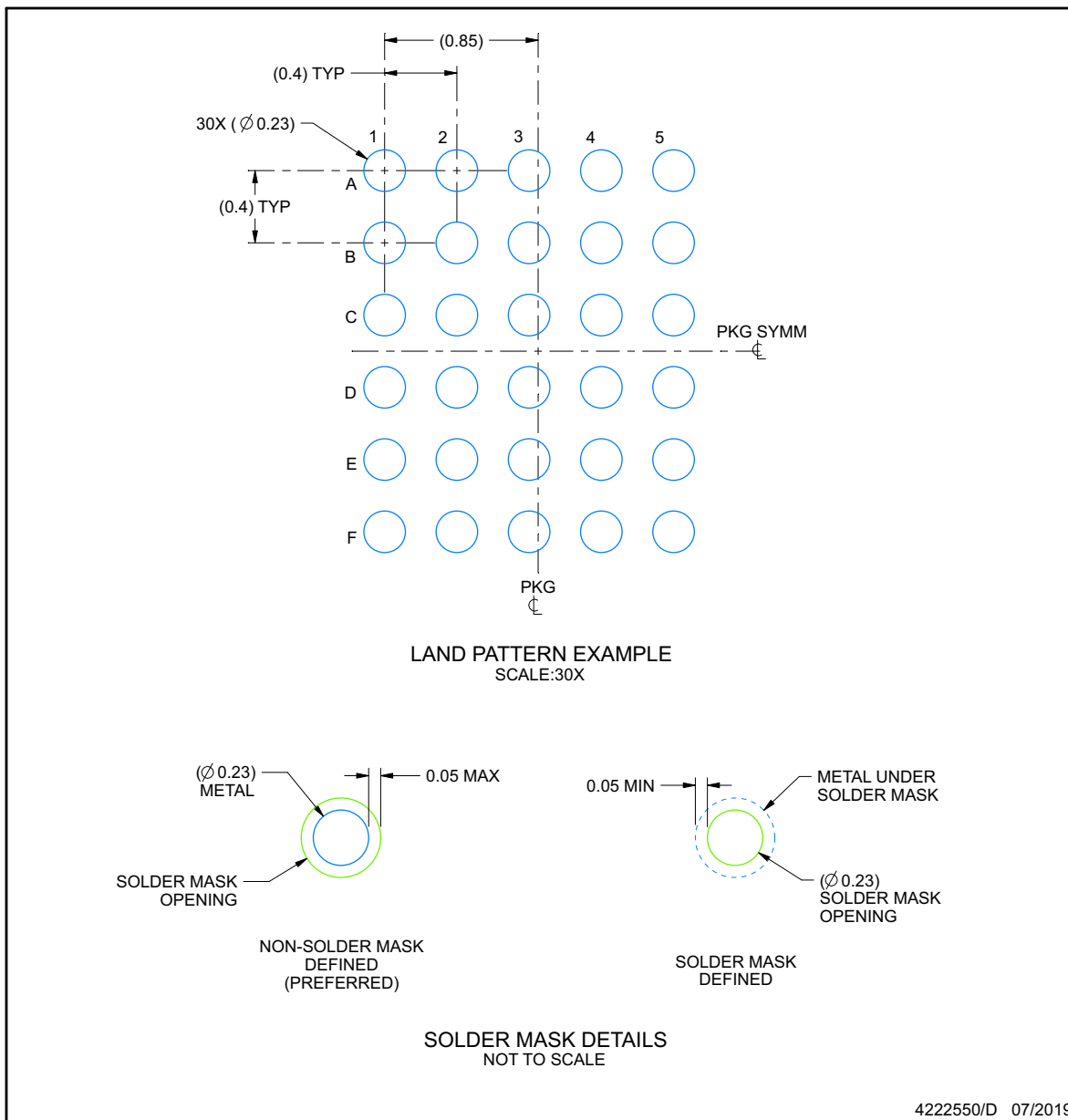

NOTES: (continued)

- Final dimensions may vary due to manufacturing tolerance considerations and also routing constraints. See Texas Instruments Literature No. SNVA009 ([www.ti.com/lit/snva009](http://www.ti.com/lit/snva009)).

**EXAMPLE STENCIL DESIGN**

**YZ0030-C01**

**DSBGA - 0.5 mm max height**

DIE SIZE BALL GRID ARRAY

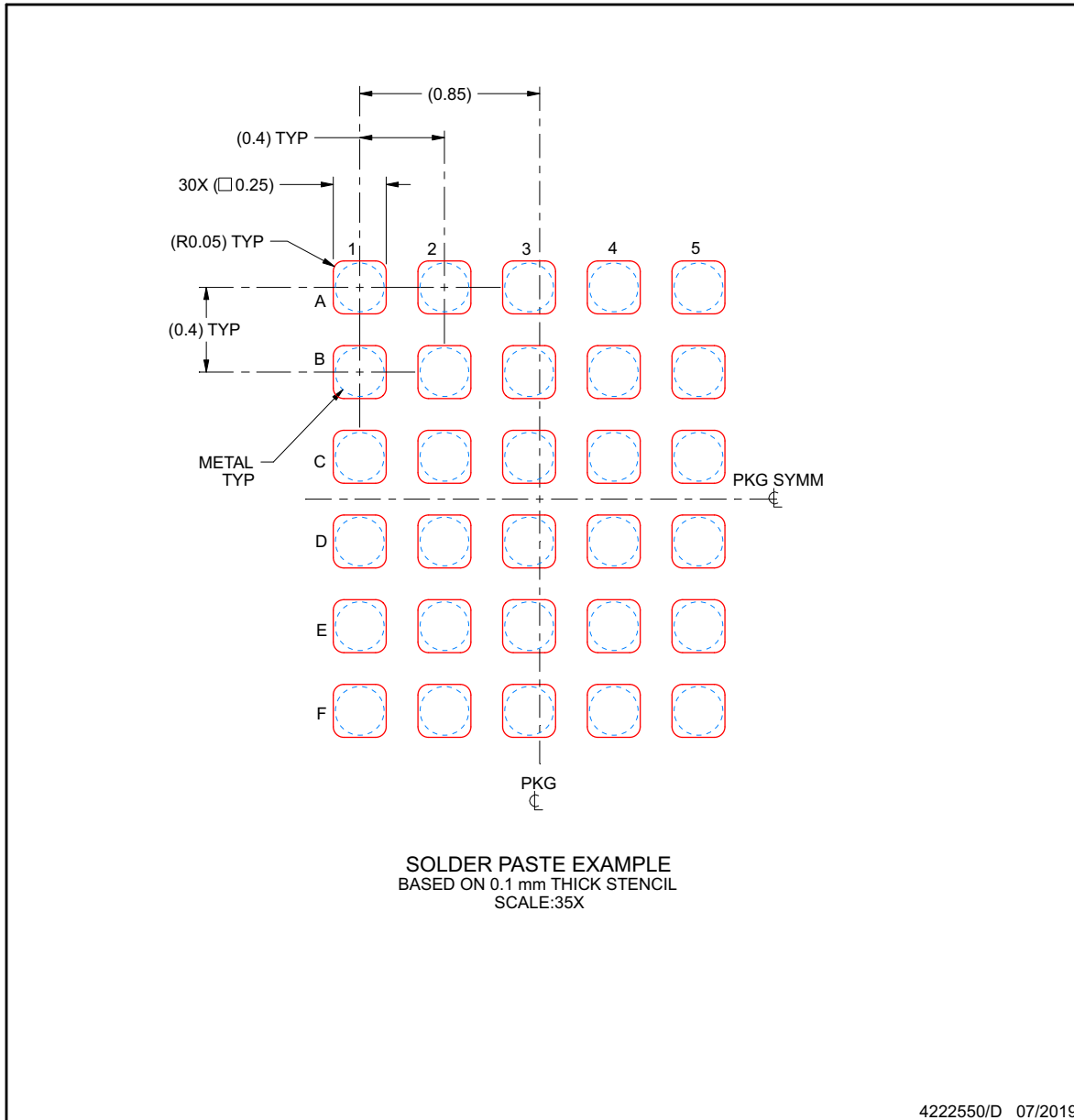

NOTES: (continued)

- 4. Laser cutting apertures with trapezoidal walls and rounded corners may offer better paste release.

## PACKAGING INFORMATION

| Orderable Device | Status<br>(1) | Package Type | Package<br>Drawing | Pins | Package<br>Qty | Eco Plan<br>(2) | Lead finish/<br>Ball material<br>(6) | MSL Peak Temp<br>(3) | Op Temp (°C) | Device Marking<br>(4/5) | Samples        |
|------------------|---------------|--------------|--------------------|------|----------------|-----------------|--------------------------------------|----------------------|--------------|-------------------------|----------------|
| AFE4405YZR       | ACTIVE        | DSBGA        | YZ                 | 30   | 3000           | RoHS & Green    | SNAGCU                               | Level-1-260C-UNLIM   | -20 to 70    | AFE4405                 | <b>Samples</b> |

(1) The marketing status values are defined as follows:

**ACTIVE:** Product device recommended for new designs.

**LIFEBUY:** TI has announced that the device will be discontinued, and a lifetime-buy period is in effect.

**NRND:** Not recommended for new designs. Device is in production to support existing customers, but TI does not recommend using this part in a new design.

**PREVIEW:** Device has been announced but is not in production. Samples may or may not be available.

**OBSOLETE:** TI has discontinued the production of the device.

(2) **RoHS:** TI defines "RoHS" to mean semiconductor products that are compliant with the current EU RoHS requirements for all 10 RoHS substances, including the requirement that RoHS substance do not exceed 0.1% by weight in homogeneous materials. Where designed to be soldered at high temperatures, "RoHS" products are suitable for use in specified lead-free processes. TI may reference these types of products as "Pb-Free".

**RoHS Exempt:** TI defines "RoHS Exempt" to mean products that contain lead but are compliant with EU RoHS pursuant to a specific EU RoHS exemption.

**Green:** TI defines "Green" to mean the content of Chlorine (Cl) and Bromine (Br) based flame retardants meet JS709B low halogen requirements of <=1000ppm threshold. Antimony trioxide based flame retardants must also meet the <=1000ppm threshold requirement.

(3) MSL, Peak Temp. - The Moisture Sensitivity Level rating according to the JEDEC industry standard classifications, and peak solder temperature.

(4) There may be additional marking, which relates to the logo, the lot trace code information, or the environmental category on the device.

(5) Multiple Device Markings will be inside parentheses. Only one Device Marking contained in parentheses and separated by a "-" will appear on a device. If a line is indented then it is a continuation of the previous line and the two combined represent the entire Device Marking for that device.

(6) Lead finish/Ball material - Orderable Devices may have multiple material finish options. Finish options are separated by a vertical ruled line. Lead finish/Ball material values may wrap to two lines if the finish value exceeds the maximum column width.

**Important Information and Disclaimer:** The information provided on this page represents TI's knowledge and belief as of the date that it is provided. TI bases its knowledge and belief on information provided by third parties, and makes no representation or warranty as to the accuracy of such information. Efforts are underway to better integrate information from third parties. TI has taken and continues to take reasonable steps to provide representative and accurate information but may not have conducted destructive testing or chemical analysis on incoming materials and chemicals. TI and TI suppliers consider certain information to be proprietary, and thus CAS numbers and other limited information may not be available for release.

In no event shall TI's liability arising out of such information exceed the total purchase price of the TI part(s) at issue in this document sold by TI to Customer on an annual basis.

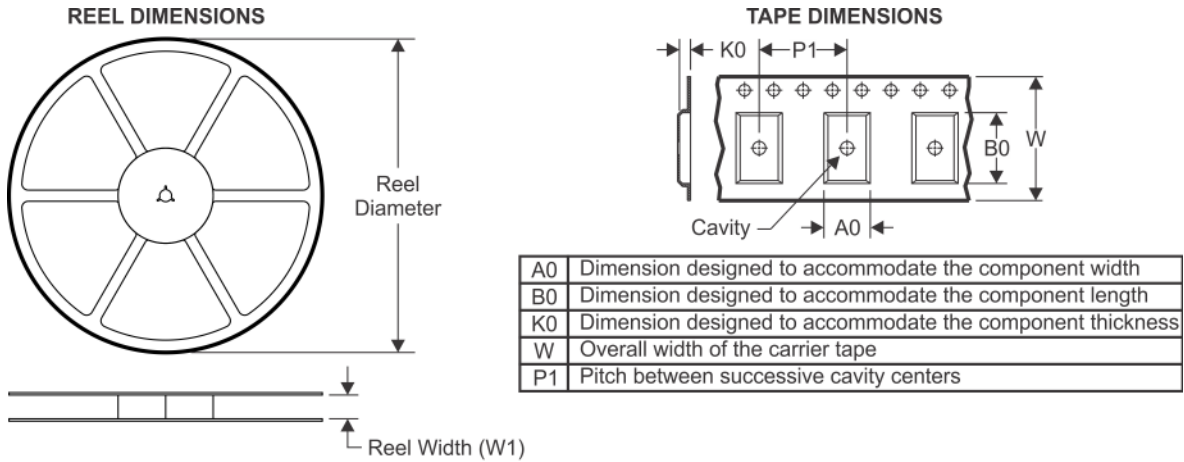
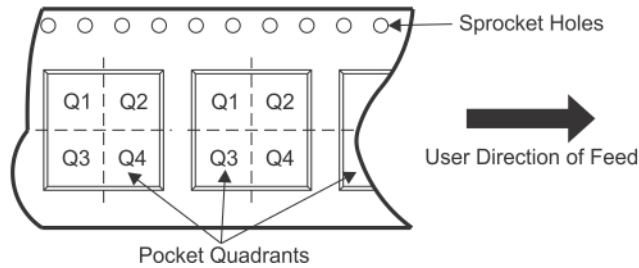
**TAPE AND REEL INFORMATION**

**QUADRANT ASSIGNMENTS FOR PIN 1 ORIENTATION IN TAPE**

\*All dimensions are nominal

| Device     | Package Type | Package Drawing | Pins | SPQ  | Reel Diameter (mm) | Reel Width W1 (mm) | A0 (mm) | B0 (mm) | K0 (mm) | P1 (mm) | W (mm) | Pin1 Quadrant |
|------------|--------------|-----------------|------|------|--------------------|--------------------|---------|---------|---------|---------|--------|---------------|
| AFE4405YZR | DSBGA        | YZ              | 30   | 3000 | 180.0              | 8.4                | 2.16    | 2.66    | 0.6     | 4.0     | 8.0    | Q1            |

**TAPE AND REEL BOX DIMENSIONS**



\*All dimensions are nominal

| Device     | Package Type | Package Drawing | Pins | SPQ  | Length (mm) | Width (mm) | Height (mm) |
|------------|--------------|-----------------|------|------|-------------|------------|-------------|
| AFE4405YZR | DSBGA        | YZ              | 30   | 3000 | 210.0       | 185.0      | 35.0        |

## IMPORTANT NOTICE AND DISCLAIMER

TI PROVIDES TECHNICAL AND RELIABILITY DATA (INCLUDING DATASHEETS), DESIGN RESOURCES (INCLUDING REFERENCE DESIGNS), APPLICATION OR OTHER DESIGN ADVICE, WEB TOOLS, SAFETY INFORMATION, AND OTHER RESOURCES "AS IS" AND WITH ALL FAULTS, AND DISCLAIMS ALL WARRANTIES, EXPRESS AND IMPLIED, INCLUDING WITHOUT LIMITATION ANY IMPLIED WARRANTIES OF MERCHANTABILITY, FITNESS FOR A PARTICULAR PURPOSE OR NON-INFRINGEMENT OF THIRD PARTY INTELLECTUAL PROPERTY RIGHTS.

These resources are intended for skilled developers designing with TI products. You are solely responsible for (1) selecting the appropriate TI products for your application, (2) designing, validating and testing your application, and (3) ensuring your application meets applicable standards, and any other safety, security, or other requirements. These resources are subject to change without notice. TI grants you permission to use these resources only for development of an application that uses the TI products described in the resource. Other reproduction and display of these resources is prohibited. No license is granted to any other TI intellectual property right or to any third party intellectual property right. TI disclaims responsibility for, and you will fully indemnify TI and its representatives against, any claims, damages, costs, losses, and liabilities arising out of your use of these resources.

TI's products are provided subject to TI's Terms of Sale ([www.ti.com/legal/termsofsale.html](http://www.ti.com/legal/termsofsale.html)) or other applicable terms available either on [ti.com](http://ti.com) or provided in conjunction with such TI products. TI's provision of these resources does not expand or otherwise alter TI's applicable warranties or warranty disclaimers for TI products.

Mailing Address: Texas Instruments, Post Office Box 655303, Dallas, Texas 75265  
Copyright © 2020, Texas Instruments Incorporated