

## MMBT2222A-HF (NPN)

RoHS Device  
Halogen Free

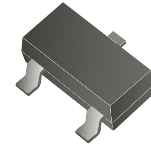

### Features

- Epoxy meets UL-94 V-0 flammability rating.
- Moisture sensitivity Level 1.
- High conductance.
- Surface mount package ideally suited for automatic insertion.

### Mechanical data

- Case: SOT-23, molded plastic.
- Terminals: Tin plated leads, solderable per J-STD-002 and JESD22-B102.

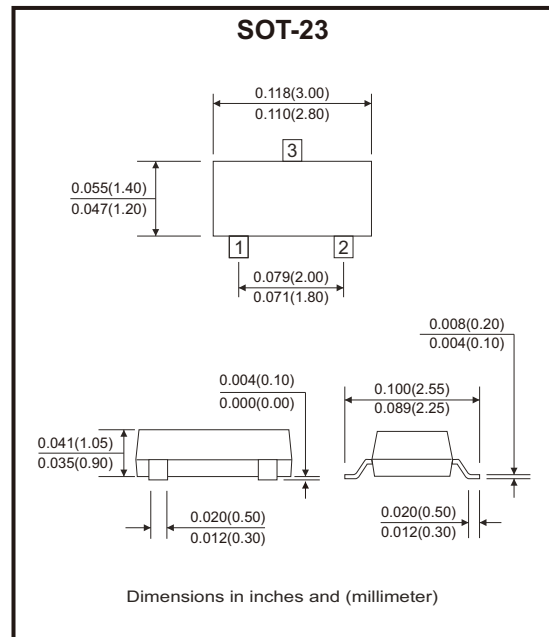

### Circuit Diagram

- 1. Base
- 2. Emitter
- 3. Collector

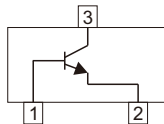

### Maximum Ratings (at Ta=25°C unless otherwise noted)

Parameter	Symbol	Value	Unit
Collector-base voltage	$V_{CBO}$	75	V
Collector-emitter voltage	$V_{CEO}$	40	V
Emitter-base voltage	$V_{EBO}$	6	V
Collector current	$I_C$	600	mA
Collector power dissipation	$P_C$	300	mW
Thermal resistance from junction to ambient	$R_{\theta JA}$	417	°C/W
Junction temperature	$T_J$	150	°C
Storage temperature range	$T_{STG}$	-55 to +150	°C

## Electrical Characteristics (at Ta=25°C unless otherwise noted)

Parameter	Conditions	Symbol	Min	Max	Unit
Collector-base breakdown voltage	$I_C = 10\mu A, I_E = 0$	$V_{CBO}$	75		V
Collector-emitter breakdown voltage	$I_C = 10mA, I_B = 0$	$V_{CEO}$	40		V
Emitter-base breakdown voltage	$I_E = 10\mu A, I_C = 0$	$V_{EBO}$	6		V
Collector-emitter cut-off current	$V_{CE} = 60V, V_{EB} = 3V$	$I_{CEX}$		10	nA
Collector-base cut-off current	$V_{CB} = 60V, I_E = 0$	$I_{CBO}$		100	nA
Emitter-base cut-off current	$V_{EB} = 3V, I_C = 0$	$I_{EBO}$		100	nA
DC current gain	$V_{CE} = 10V, I_C = 0.1mA$	$h_{FE(1)}$	20		
	$V_{CE} = 10V, I_C = 1mA$	$h_{FE(2)}$	40		
	$V_{CE} = 10V, I_C = 10mA$	$h_{FE(3)}$	80		
	$V_{CE} = 10V, I_C = 150mA$	$h_{FE(4)}$	100	300	
	$V_{CE} = 1V, I_C = 150mA$	$h_{FE(5)}$	50		
	$V_{CE} = 10V, I_C = 500mA$	$h_{FE(6)}$	40		
Collector-emitter saturation voltage	$I_C = 150mA, I_B = 15mA$	$V_{CE(sat)}$		0.3	V
Base-emitter saturation voltage	$I_C = 150mA, I_B = 15mA$	$V_{BE(sat)}$	0.6	1.2	V
Transition frequency	$V_{CE} = 20V, I_C = 20mA, f = 100MHz$	$f_T$	300		MHz
Delay time	$V_{CC} = 30V, V_{BE(off)} = -0.5V,$	$t_d$		15	ns
Rise time	$I_C = 150mA, I_{B1} = 15mA$	$t_r$		25	ns
Storage time	$V_{CC} = 30V, I_C = 150mA, I_{B1} = I_{B2} = 15mA$	$t_s$		225	ns
Fall time		$t_f$		60	ns

## Rating and Characteristic Curves (MMBT2222A-HF)

Fig.1 - Static Characteristic

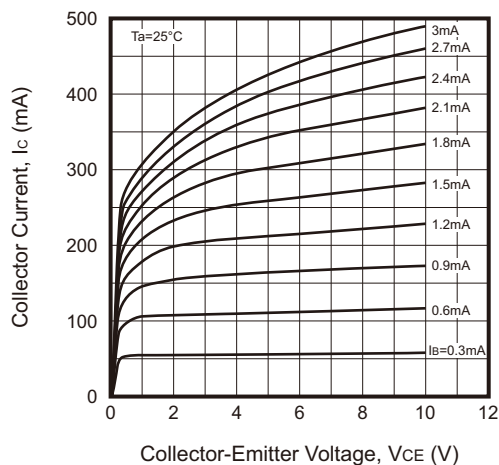
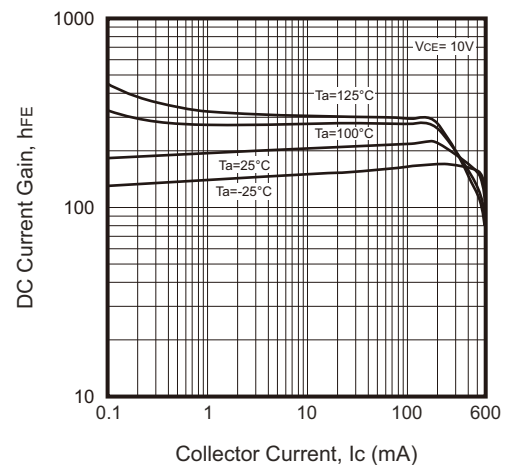

Fig.2 - DC Current Gain



Company reserves the right to improve product design, functions and reliability without notice.

REV:B

## Rating and Characteristic Curves (MMBT2222A-HF)

Fig.3 - Collector-Emitter Saturation Voltage

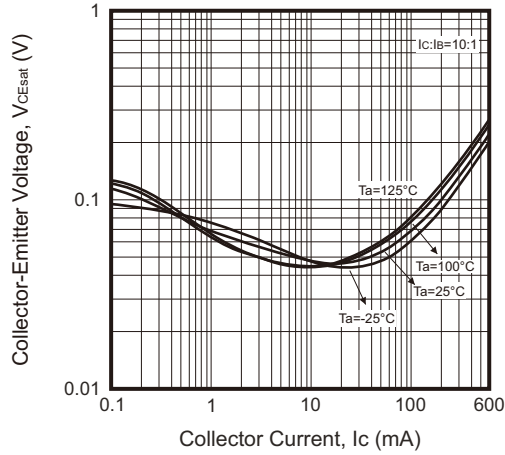

Fig.4 - Base-Emitter Saturation Voltage

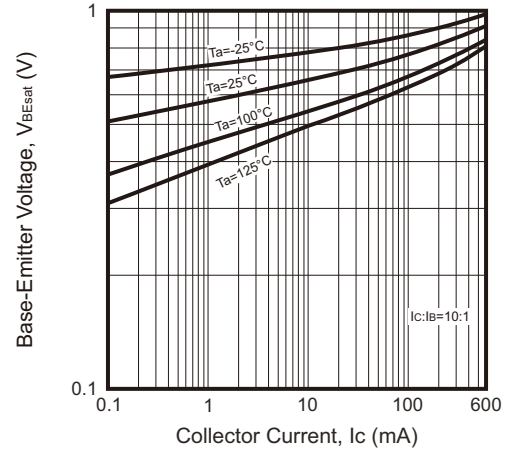

Fig.5 - Base-Emitter on Voltage

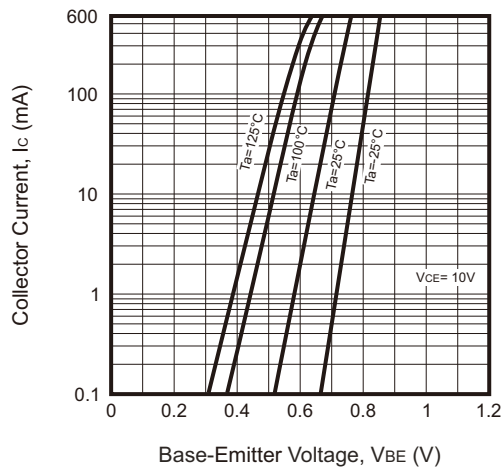

Fig.6 -  $C_{ob}/C_{ib} - V_{CB}/V_{EB}$

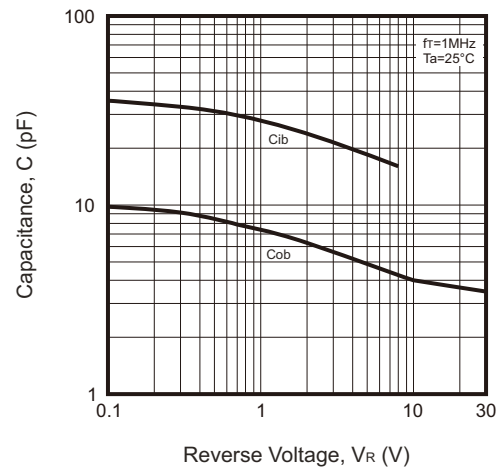
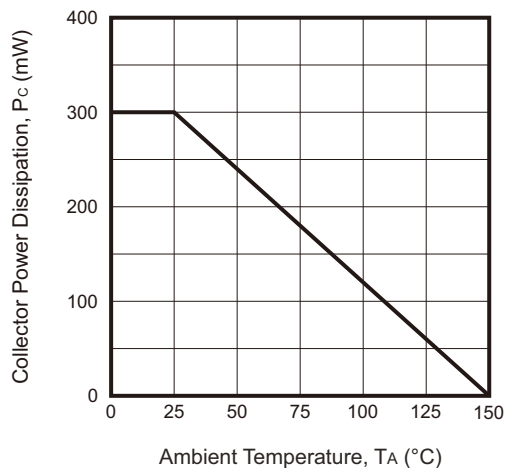
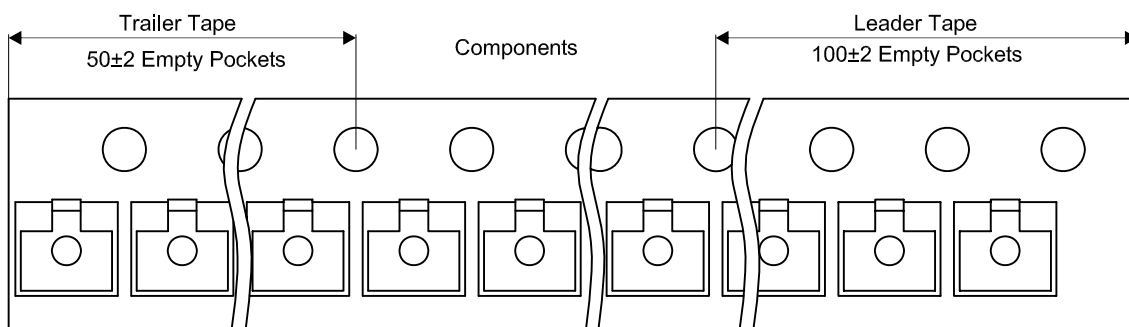
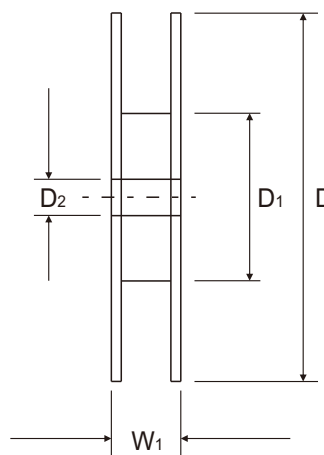
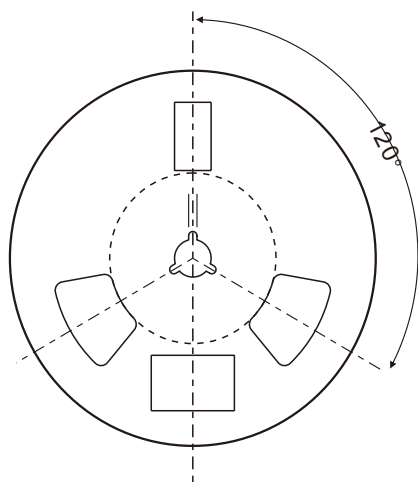
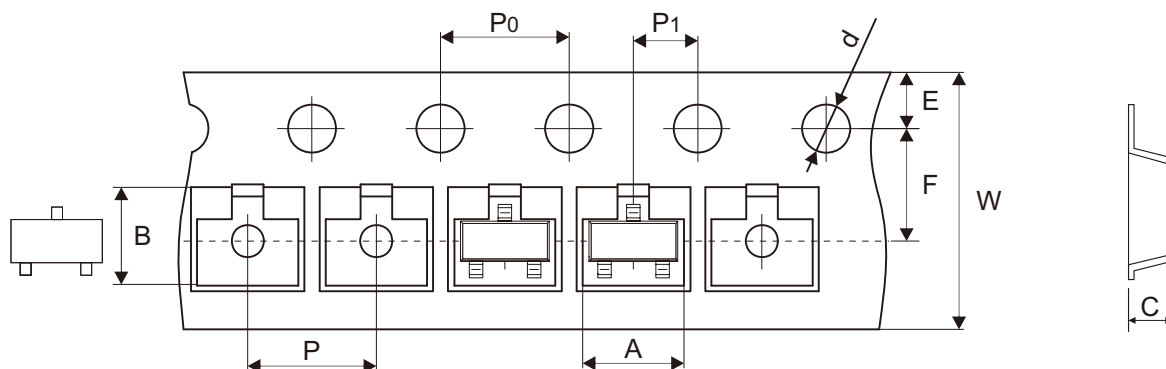

Fig.7 - Collector Power Derating Curve



## Reel Taping Specification



SOT-23	SYMBOL	A	B	C	d	D	D1	D2
	(mm)	3.15 ± 0.10	2.77 ± 0.10	1.22 ± 0.10	1.50 + 0.10 - 0.00	178.00 ± 1.00	54.60 ± 1.00	13.30 ± 1.00
	(inch)	0.124 ± 0.004	0.109 ± 0.004	0.048 ± 0.004	0.059 + 0.004 - 0.000	7.008 ± 0.039	2.150 ± 0.039	0.524 ± 0.039

SOT-23	SYMBOL	E	F	P	P0	P1	W	W1
	(mm)	1.75 ± 0.10	3.50 ± 0.05	4.00 ± 0.10	4.00 ± 0.10	2.00 ± 0.05	8.00 + 0.30 - 0.10	11.10 ± 0.20
	(inch)	0.069 ± 0.004	0.138 ± 0.002	0.157 ± 0.004	0.157 ± 0.004	0.079 ± 0.002	0.315 + 0.012 - 0.004	0.437 ± 0.008

Company reserves the right to improve product design, functions and reliability without notice.

REV:B

## Marking Code

Part Number	Marking Code
MMBT2222A-HF	1P

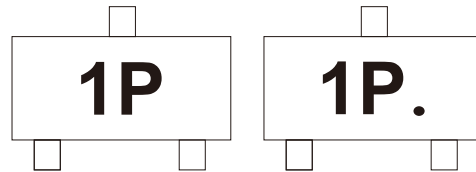

Solid dot = Control code

## Suggested P.C.B. PAD Layout

SIZE	SOT-23	
	(mm)	(inch)
A	0.90	0.035
B	0.80	0.031
C	0.95	0.037
D	2.00	0.079
E	2.90	0.114

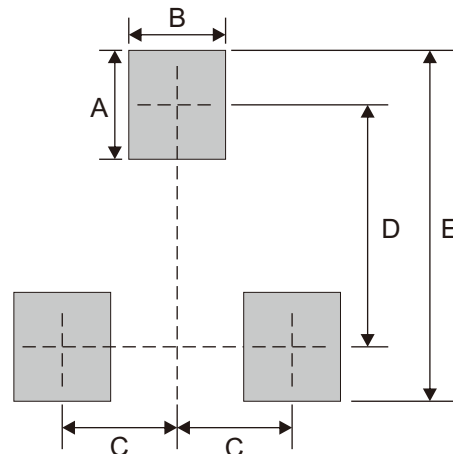

Note: 1. The pad layout is for reference purposes only.

## Standard Packaging

Case Type	REEL PACK	
	REEL (pcs)	Reel Size (inch)
SOT-23	3,000	7