

1. MECHANICAL DIMENSIONS :

REV.	DATE	DESCRIPTION
01	Jan. 11, '18	1st RELEASE

- NOTES:
- MATERIAL:
HOUSING: HIGH THERMOPLASTIC, UL94V-0, BLACK
CONTACTS: T=0.35mm PHOS-BRONZE,
3u" GOLD PLATING ON CONTACT AREA,
NICKEL UNDERPLATING ON ALL AREA,
TIN ON TERMINATION END
SHIELD: T=0.25mm COPPER ZINC ALLOY, NICKEL PLATING
 - OPERATING TEMPERATURE: -40°C~+85°C
 - INSERTION FORCE: 4 POUNDS MAX.
EXTRACTION FORCE: 4 POUNDS MAX.
 - DURABILITY: 750 MATING CYCLED MIN.
 - CAVITY CONFORMS TO FCC RULES AND REGULATIONS PART 68,
SUBPART F.
 - UNSPECIFIED TOLERANCE: .XX ±0.25[0.010]
.X ±0.30[0.012]

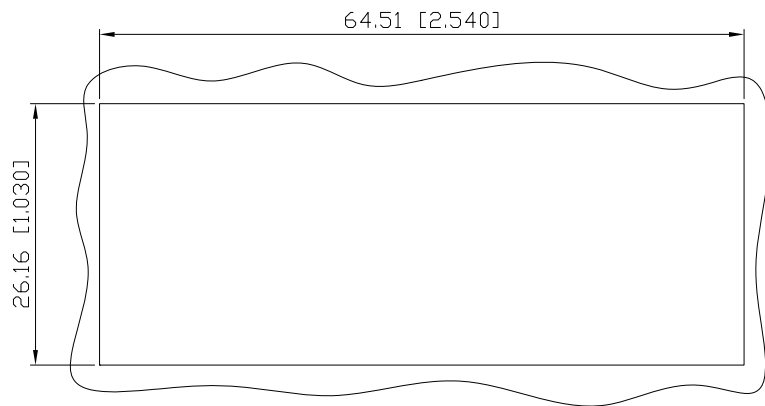

RECOMMENDED
PANEL CUTOUT DIMENSION

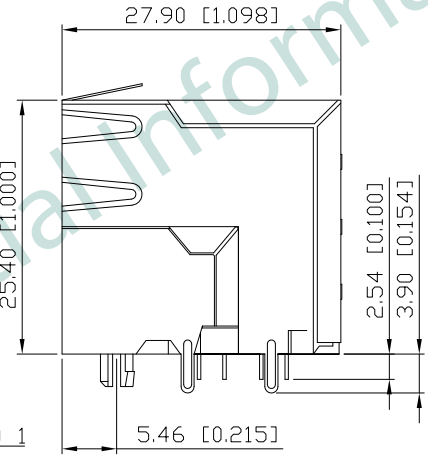
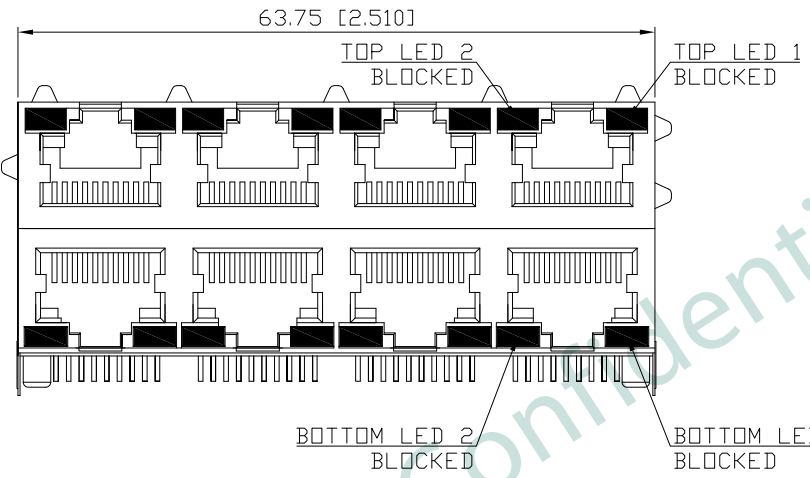

PART NO		KRD-S-24-A-A-0-DN5		
TITLE	RJ45 2X4 10P10C, W/O LED, SHIELDED, STACKED TYPE			
REV : 01				
UNIT	DRAWN	CHKD	DATE	SHEET
mm[inch]	CINDY	DANIEL	Jan. 11, '18	1 of 3

ROHS Compliant

2. PCB LAYOUT :

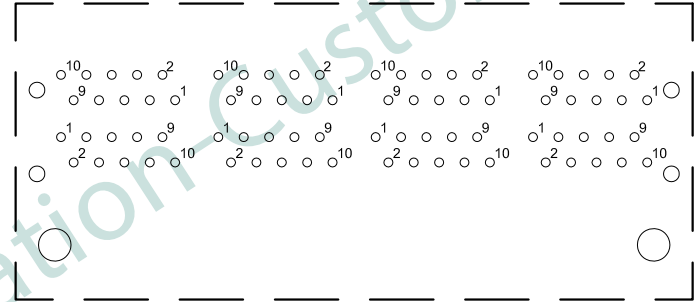
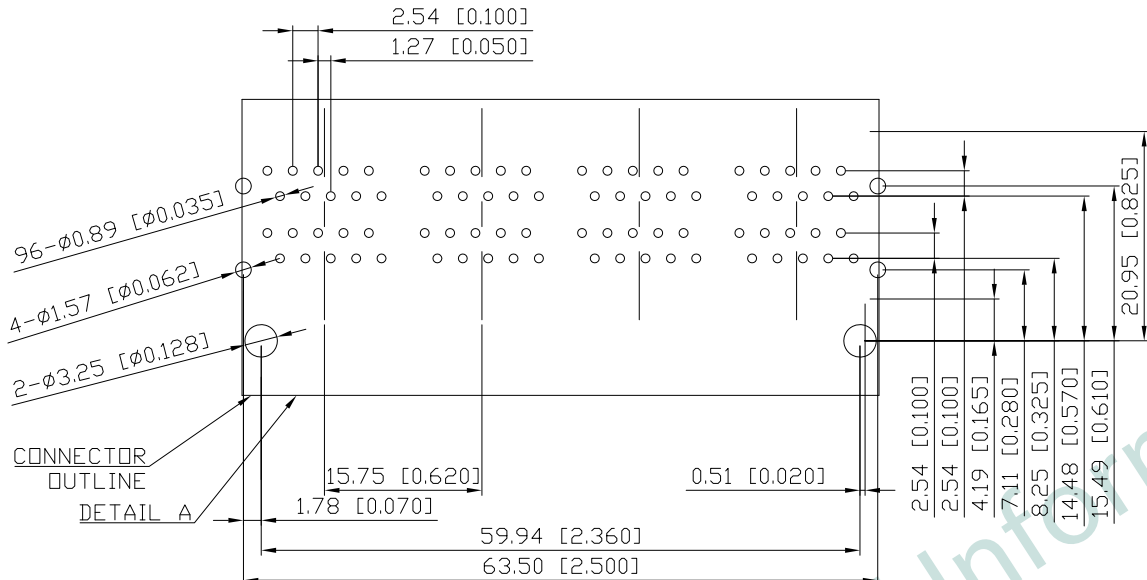

DETAIL A

SUGGESTED PCB LAYOUT
(TOP VIEW)
DIMENSIONAL TOLERANCE: .XX ±0.08[0.003]

KRD-S-24-A-A-0-DN5

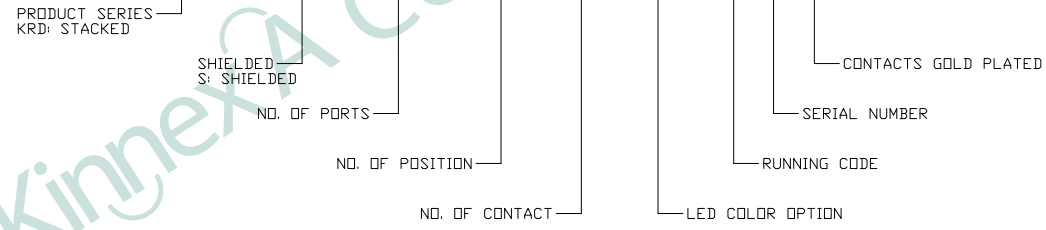

PART NO		KRD-S-24-A-A-0-DN5		
TITLE	RJ45 2X4 10P10C, W/O LED, SHIELDED, STACKED TYPE			
REV : 01				
UNIT	DRAWN	CHKD	DATE	SHEET
mm[inch]	CINDY	DANIEL	Jan. 11, '18	2 of 3

3. PROFILE OF WAVE SOLDER :

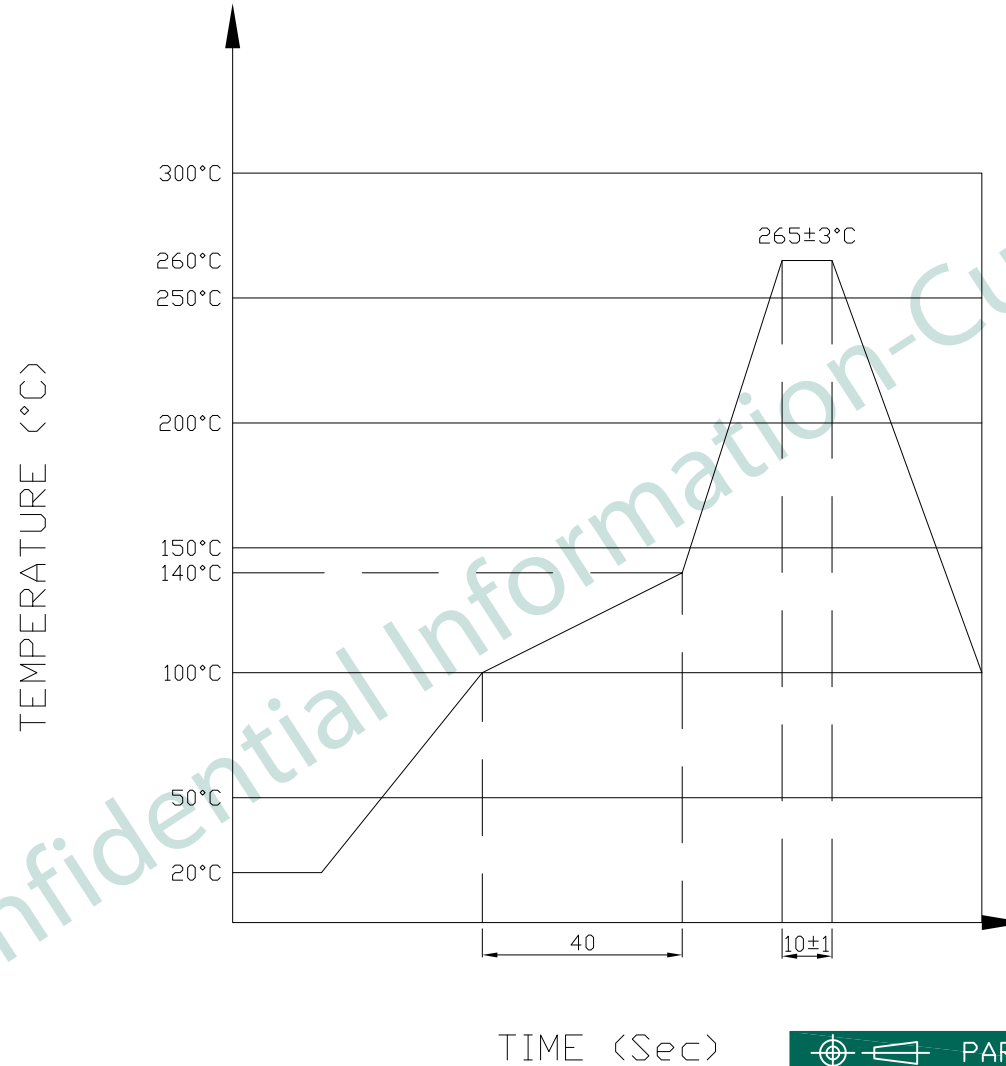

The measuring point for the specified temperature shall be on the soldered part of the lead

PART NO		KRD-S-24-A-A-0-DN5		
TITLE	RJ45 2X4 10P10C, W/O LED, SHIELDED, STACKED TYPE			
REV : 01				
UNIT	DRAWN	CHKD	DATE	SHEET
mm[inch]	CINDY	DANIEL	Jan. 11, '18	3 of 3