

Features

Package	CLCC type Outer dimension: 3.0 x 2.5 x 0.77mm (L x W x H)
Product features	<ul style="list-style-type: none"> • Adjusted to Automotive lighting standards • High reliability, High flux, Low thermal resistance package • Suitable light source for outer lens which is designed by customer Emitting area : 1mm square • Lead-free soldering compatible • RoHS compliant

Recommended Applications

- Exterior light source for Automotive, motorcycle (Head lamp, DRL, Cornering lamp, Fog lamp, etc.)
- LED flood light
- Light source for other equipment

Outline Dimensions

HCNW115AJTE-TR

Unit : mm
 Weight : 20.0mg
 Tolerance : ±0.2

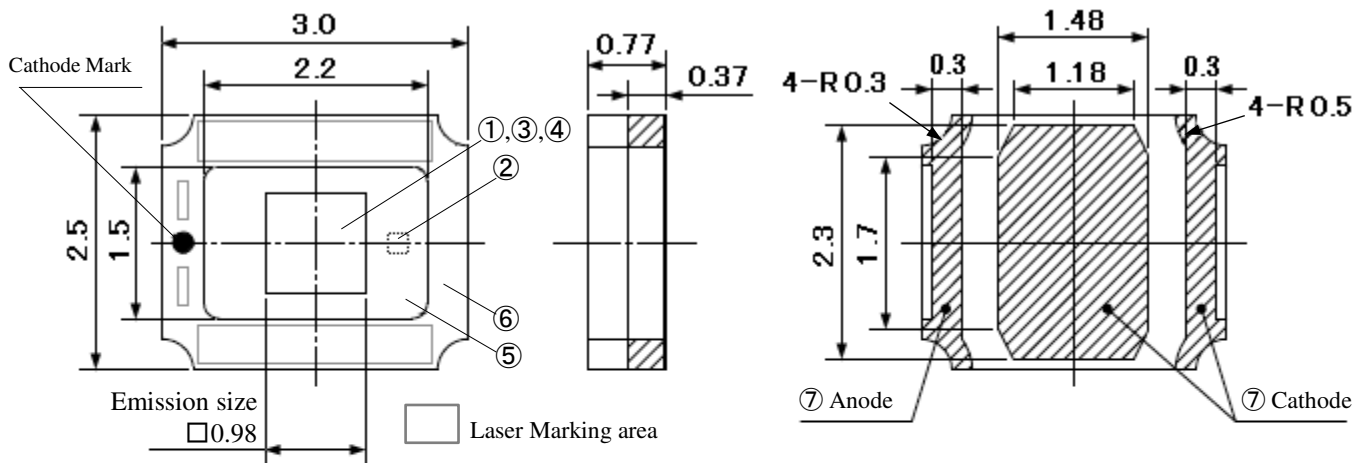

Top view

Side view

Bottom view

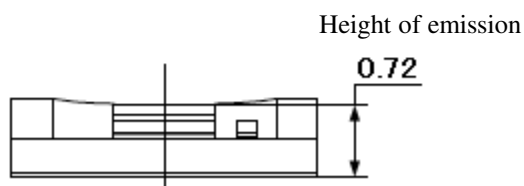

Cross section

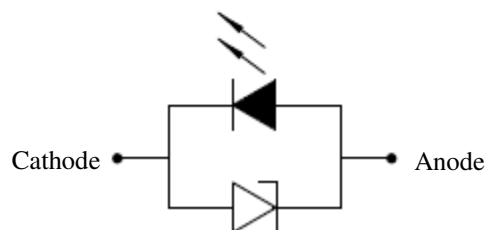

Inside circuit

No.	Part name	Material	Qty.
①	LED Die	InGaN	1
②	Protection Diode	Si	1
③	Encapsulant	Silicone Resin + Phosphor	1
④	Glass plate	Silicone dioxide	1
⑤	Encapsulant	Silicone resin	1
⑥	Lamp housing	Glass ceramic	1
⑦	Electrode	Au plating	Anode:1 Cathode:2

Recommended soldering Pattern

HCNW115AJTE-TR

Unit : mm

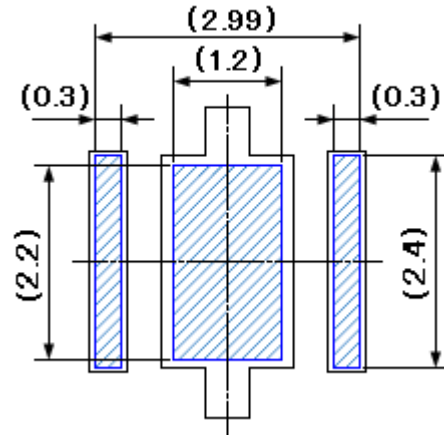
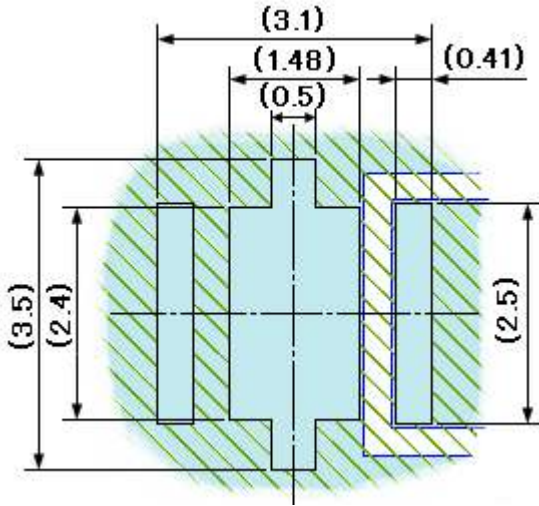



 Cu pattern

 Solder resist

 Solder stencil apertural area

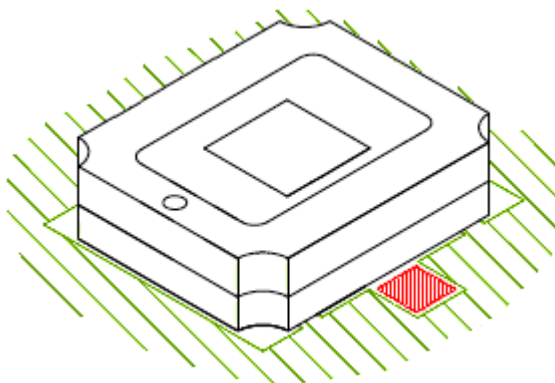
Recommended solder stencil thickness : 150 μ m



 Recommended solder temp. measurement point

【 Product Overview 】

DIE MATERIAL	InGaN
EMITTING COLOR	White
EMISSION AREA COLOR	Yellow
LAMP HOUSING COLOR	White

【 Absolute Maximum Ratings 】

(Ta=25°C)

ITEM	SYMBOL	MAXIMUM RATINGS	UNITS	
Power Dissipation	P_d	5,016	mW	
Forward Current	I_F	100~1,200	mA	
I_F Derate Linearly from " Tj=125°C "	ΔI_F	8.0	mA/°C	
Repetitive Peak Forward Current "1ms, 1/20duty"	I_{FRM}	2,000	mA	
Operating Temperature	T_{opr}	-40 ~ +125	°C	Notes 1
Storage Temperature	T_{stg}	-40 ~ +125	°C	Notes 1
Electro Static Discharge Threshold "HBM"(Ta=25°C)	ESD	±8,000	V	Notes 2
Junction Temperature	T_j	150	°C	Notes 3
Soldering Temperature "Reflow Soldering"	T_{sld}	260	°C	Notes 4

Notes 1 The range of operating and storage temperature are not tapping condition.

Notes 2 ESD testing method : EIAJ4701/300(304) Human Bodu Model (HBM) 1.5kΩ,100pF

Notes 3 Please refer to page 25, "Reliability test results".

Notes 4 Please refer to page 11, "Soldering Conditions".

【 Thermal Characteristics 】

ITEM	SYMBOL	TYP.	MAX.	UNITS
Thermal resistance 【Junction - Solder point】	$R_{th(j-s)}$	3.0	3.9	°C/W

【 Electro-Optical Characteristics 】

							(Ta=25°C)
ITEM	SYMBOL	CONDITIONS	MIN.	TYP.	MAX.	UNITS	
Forward Voltage	V_F	$I_F = 1,000\text{mA}$	2.75	3.25	3.75	V	Notes5
Reverse Voltage	V_R	Not designed for reverse operation				V	Notes6
Luminous Flux	ϕ_v	$I_F = 1,000\text{mA}$	265	310	410	lm	Notes5
Chromaticity Coordinates	C_x	$I_F = 1,000\text{mA}$	-	0.326	-	/	Notes5,7
	C_y		-	0.335	-		
Half Intensity Angle	$\Delta\theta_x$	$I_F = 1,000\text{mA}$	-	117(x-dir)	-	deg.	Notes8
	$\Delta\theta_y$		-	117(y-dir)	-		
Average color rendering index	R_a	$I_F = 1,000\text{mA}$	-	67	-	/	

Note5 Refer to the attached sheets for each sorting chart.

Note6 Do not input reverse voltage and reverse current for prevent the destruction.

Note7 Chromaticity are according to CIE1931.

Note8 Full width of viewing angle at half maximum of I_v . x direction and y direction are as shown in the figure below.

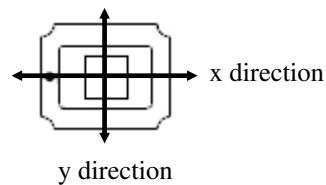

【 Sorting chart For Luminous Flux : Φ_v 】

LEDs shall be sorted out into the following chart and each rank shall be packed separately for shipping.

Rank	Luminous Flux Φ_v (lm)		Conditions
	MIN.	MAX.	
B	265	280	$I_F=1,000\text{mA}$ $T_a=25^\circ\text{C}$
C	280	300	
D	300	330	
E	330	370	
F	370	410	

Notes

Tolerance On Luminous Flux : $\pm 7\%$

Measurement Timing : Instantly After Lighting

【 Sorting Chart For Forward Voltage : V_F 】

LEDs shall be sorted out into the following chart and each rank shall be packed separately for shipping.

Rank	Forward Voltage V_F (V)		Conditions
	MIN.	MAX.	
A	2.75	3.00	$I_F=1,000\text{mA}$ $T_a=25^\circ\text{C}$
B	3.00	3.25	
C	3.25	3.50	
D	3.50	3.75	

Notes

Tolerance On Forward Voltage : $\pm 0.1\text{V}$

Measurement Timing : Instantly After Lighting

【 Sorting chart for Chromaticity : Cx , Cy 】

LED's shall be sorted out into the following chart and each rank shall be packed separately for shipping.

CIE Chromaticity diagram

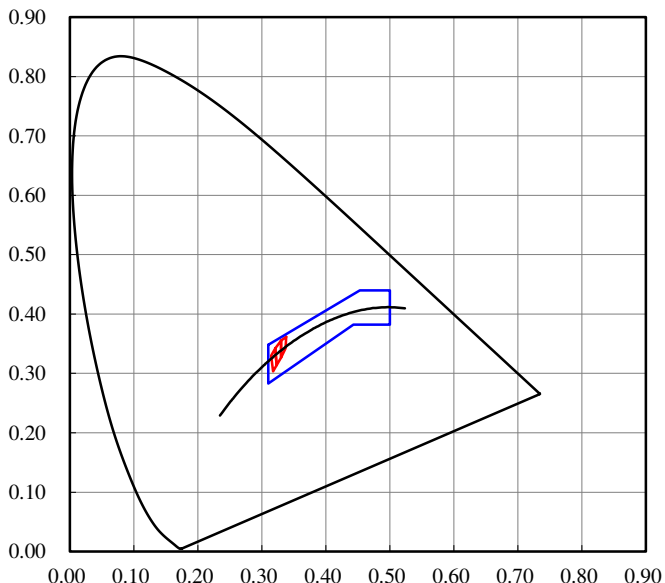

CIE Chromaticity diagram (Enlarged view)

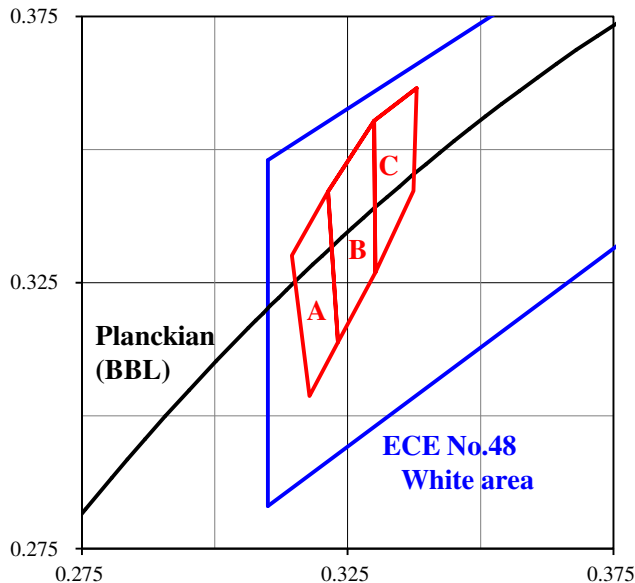

Rank	x	y
A	0.3213	0.3421
	0.3232	0.3138
	0.3178	0.3037
	0.3145	0.3301

Rank	x	y
B	0.3300	0.3554
	0.3302	0.3269
	0.3232	0.3138
	0.3213	0.3421

($I_F=1,000mA$ $T_a=25^\circ C$)

Rank	x	y
C	0.3380	0.3615
	0.3374	0.3422
	0.3302	0.3269
	0.3300	0.3554

Notes

Chromaticity Coordinates Tolerance : ± 0.01

Measurement timing : Instantly after lighting

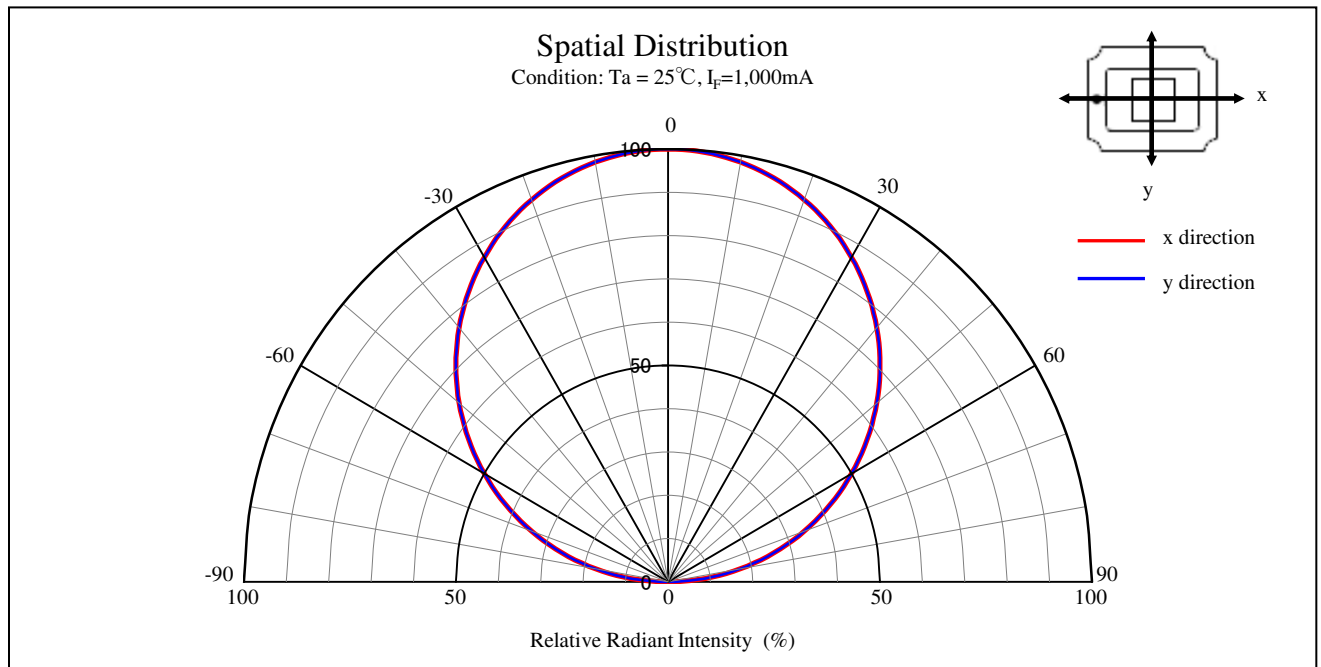
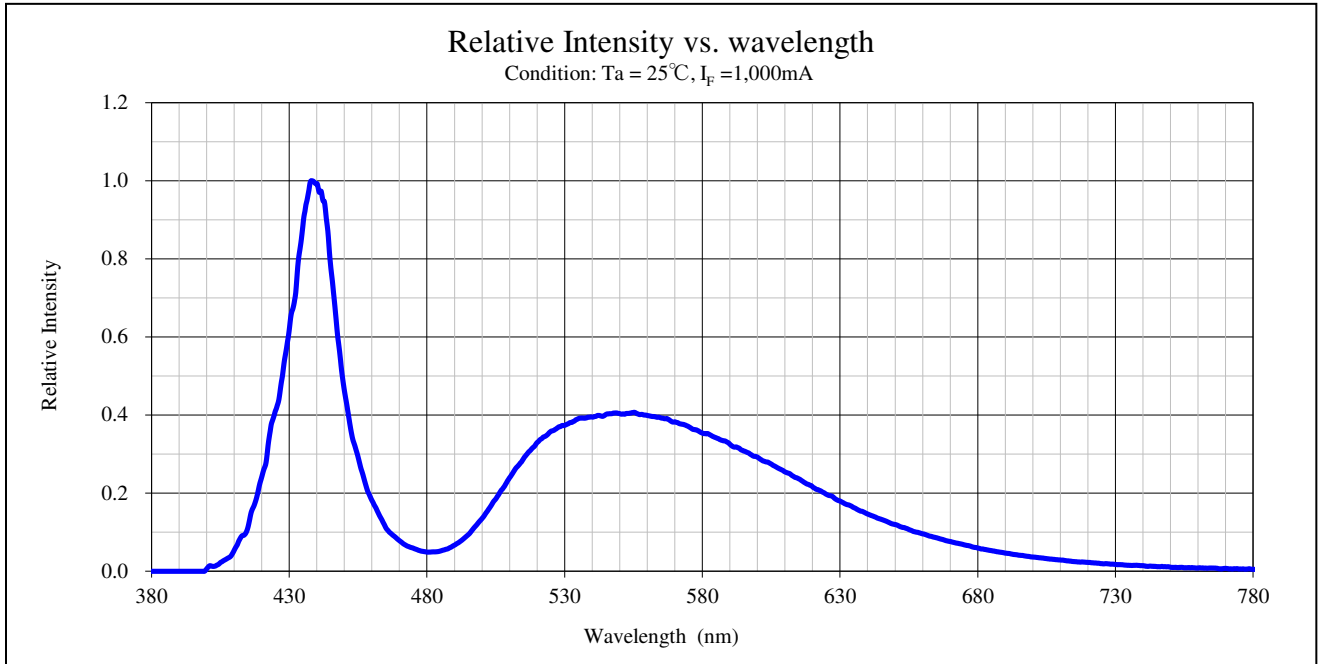

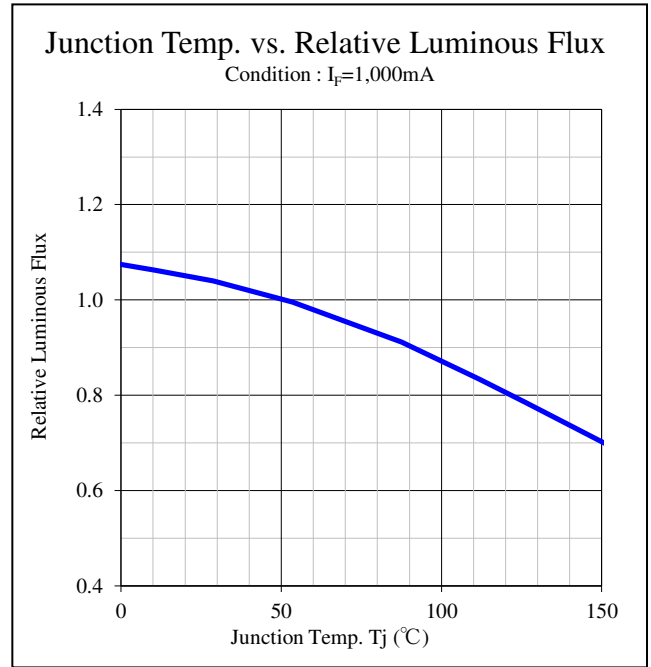
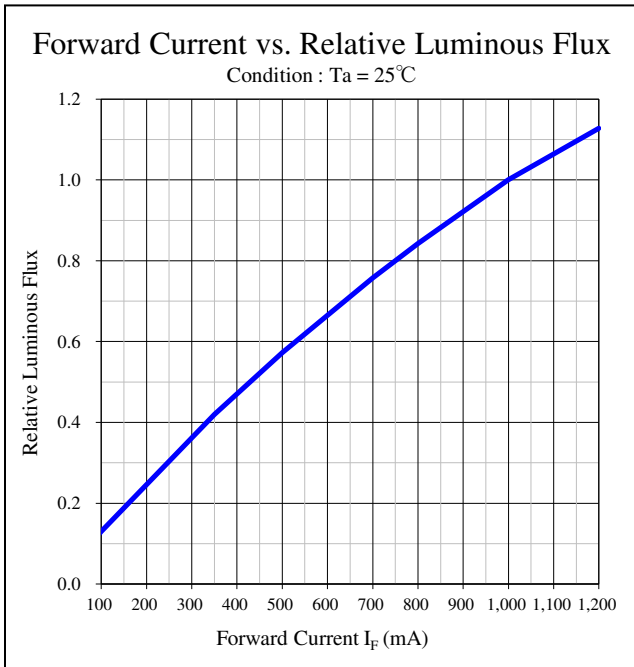
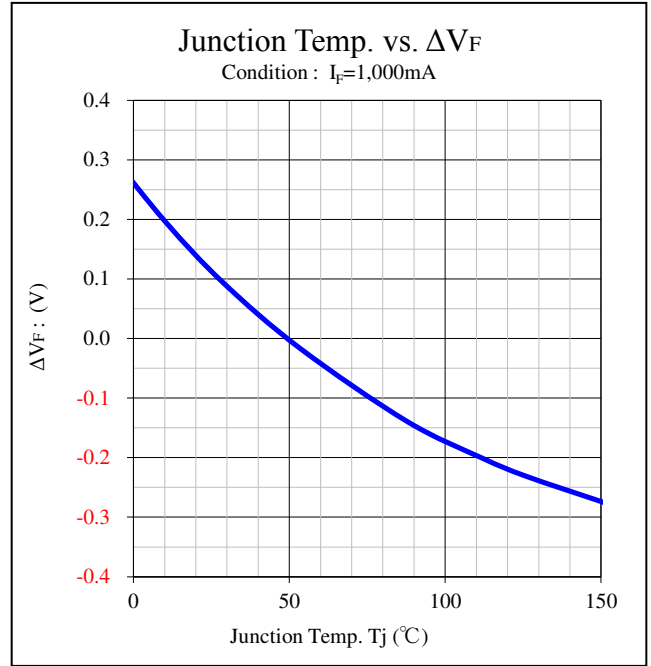
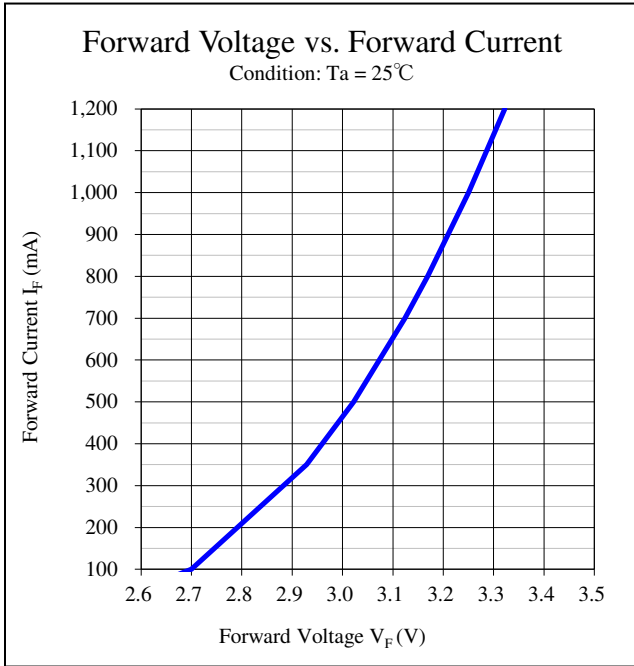

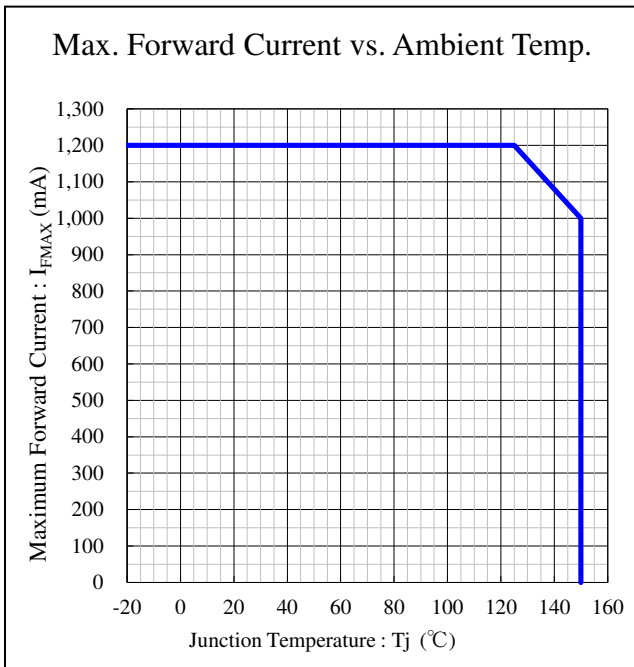
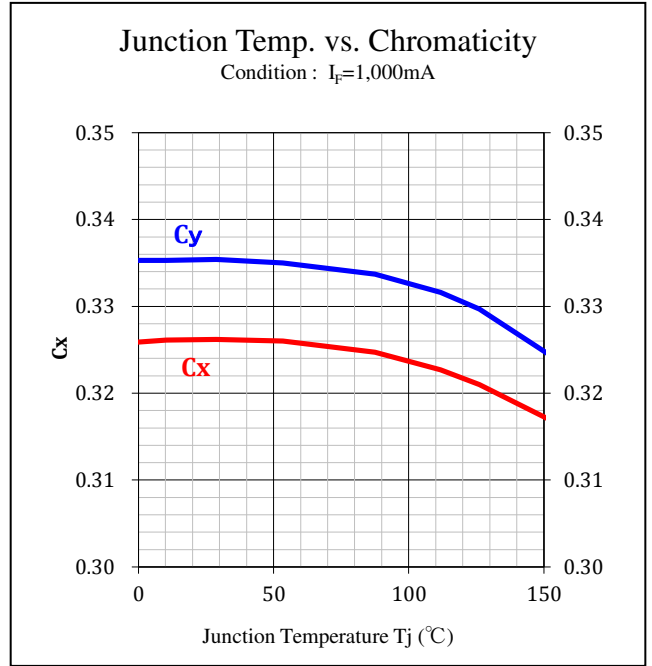
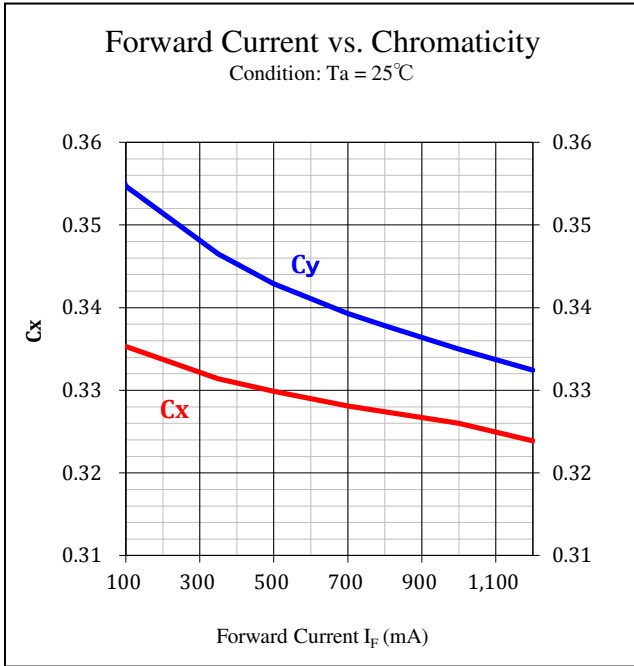

【Soldering Precaution】

(acc.to EIAJ-4701/300)

- Heat stress during soldering will influence the reliability of LEDs, however that effect will vary on heating method. Also, if components of varying shape are soldered together, it is recommended to set the soldering pad temperature according to the component most vulnerable to heat (e.g., surface mount LED).
- LED parts including the resin are not stable immediately after soldering (when they are not at room temperature), any mechanical stress may cause damage to the product. Please avoid such stress after soldering, especially stacking of the boards which may cause the boards to warp and any other types of friction with hard materials.
- Recommended temperature profile for the Reflow soldering is listed as the temperature of the resin surface. Temperature distribution varies on heating method, PCB material, other components in the assembly, and mounting density .
Please do not repeat the heating process in Reflow process more than twice.
- When using a metal PCB, the solder may crack and problems may occur due to major stress on the soldered portion caused by thermal shock. Please carry out a thorough advance verification before use. For the metal PCB's insulation, it is recommended to use stress-reducing materials

【Recommended Reflow Soldering Condition】

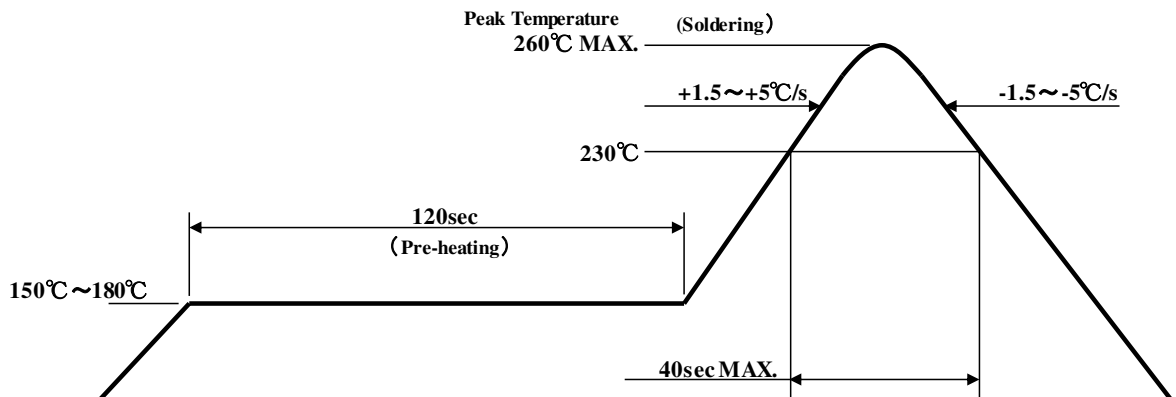

Note 1 Temperature Profile for the reflow should be set to the surface temperature of resin which is on the top of LED. This should be the maximum temperature for soldering. Lowering the heating temperature and decreasing heating time is very effective in achieving higher reliability.

Note 2 The reflow soldering process should be done up to twice(2 times Max). When second process is performed, interval between first and second process should be as short as possible to prevent absorption of moisture to resin of LED. The second soldering process should not be done until LEDs have returned to room temperature (by nature-cooling) after first soldering process.

4. If soldering manually, Stanley recommends using a soldering iron equipped with temperature control. During the actual soldering process, make sure that the soldering iron never touches the LED itself, and avoid the LED's electrode heating temperature reaching above the heating temperature of the solder pad. All repairs must be performed only once in the same spot, and please avoid reusing components.
5. In soldering process, immediately after iron tip is cleaned, please make sure that the soldering iron reaches the appropriate temperature, before using. Also, please avoid applying any types of pressure to the soldered components before the solder has been cooled and hardened, as it may deteriorate solder performance and solder quality.
6. When using adhesive material for tentative fixatives, thermosetting resin or Ultraviolet radiation (UV) setting resin with heat shall be recommended.

【Recommended Manual Soldering Condition】

Temperature of Iron Tip	350°C MAX.
Soldering Duration, Time	3sec. Max., 1 time

7. Flow soldering (dip soldering) is not recommended for this product.
8. Isopropyl alcohol is recommended for cleaning. Some chemicals, including Freon substitute detergent could corrode the lens or the casing surface, which cause discoloration, cloud, crack and so on. Please review the reference chart below for cleaning. If water is used to clean (including the final cleaning process), please use pure water (not tap water), and completely dry the component before using.

《The curing condition, Temperature: 150°C Max./Time: 120sec. Max.》

Chemical	Adaptability
Ethyl Alcohol	○
Isopropyl Alcohol	○
Pure Water	○
Trichloroethylene	×
Chloroethene	×
Acetone	×
Thinner	×
Hexane	×

【For Electric Static Discharge (ESD)】

LED with an InGaN die is sensitive to voltage surges generated by On/Off status change and friction with synthetic materials, which may cause severe damage to the die or undermine its reliability. Damaged products may experience conditions such as extremely high reverse voltage, decrease of forward rise voltage, deterioration in optical characteristics.

Stanley InGaN products are packed with anti-static components. However, following precautions must be taken into account upon product shipment.

1. Electrification/Static Electricity protection

In order to avoid product (die) damage from static electricity caused by unprotected handling by operator and other charged materials coming in contact with the product, Stanley recommends taking the following precautions.

- ① Do not place electrified non-conductive materials near the LED product.
Avoid LED products from coming into contact with metallic materials.(Should the metallic material be electrified , the sudden surge voltage will most likely damage the product.)
- ② Avoid a working process which may cause the LED product to rub against other materials.
- ③ Install ground wires for any equipment, where they can be installed, with measures to avoid static electricity surges.
- ④ Prepare a ESD protective area by placing a Conductive Mattress (1MΩ MAX.) and Ionizer to remove any static electricity.
- ⑤ Operators should wear a protective wrist-strap.
- ⑥ Operators should wear conductive work-clothes and shoes.
- ⑦ To handle the products directly, Stanley recommends the use of ceramic, and not metallic, tweezers.

2. Working Environment

- ① A dry environment is more likely to cause static electricity. Although a dry environment is ideal for storage state of LED products, Stanley recommends an environment with approximately 50% humidity after the soldering process.
- ② Recommended static electricity level in the working environment is 150V, which is the same value as Integrated Circuits (which are sensitive to static electricity).

【Other Precautions】

1. The products are designed to achieve higher performance reliability, however, they can be influenced by usage conditions.
2. Absolute maximum ratings are set to prevent LED products from breaking due to extreme stress (temperature, current, voltage, etc.). These ratings must never be overrun even for a moment.
3. To achieve the highest performance reliability, it is necessary to take into account, factors such as forward voltage adjusted to the usage temperature condition, derating of the power consumption, and other variable factors.
4. Please insert Straight Protective Resistors into the circuit in order to stabilize LED operation and to prevent the device from overheating.
5. Also please make sure there isn't any gas in the surrounding area or entering from outside when using the products.
6. Please avoid to stick foreign materials because molding resin in the products has adhesiveness. And please do not touch emission area..
7. Supersonic wave welding is not recommended because wire open circuit may occur.
ex) bonding outer lens to this product or housing
8. Please check the actual performance in the assembly because the specification sheets are described only for LED device.
9. Please refrain from looking directly at the light source of the LED at high output, as it may harm your vision.
10. The products are designed to perform without failure in the recommended usage conditions.
However, please take the necessary precautions to prevent from a fire, injury, and other unexpected failures.
11. The products are manufactured to be used for ordinary electronic equipment. Please contact our sales staff beforehand when exceptional quality and reliability are required, and the failure or malfunction of the products might directly jeopardize life or health (such as for airplanes, aerospace, medical applications, nuclear reactor control systems and so on).
12. The formal specification sheets shall be exchanged and signed by both parties.

【Handling Precautions for Product Mounting】

<Recommendation>

1. Picking up point with nozzle: Lamp housing of the product (Shown below)

The picking up point should be within lamp housing portion, because the silicone resin used for the lens is soft. (If the nozzle makes contact with the lens, the products might be destroyed)

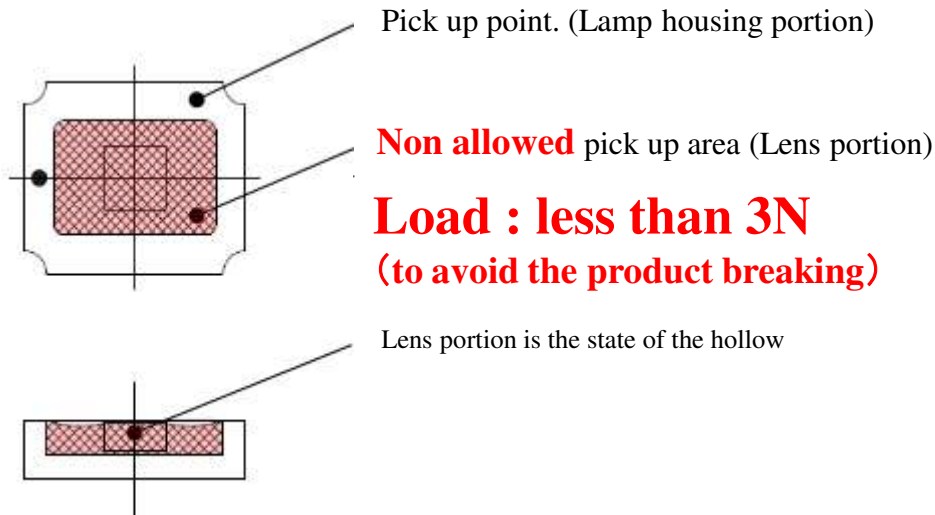

Please adjust the load, the pick up point, the nozzle diameter, etc. before mounting because the over load can cause the breakage of the lamp housing.

2. Recommended Nozzle Shape

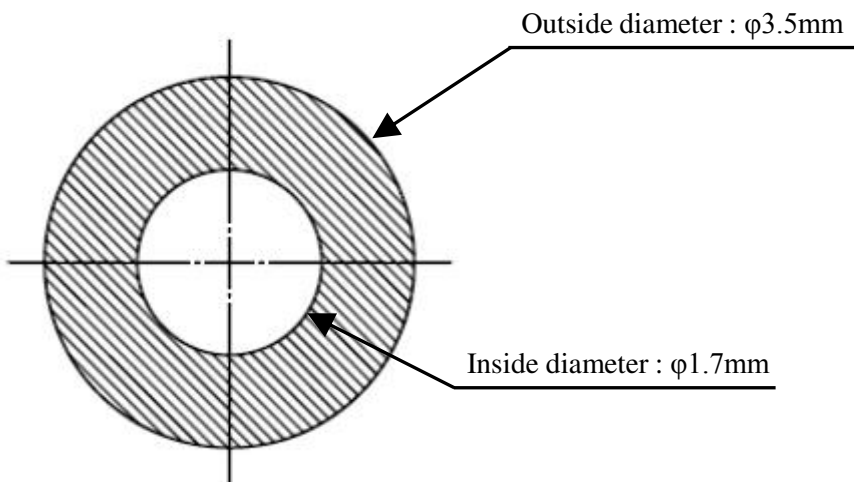

This product is baked (moisture removal) before packaging, and is shipped in moisture-proof packaging (as shown below) to minimize moisture absorption during transportation and storage. However, with regard to storing the products, Stanley recommends the use of dry-box under the following conditions is recommended. Moisture-proof bag as the packaging is made of anti-static material but packaging box is not.

【Recommended Storage Condition / Products Warranty Period】

Temperature	+5~30°C
Humidity	Under 60%

In the case of the package unopened , 6 months under 【 Recommended Storage Condition 】. Please avoid rapid transition from low temp. condition to high temp. condition and storage in corroding and dusty environment.

【Time elapsed after Package Opening】

This product is **equivalent to IPC/JEDEC J-STD-020D MSL 2.**

The package should not be opened until immediately prior to its use.

If any components should remain after their use, please seal the package and store them under the conditions described in the above 【 Recommended Storage Condition 】.

Baking process should be performed after putting out from package.

Baking conditions: **10h(min.), at +60±5°C** just before use

Baking may be performed in the tape-reel form, however if it is performed with the reel stacked over one another, it may case deformation

of the reels and taping materials, which may cause problems during production.

Please make sure that the product has cooled to normal temperature after performing the baking process.

Provided that, baking process shall be 2 times MAX.

【Moisture-proof Packaging Specification】

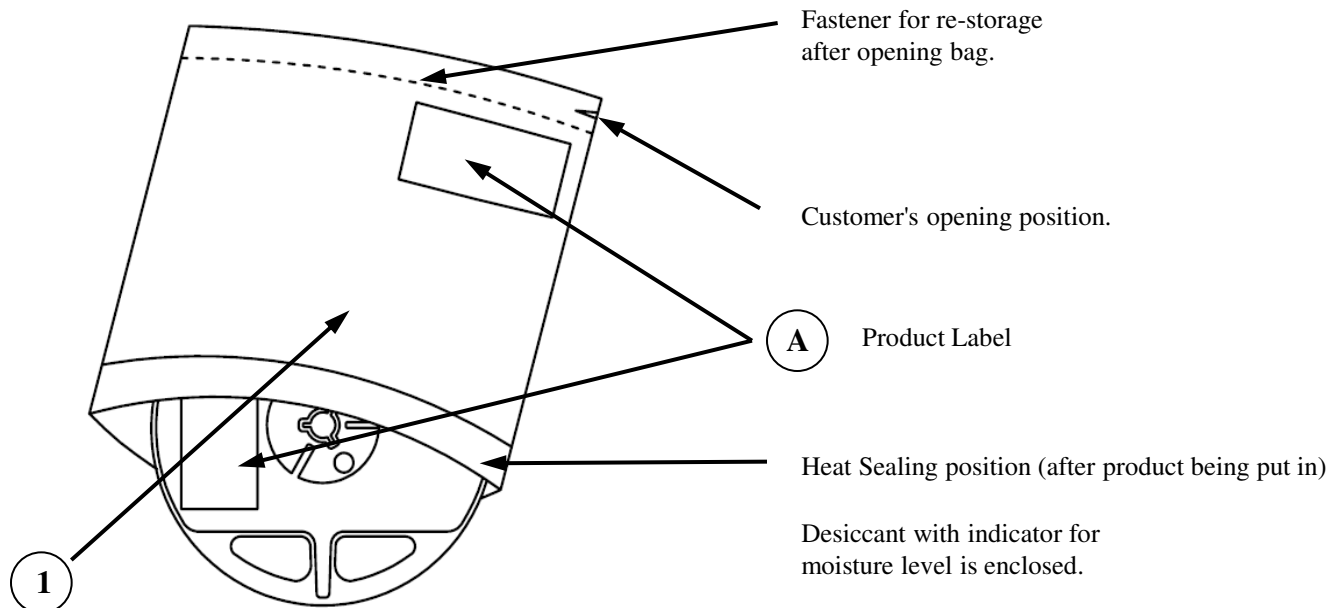

NO.	PART NAME	MATERIALS	REMARKS
①	Moisture-proof bag with Aluminum layer	PET+Al+PE	with ESD protection

【Flow Chart-package Opening to Mounting】

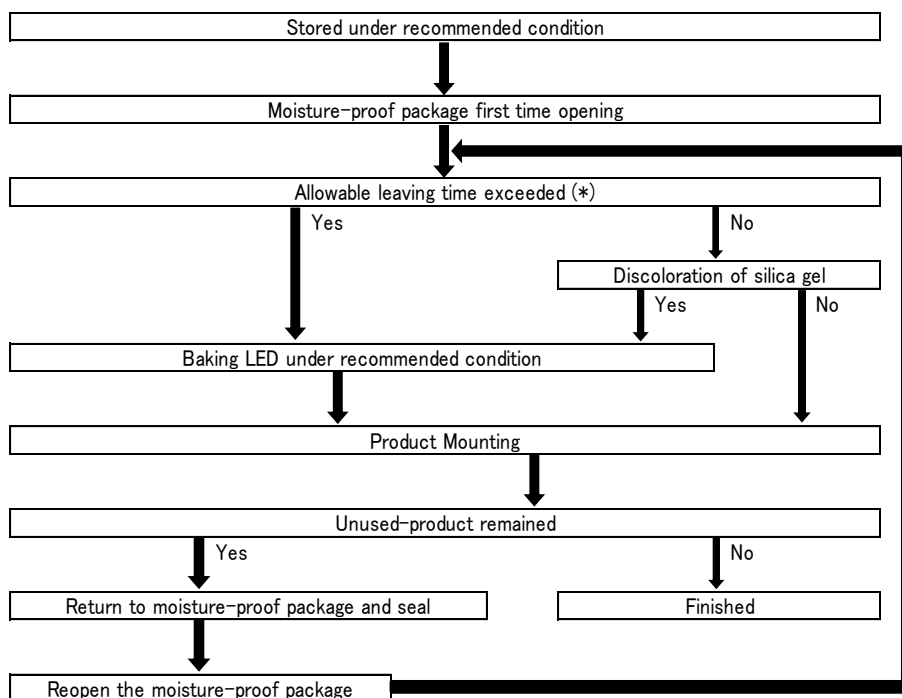

Allowable leaving time means the maximum allowable leaving time after opening package, which depends on each LED type. The allowable leaving time should be calculated from the first opening of package to the time when soldering process is finished. When judging if the allowable leaving time has exceeded or not, please subtract the soldering time. The allowable leaving time after reopening should be calculated from the first opening of package, or from the time when baking process is finished.

【Packing box】

(RoHS・ELV Compliant)

Box TYPE	Outline dimension L × W × H (mm)	Capacity of the box
Type A	280 × 265 × 45	3 reel
Type B	310 × 235 × 265	15 reel
Type C	440 × 310 × 265	30 reel

The above measure is all the reference value.

The box is selected out of the above table by shipping quantity.

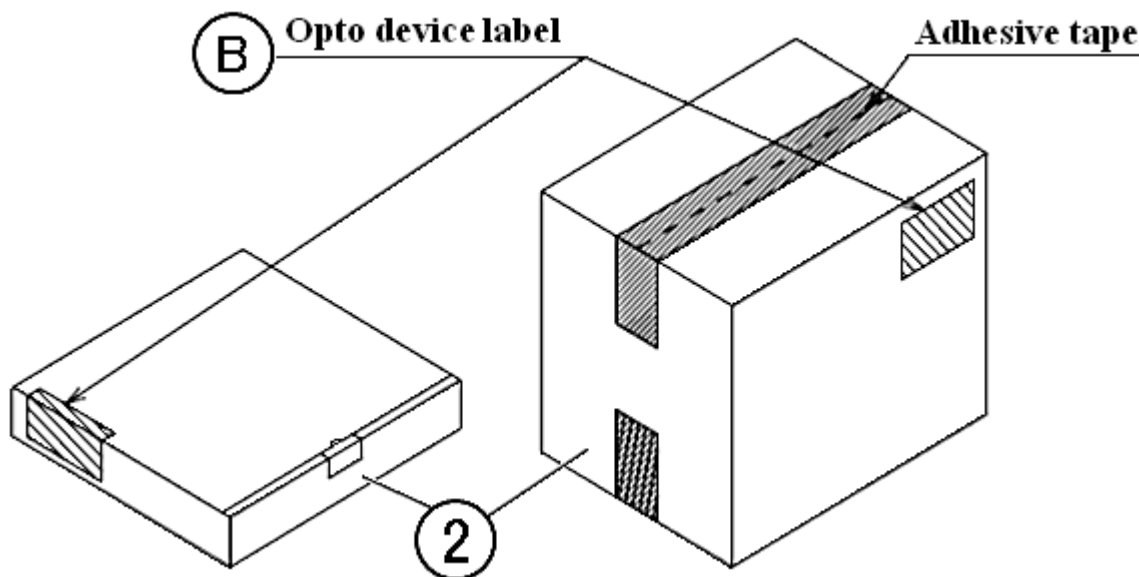

Type A

Material / box : Cardboard C5BF

Type B,C

Material / box : Cardboard K5AF

Partition : Cardboard K5AF

NO.	PART NAME	MATELRIAL	REMARKS
②	Packing Box	Corrugated Cardboard	without ESD protection

(acc.to JIS-X0503(Code-39))

【Label Specification】

A Product label

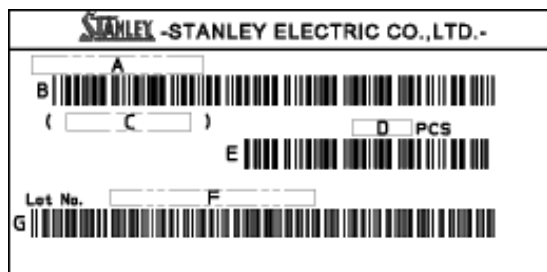

- A. Parts number
 - B. Bar-code for parts number
 - C. Parts code (In-house identification code for each parts number)
 - D. Packed parts quantity
 - E. Bar-Code for packed parts quantity
 - F. Lot number & Rank
- (Please refer to Lot Number Notational System for details)
- G. Bar-Code for Lot number & Rank

B Opto device label

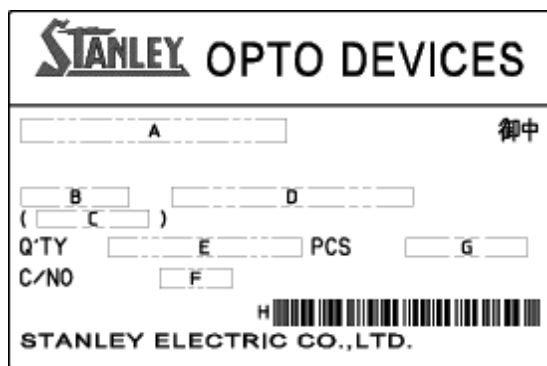

- A. Customer Name
- B. Parts Type
- C. Parts Code
- D. Parts Number
- E. Packed Parts Quantity
- F. Carton Number
- G. Shipping Date
- H. Bar-Code for In-house identification Number

<Remark> Bar-code font : acc.to Code-39(JIX0503)

Taping and Reel Specifications

HCNW115AJTE-TR

(acc.to JIS-C0806-03)

【Appearance】

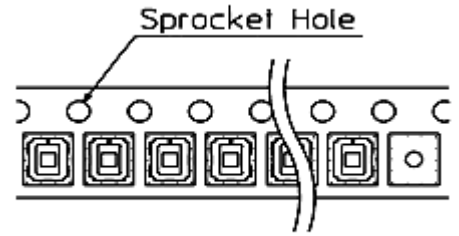
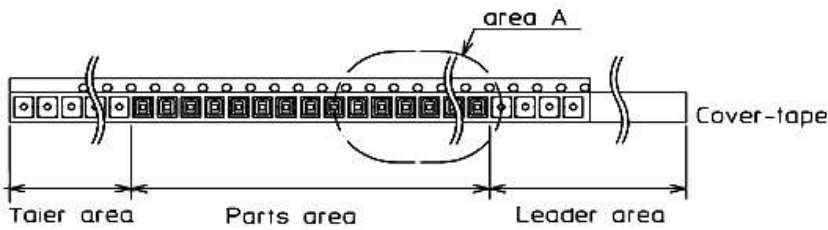

Detailed area A-1

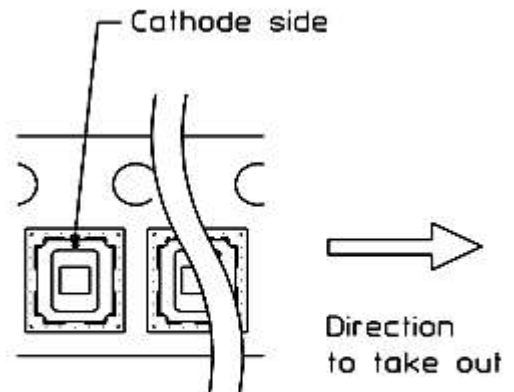
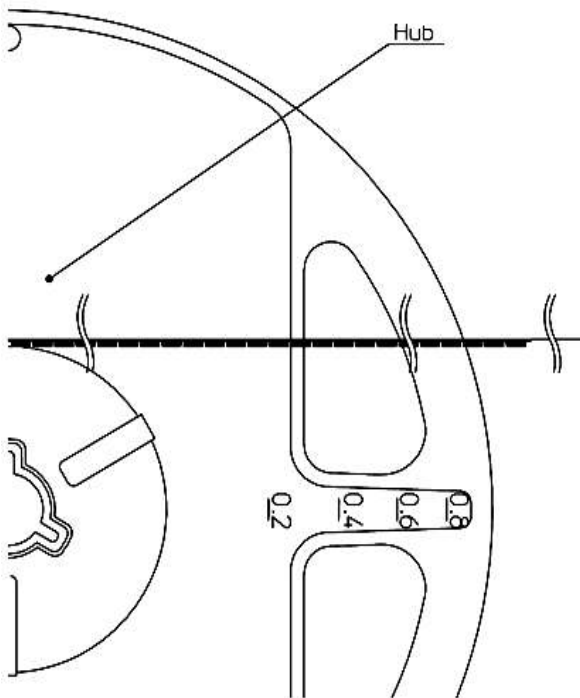

Detailed area A-2

Note

"-TR" means Cathode Side of LEDs should be placed on the sprocket-hole side.

Items		Specifications	Remarks
Leader area	Cover-tape	Cover-tape shall be longer than 300mm without carrier-tape	The end of cover-tape shall be held with adhesive tape.
	Carrier-tape	Empty pocket shall be more than 25 pieces (100mm) .	Please refer to the above figure for Taping & reel orientation .
Trailer area		Empty pocket shall be more than 40 pieces (160mm) .	The end of taping shall be inserted into a slit of the hub.

Taping and Reel Specifications

HCNW115AJTE-TR

(acc.to JIS-C0806-03)

【 Qty. per Reel】

3,000parts/reel

Minimum Qty. per reel might be 500 parts when getting less than 3,000 parts. In such case, parts of 100-unit-qty. Shall be packed in a reel and the qty. shall be identified on the label

【Mechanical strength】

Cover-tape adhesive strength shall be 0.1~1.3N (An angle between carrier-tape and cover-tape shall be170 deg.). Both tapes shall be so sealed that the contained parts will not come out from the tape when it is bent at a radius of 15mm.

【 Others】

Reversed-orientation, Up-side down placing, side placing and out of spec. parts mix shall not be held.
Empty Pocket per reel is assumed until 1 piece.

Taping and Reel Specifications

HCNW115AJTE-TR

(acc.to JIS-C0806-03)

Unit :mm

【Taping Dimensions】

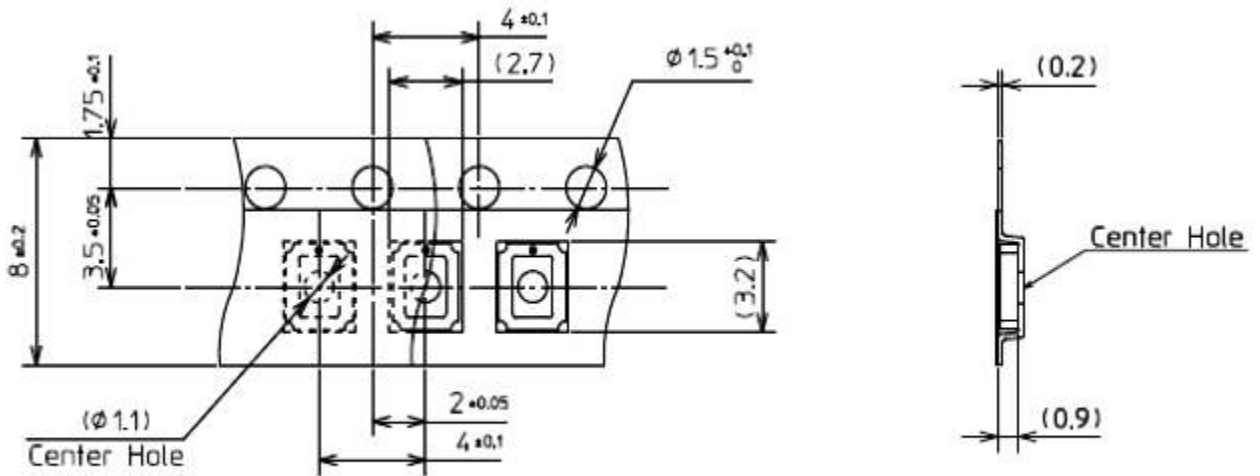

【Reel Dimensions】

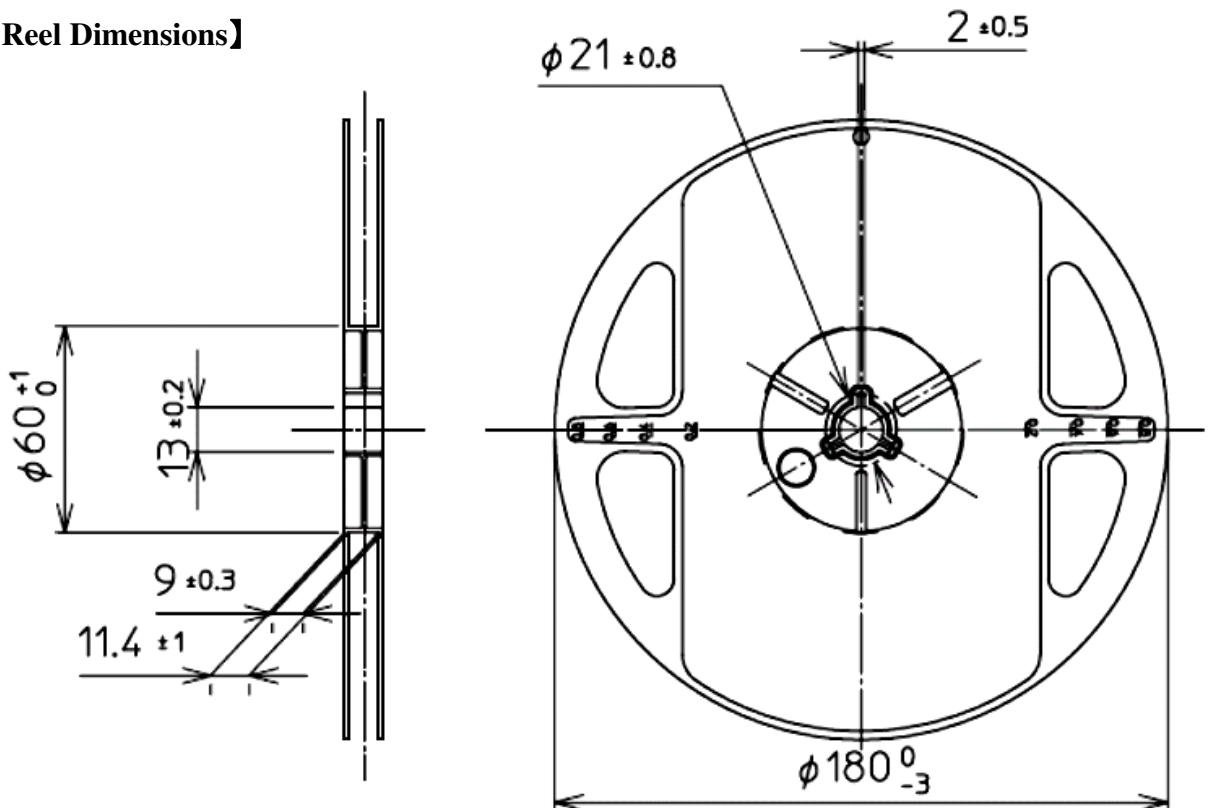

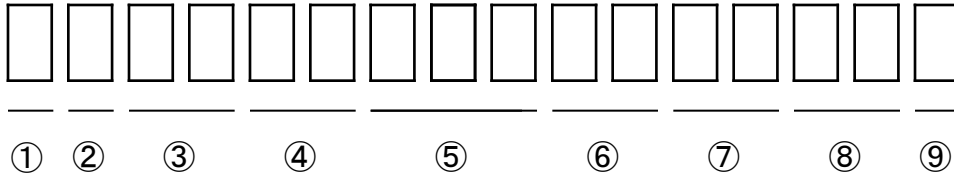

① - 1digit : Production Location (Mark identify alphabet)

② - 1digit : Production Year (Last digit of Production Year 2009→9, 2010→0, 2011→1, …)

③ - 2digits : Production Month (Jan. to Sep. should be 01, 02, 03, …)

④ - 2digits : Production Date

⑤ - 3digits : Serial Number

⑥ - 2digits : Tape and Reel following Number

⑦ - 2digits : Luminous Intensity Rank.

(If luminous intensity rank is 1 digit, "-" shall be dashed on the place for the second digit.
If there is no identified intensity rank, "- -" is used to indicate.)

⑧ - 2digits : Chromaticity Rank

(If chromaticity rank is 1 digit, "-" shall be dashed on the place for the second digit.
If there is no identified intensity rank, "- -" is used to indicate.)

⑨ - 1digit : VF Rank

If there is no identified VF rank, "- -" is used to indicate.

This product is in compliance with RoHS・ELV.

Prohibition substance and it's criteria value of RoHS・ELV are as follows.

- RoHS instruction Refer to following (1)~(6).
- ELV instruction Refer to following (1)~(4).

	Substance Group Name	Criteria Value
(1)	Lead and its compounds	1,000ppm Max
(2)	Cadmium and its compounds	100ppm Max
(3)	Mercury and its compounds	1,000ppm Max
(4)	Hexavalent chromium	1,000ppm Max
(5)	PBB	1,000ppm Max
(6)	PBDE	1,000ppm Max

1. Reliability Testing Result

No.	Test Item	Test Condition	Duration	Failure
1	High Temperature Operating Life	$T_j=150^{\circ}\text{C}$ $I_F=1,000\text{mA}$	5,500hr	0/18
2	Low Temperature Operating Life	$T_a=-40^{\circ}\text{C}$ $I_F=1,000\text{mA}$	1,000hr	0/18
3	High Temperature Humidity Bias	$T_a=85^{\circ}\text{C}$ $R_h=85\%$ $T_j=150^{\circ}\text{C}$ $I_F=1000\text{mA}$	1,000hr	0/18
4	High Temperature Storage Life	$T_a=125^{\circ}\text{C}$	3,000hr	0/18
5	Low Temperature Storage Life	$T_a=-40^{\circ}\text{C}$	1,000hr	0/18
6	Thermal Shock Cycle	$T_a=-40^{\circ}\text{C}(15\text{min.})\sim 125^{\circ}\text{C}(15\text{min.})$ ※As shown in the fig.1 below	1,000cyc	0/18
7	Resistance to Reflow Soldering	Moisture Soak:Jedec Level2 Preheating:150~180°C 120sec MAX. Soldering:260°C 5sec	2times	0/18

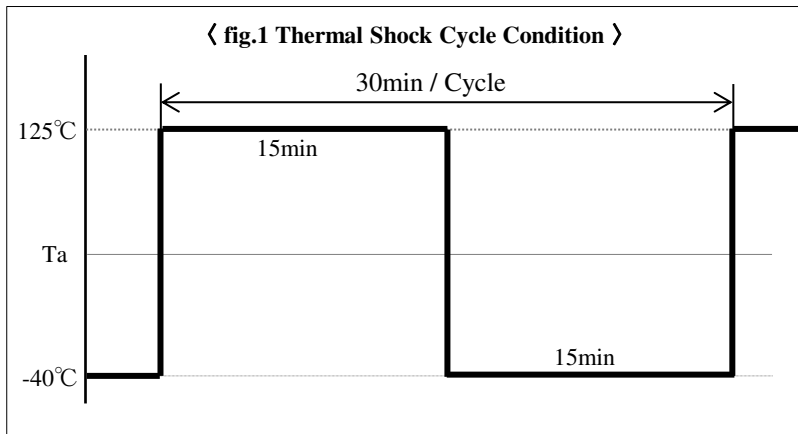

2. Failure Criteria

Item	Symbol	Conditions	Acceptance Criteria
Luminous Intensity	I_V	$I_F=1,000\text{mA}$ $T_a=25^{\circ}\text{C}$	Initial Value $\times 0.8 <$ Testing MIN. Value & Initial Value $\times 1.2 \leq$ Testing MAX. Value
Chromaticity	C_x, C_y	$I_F=1,000\text{mA}$ $T_a=25^{\circ}\text{C}$	Initial Value - 0.02 < Measured Value < Initial Value + 0.02
Forward Voltage	V_F	$I_F=1,000\text{mA}$ $T_a=25^{\circ}\text{C}$	Initial Value $\times 0.9 <$ Measured Value < Initial Value $\times 1.1$
Appearance	—	—	Notable discoloration, deformation and crack

Special Notice to Customers Using the Products and Technical Information Shown in This Data Sheet

- 1) The technical information shown in the data sheets are limited to the typical characteristics and circuit examples of the referenced products. It does not constitute the warranting of industrial property nor the granting of any license.
- 2) For the purpose of product improvement, the specifications, characteristics and technical data described in the data sheets are subject to change without prior notice. Therefore it is recommended that the most updated specifications be used in your design.
- 3) When using the products described in the data sheets, please adhere to the maximum ratings for operating voltage, heat dissipation characteristics, and other precautions for use. We are not responsible for any damage which may occur if these specifications are exceeded.
- 4) The products that have been described to this catalog are manufactured so that they will be used for the electrical instrument of the benchmark (OA equipment, telecommunications equipment, AV machine, home appliance and measuring instrument).
The application of aircrafts, space borne application, transportation equipment, medical equipment and nuclear power control equipment, etc. needs a high reliability and safety, and the breakdown and the wrong operation might influence the life or the human body. Please consult us beforehand if you plan to use our product for the usages of aircrafts, space borne application, transportation equipment, medical equipment and nuclear power control equipment, etc. except OA equipment, telecommunications equipment, AV machine, home appliance and measuring instrument.
- 5) In order to export the products or technologies described in this data sheet which are under the “Foreign Exchange and Foreign Trade Control Law,” it is necessary to first obtain an export permit from the Japanese government.
- 6) No part of this data sheet may be reprinted or reproduced without prior written permission from Stanley Electric Co., Ltd.
- 7) The most updated edition of this data sheet can be obtained from the address below:
<http://www.stanley-components.com/en/>