

SPDT SWITCH GaAs MMIC

■ GENERAL DESCRIPTION

The NJG1806K75 is a 1bit control SPDT switch IC suited for switching transmit receive signals at WLAN application and receive signals at 3G/ LTE systems.

The NJG1806K75 features low insertion loss, high isolation, and high handling power down to 1.8V control voltage at high frequency up to 6GHz.

This switch has ESD protection devices to achieve excellent ESD performances. And the ultra small and ultra thin package of DFN6-75 is adopted.

■ PACKAGE OUTLINE

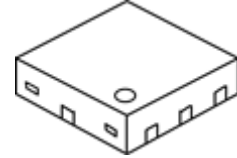

NJG1806K75

■ APPLICATION

- 802.11a/b/g/n/ac/ax networks and 3G/ LTE applications
- WLAN Module/ Repeaters, Cellular phone and others mobile device.

■ FEATURES

- Low control voltage $V_{CTL(H)}=1.8V$ typ.
- Voltage operation $V_{DD}=3.3V$ typ.
- Low insertion loss
 - 0.35dB typ. @f=0.7GHz
 - 0.35dB typ. @f=1.9GHz
 - 0.35dB typ. @f=2.4 to 2.5GHz
 - 0.40dB typ. @f=4.9 to 5.9GHz
- High isolation
 - 30dB typ. @f=0.7GHz
 - 25dB typ. @f=1.9GHz
 - 25dB typ. @f=2.4 to 2.5GHz
 - 25dB typ. @f=4.9 to 5.9GHz
- P-1dB $P_{-1dB}=+31dBm$ typ. @0.7 to 5.9 GHz
- Ultra small & ultra thin package DFN6-75 (Package Size: 1.0x1.0x0.375mm typ.)
- RoHS compliant and Halogen Free, MSL1

■ PIN CONFIGURATION

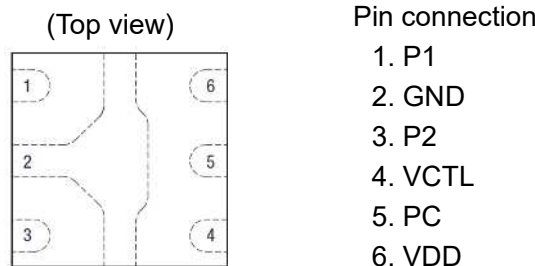

■ TRUTH TABLE

“H”= $V_{CTL(H)}$, “L”= $V_{CTL(L)}$

ON PATH	VCTL
PC-P1	H
PC-P2	L

NOTE: Please note that any data or drawing in this catalog is subject to change.

■ ABSOLUTE MAXIMUM RATINGS

$T_a=+25^{\circ}\text{C}$, $Z_s=Z_l=50\Omega$

PARAMETER	SYMBOL	CONDITIONS	RATINGS	UNITS
RF Input Power	P_{IN}	$V_{DD}=3.3\text{V}$, ON State Port	+31	dBm
Supply Voltage	V_{DD}		6.0	V
Control Voltage	V_{CTL}		6.0	V
Power Dissipation	P_D	4-layer FR4 PCB with through-hole (76.2x114.3mm), $T_j=150^{\circ}\text{C}$	380	mW
Operating Temperature	T_{opr}		-40 to +105	$^{\circ}\text{C}$
Storage Temperature	T_{stg}		-55 to +150	$^{\circ}\text{C}$

■ ELECTRICAL CHARACTERISTICS1 (DC CHARACTERISTICS)

(General conditions: $T_a=+25^{\circ}\text{C}$, with application circuit)

PARAMETERS	SYMBOL	CONDITIONS	MIN	TYP	MAX	UNITS
Supply Voltage	V_{DD}		2.5	3.3	5.0	V
Operating Current	I_{DD}	No RF input, $V_{DD}=3.3\text{V}$	-	15	30	μA
Control Voltage (HIGH)	$V_{CTL(H)}$		1.35	1.8	5.0	V
Control Voltage (LOW)	$V_{CTL(L)}$		0	-	0.45	V
Control Current	I_{CTL}	$V_{CTL(H)}=1.8\text{V}$	-	3	10	μA

■ ELECTRICAL CHARACTERISTICS2 (RF CHARACTERISTICS)

(General conditions: $V_{DD}=3.3V$, $V_{CTL(H)}=1.8V$, $V_{CTL(L)}=0V$, $T_a=+25^{\circ}C$, $Z_S=Z_I=50\Omega$, with application circuit)

PARAMETERS	SYMBOL	CONDITIONS	MIN	TYP	MAX	UNITS
Insertion loss 1	LOSS1	f=0.7GHz	-	0.35	0.55	dB
Insertion loss 2	LOSS2	f=1.9GHz,	-	0.35	0.55	dB
Insertion loss 3	LOSS3	f=2.4 to 2.5GHz	-	0.35	0.55	dB
Insertion loss 4	LOSS4	f=4.9 to 5.9GHz	-	0.40	0.60	dB
Isolation 1	ISL1	f=0.7GHz	28	30	-	dB
Isolation 2	ISL2	f=1.9GHz	23	25	-	dB
Isolation 3	ISL3	f=2.4 to 2.5GHz	23	25	-	dB
Isolation 4	ISL4	f=4.9 to 5.9GHz	23	25	-	dB
Return loss 1	RL1	f=0.7GHz	15	20	-	dB
Return loss 2	RL2	f=1.9GHz	18	28	-	dB
Return loss 3	RL3	f=2.4 to 2.5GHz	18	28	-	dB
Return loss 4	RL4	f=4.9 to 5.9GHz	15	20	-	dB
Input power at 1dB compression point	P_{-1dB}	f=0.7 to 5.9GHz	+28	+31	-	dBm
Switching time	T_{SW}	50% V_{CTL} to 10%/90% RF	-	150	300	ns

■ TERMINAL INFORMATION

No.	SYMBOL	DESCRIPTION
1	P1	RF terminal. An external DC blocking capacitor is required.
2	GND	Ground terminal. Please connect this terminal with ground plane as close as possible for excellent RF performance.
3	P2	RF terminal. An external DC blocking capacitor is required.
4	VCTL	Control voltage input terminal. This terminal is set to High-Level (+1.35 to +5.0V) or Low-Level (0 to +0.45V).
5	PC	Common RF terminal. An external DC blocking capacitor is required.
6	VDD	Positive voltage supply terminal. The positive voltage (+2.5 to +5.0V) has to be supplied. Please connect a bypass capacitor with GND terminal for excellent RF performance.

ELECTRICAL CHARACTERISTICS

General conditions: $V_{DD}=3.3V$, $V_{CTL}=1.8/0V$, $f=0.7$ to $2.0GHz$, $T_a=+25^\circ C$, $Z_S=Z_I=50\Omega$, with application circuit

Loss, ISL vs Frequency

(PC-P1 ON, $V_{DD}=3.3V$, $V_{CTL}=1.8V$)

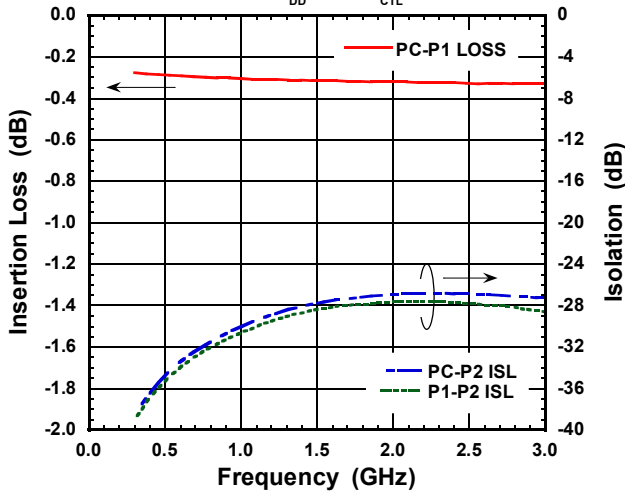

Loss, ISL vs Frequency

(PC-P2 ON, $V_{DD}=3.3V$, $V_{CTL}=0V$)

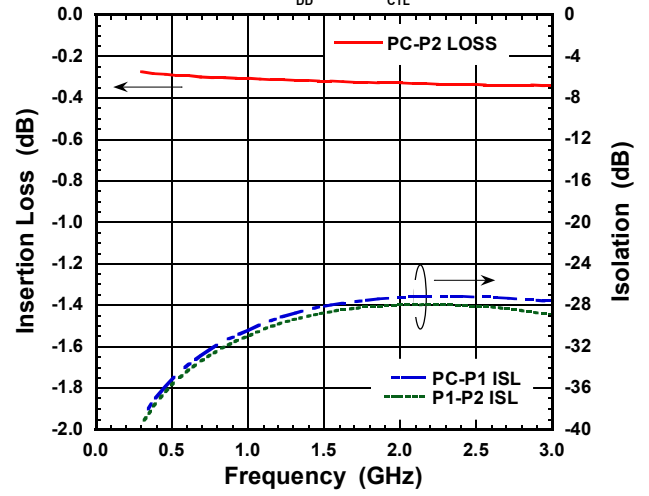

Return Loss vs Frequency

(PC-P1 ON, $V_{DD}=3.3V$, $V_{CTL}=1.8V$)

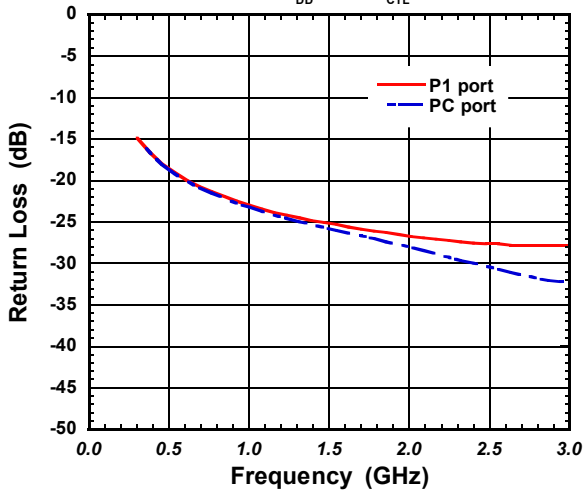

Return Loss vs Frequency

(PC-P2 ON, $V_{DD}=3.3V$, $V_{CTL}=0V$)

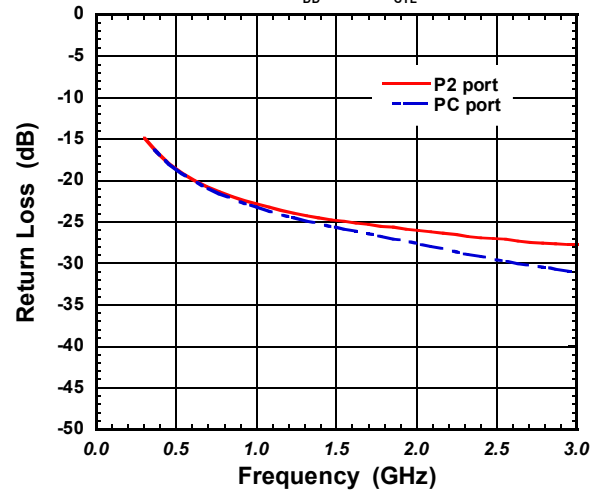

■ ELECTRICAL CHARACTERISTICS

General conditions: $V_{DD}=3.3V$, $V_{CTL}=1.8/0V$, $f=2.0$ to $5.9GHz$, $T_a=+25^\circ C$, $Z_S=Z_I=50\Omega$, with application circuit

Loss, ISL vs Frequency

(PC-P1 ON, $V_{DD}=3.3V$, $V_{CTL}=1.8V$)

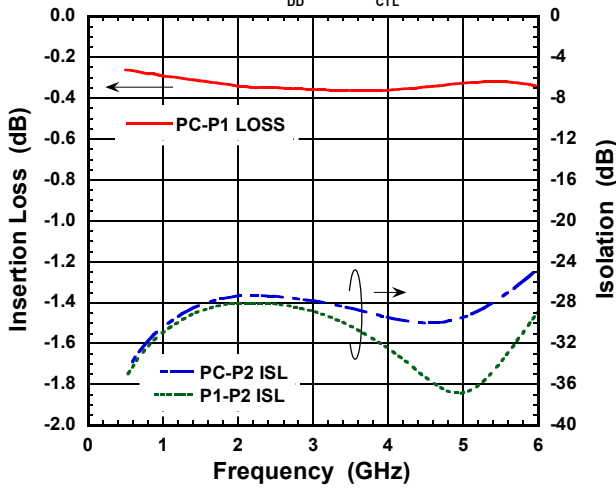

Loss, ISL vs Frequency

(PC-P2 ON, $V_{DD}=3.3V$, $V_{CTL}=0V$)

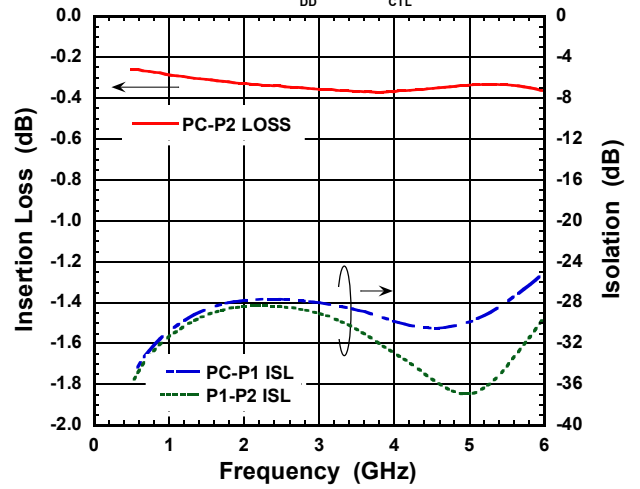

Return Loss vs Frequency

(PC-P1 ON, $V_{DD}=3.3V$, $V_{CTL}=1.8V$)

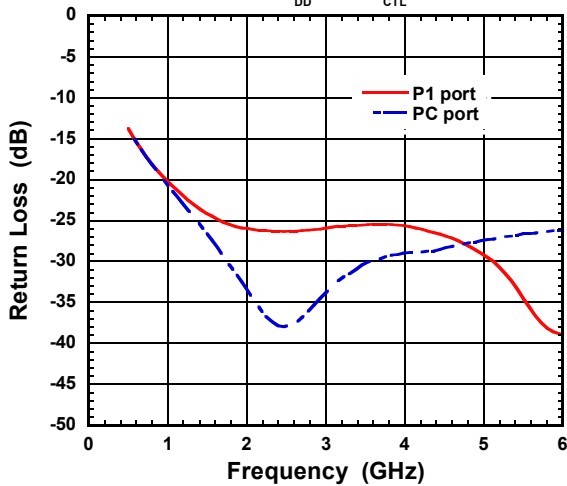

Return Loss vs Frequency

(PC-P2 ON, $V_{DD}=3.3V$, $V_{CTL}=0V$)

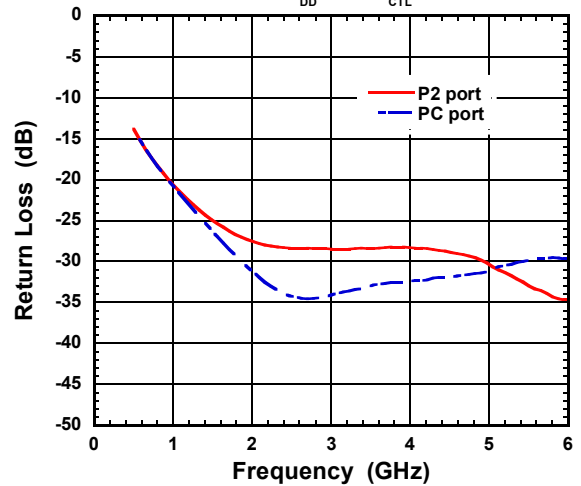

ELECTRICAL CHARACTERISTICS

General conditions: $V_{DD}=3.3V$, $V_{CTL}=1.8/0V$, $T_a=+25^\circ C$, $Z_S=Z_I=50\Omega$, with application circuit

Loss, ISL vs Input Power

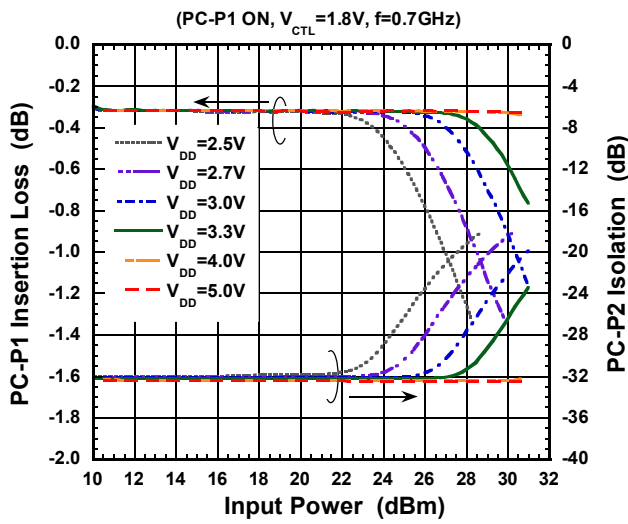

Loss, ISL vs Input Power

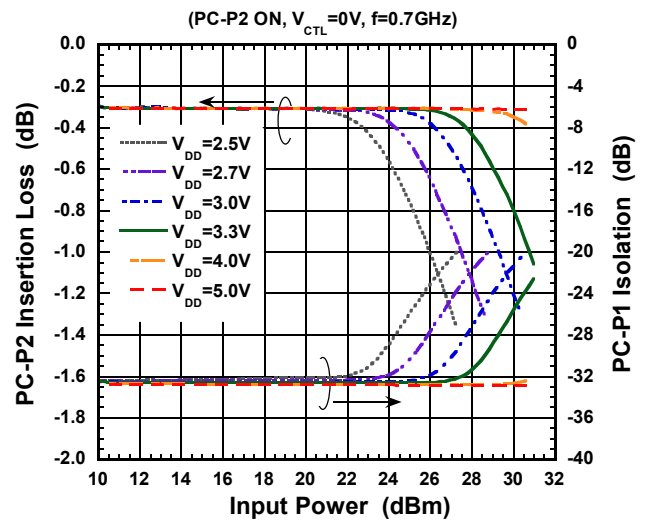

Loss, ISL vs Input Power

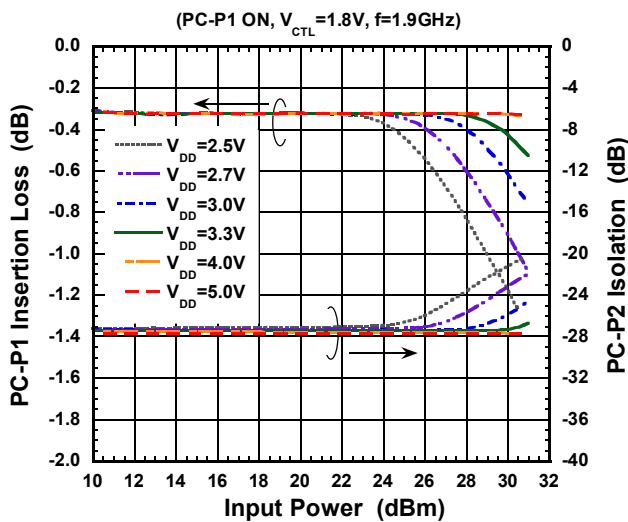

Loss, ISL vs Input Power

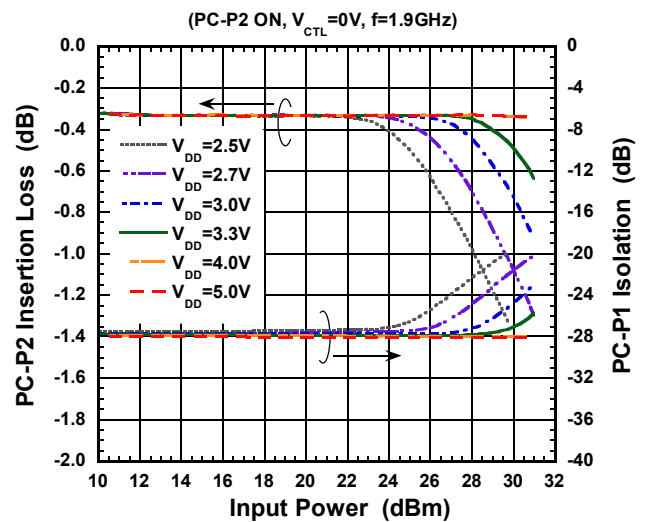

Loss, ISL vs Input Power

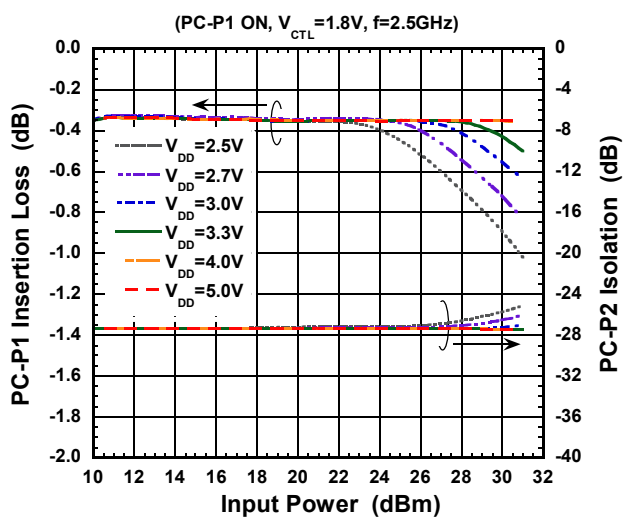

Loss, ISL vs Input Power

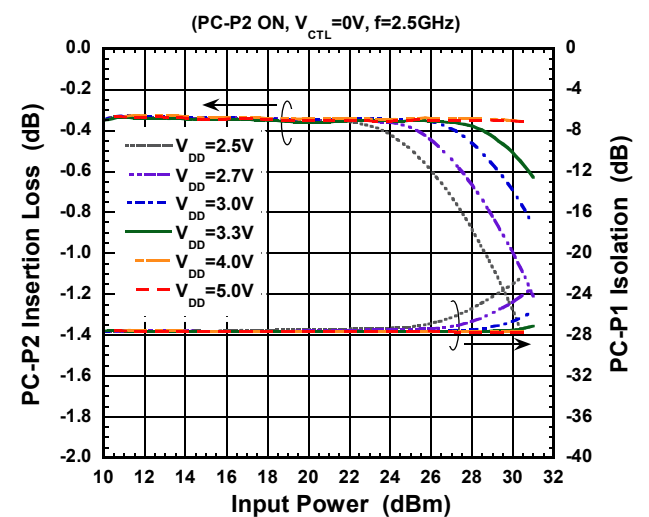

■ ELECTRICAL CHARACTERISTICS

General conditions: $V_{DD}=3.3V$, $V_{CTL}=1.8/0V$, $T_a=+25^\circ C$, $Z_S=Z_I=50\Omega$, with application circuit

Loss, ISL vs Input Power

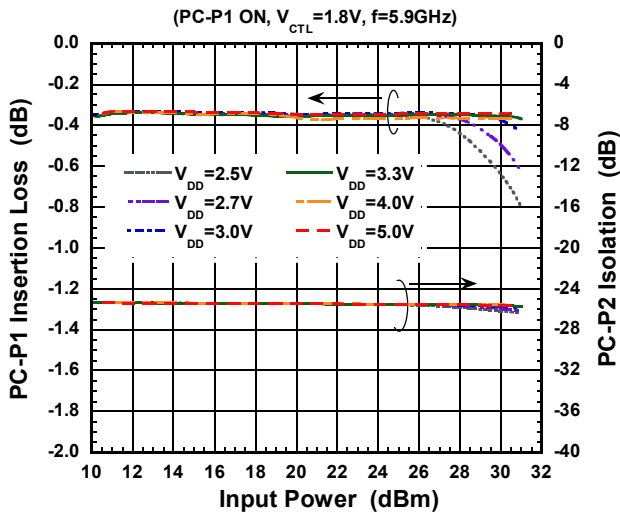

Loss, ISL vs Input Power

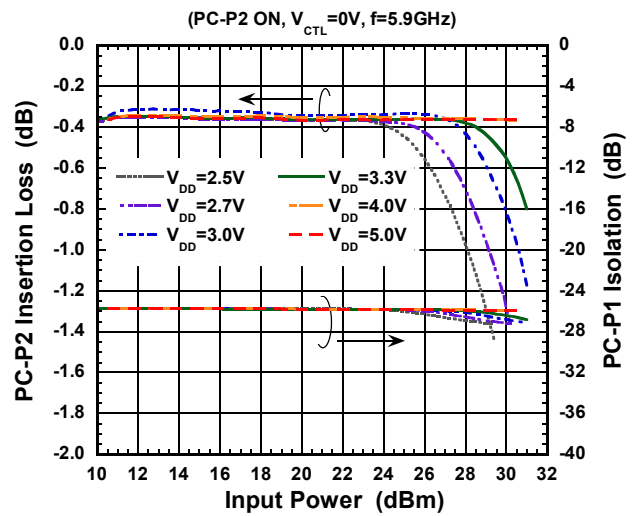

EVM vs Input Power

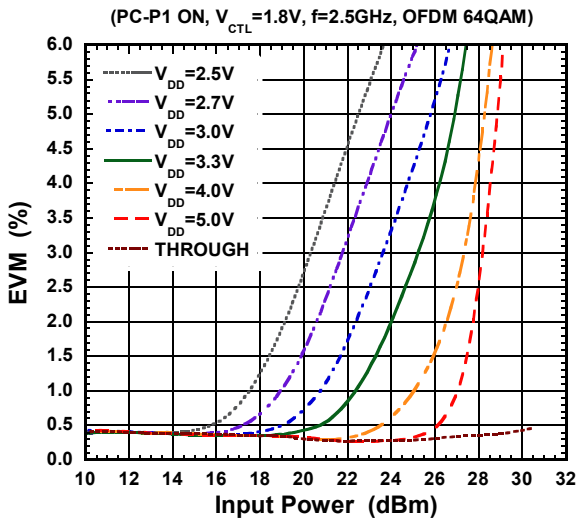

EVM vs Input Power

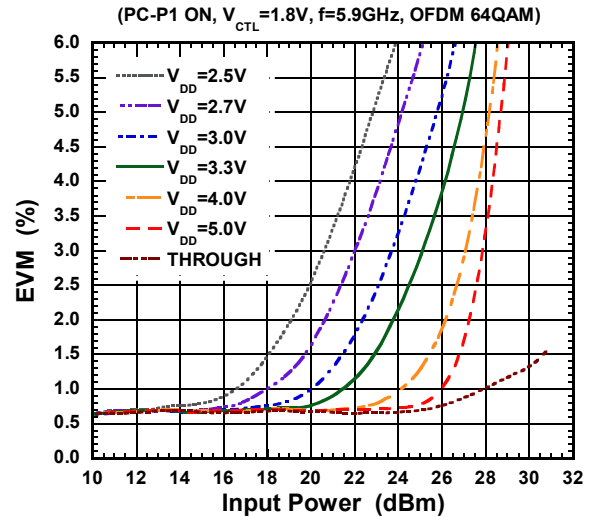

Switching Time

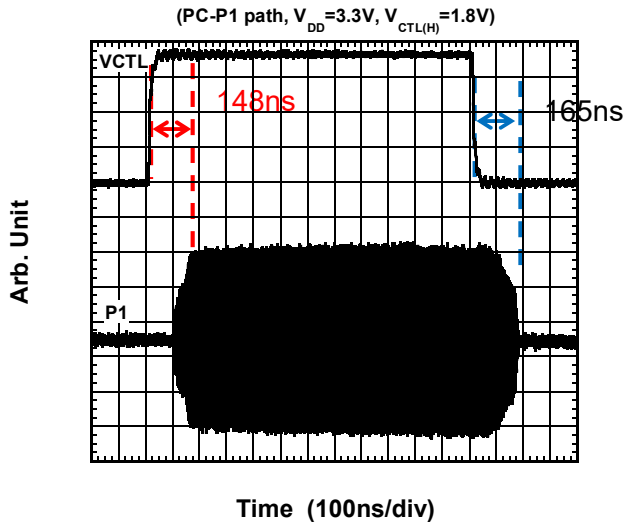

ELECTRICAL CHARACTERISTICS

General conditions: $V_{DD}=3.3V$, $V_{CTL}=1.8/0V$, $Z_S=Z_I=50\Omega$, with application circuit

Loss, ISL vs Temperature

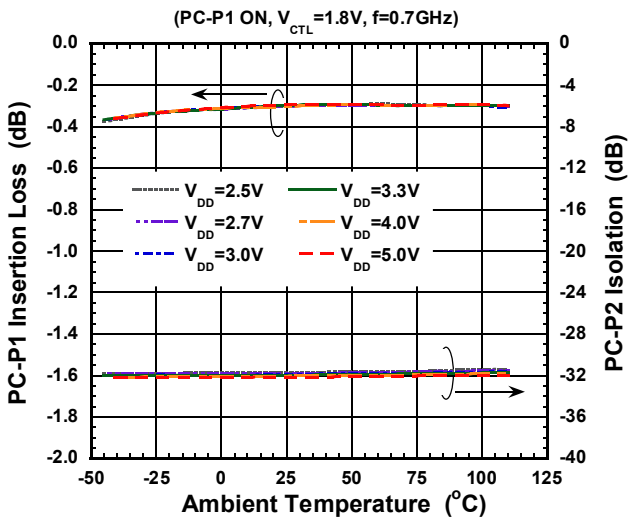

Loss, ISL vs Temperature

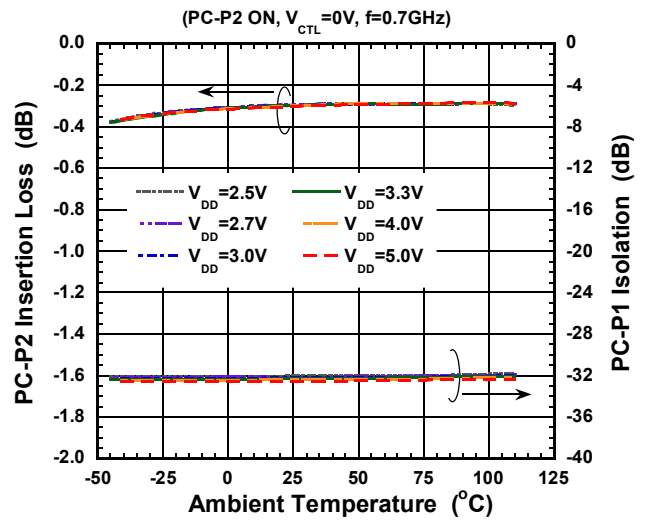

Loss, ISL vs Temperature

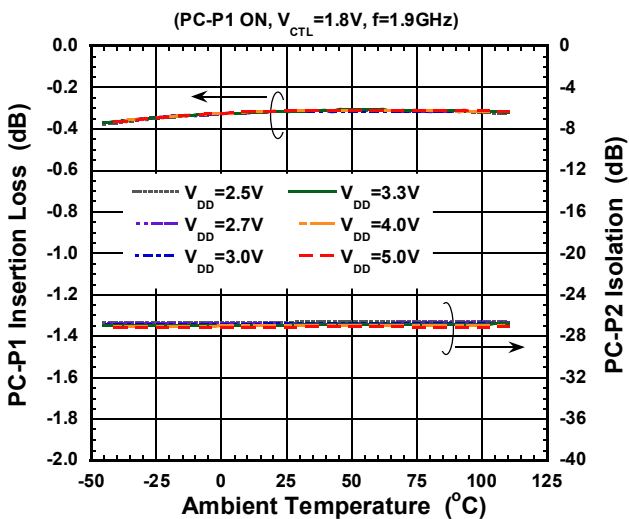

Loss, ISL vs Temperature

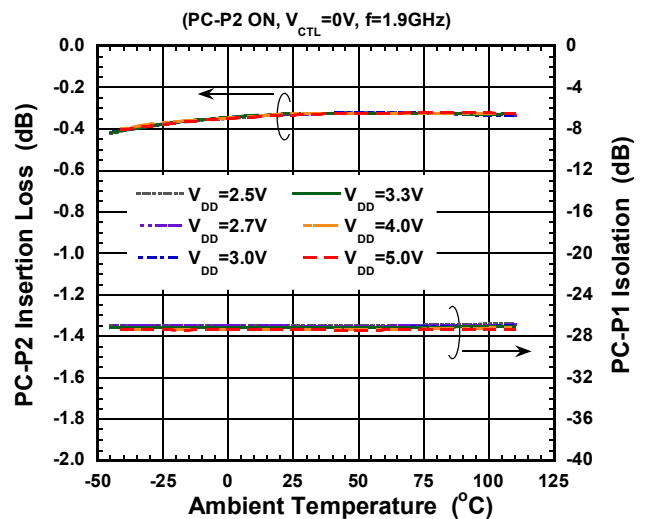

Loss, ISL vs Temperature

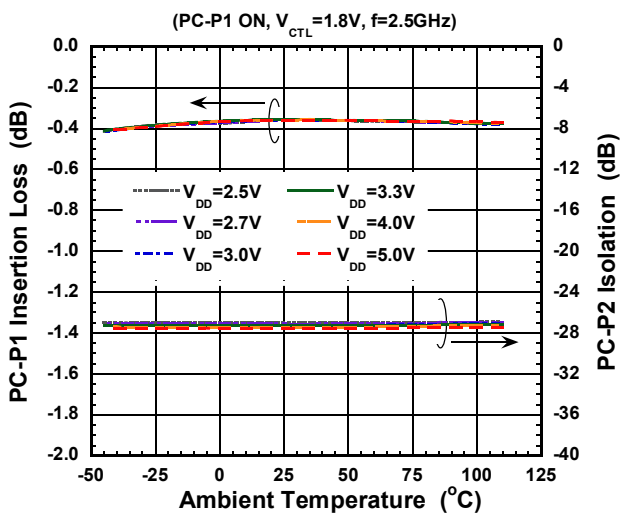

Loss, ISL vs Temperature

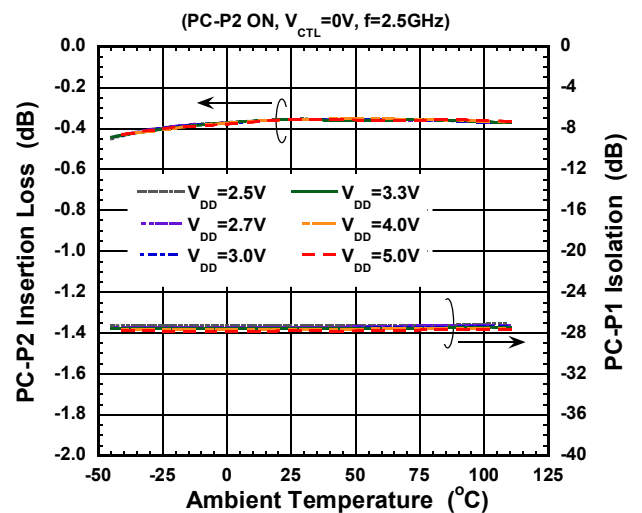

ELECTRICAL CHARACTERISTICS

General conditions: $V_{DD}=3.3V$, $V_{CTL}=1.8/0V$, $Z_S=Z_I=50\Omega$, with application circuit

Loss, ISL vs Temperature

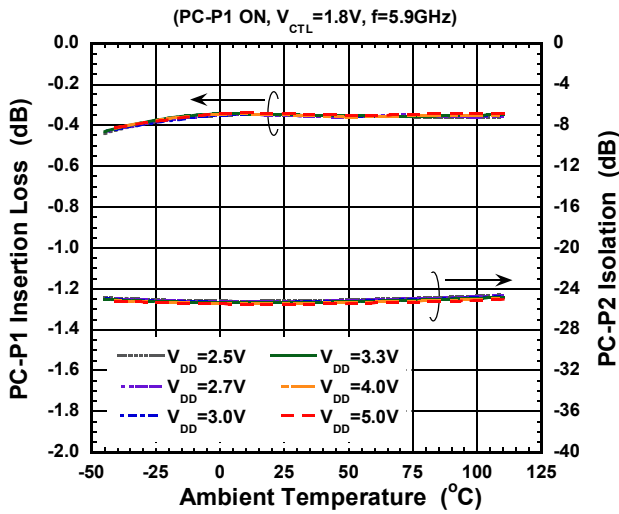

Loss, ISL vs Temperature

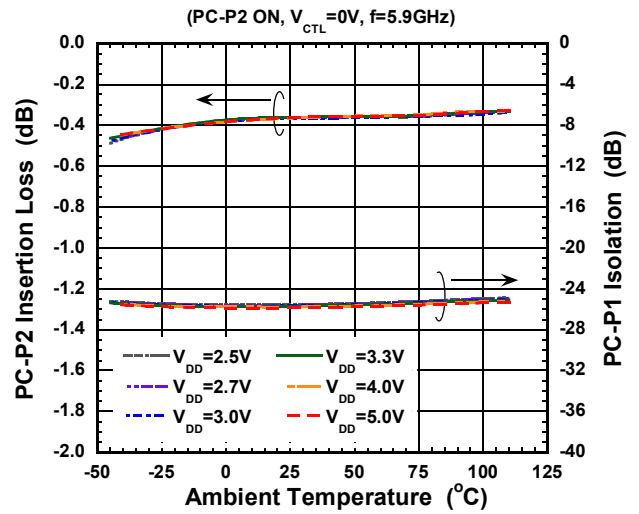

P_{-1dB} vs Temperature

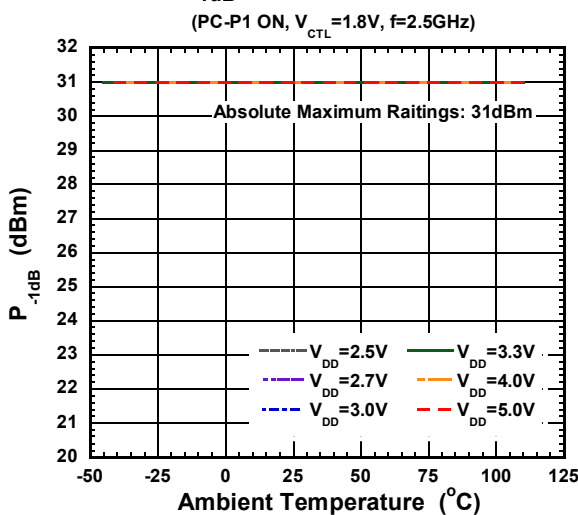

P_{-1dB} vs Temperature

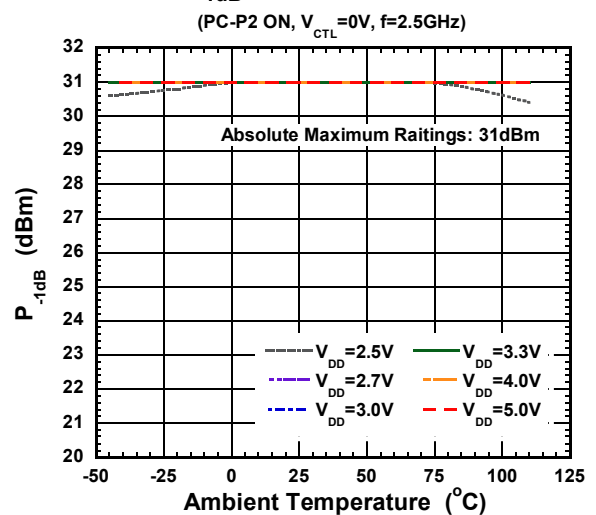

P_{-1dB} vs Temperature

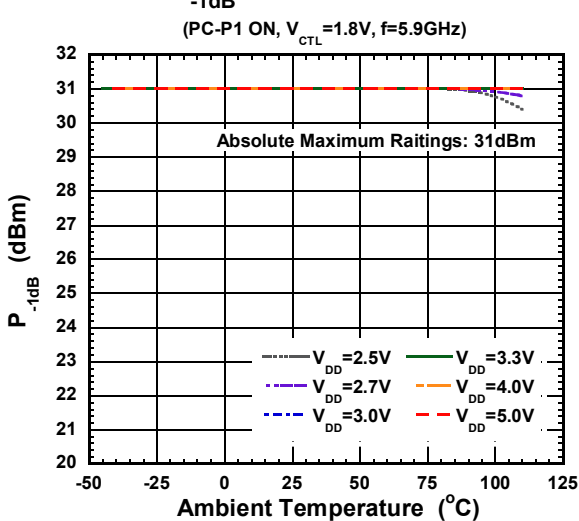

P_{-1dB} vs Temperature

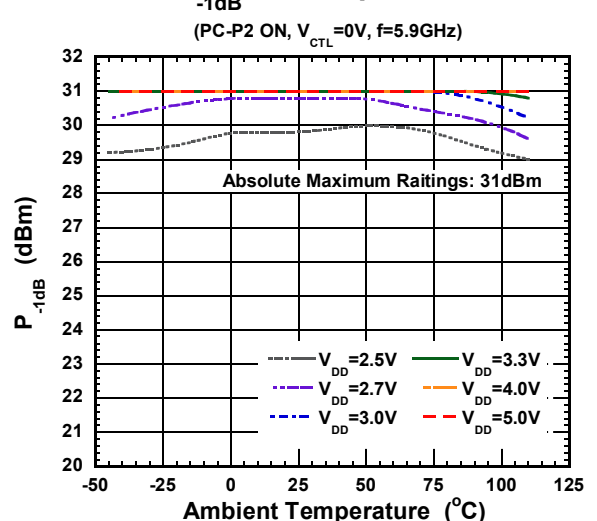

APPLICATION CIRCUIT

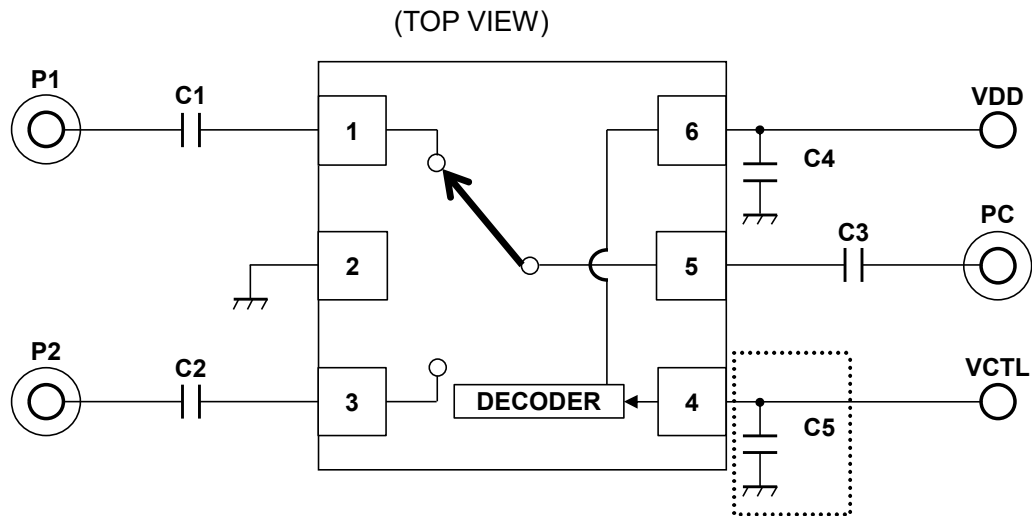

NOTE:

The bypass capacitor, C5 is optional, and is recommended only when the control line is affected under noisy environment.

PARTS LIST

Parts No.	Value		Notes
	Frequency range 0.7~2.0GHz	Frequency range 2.0~5.9GHz	
C1 to C3	56pF	27pF	Murata MFG (GRM03 series)
C4	1000pF	1000pF	
C5	10pF	10pF	

RECOMMENDED PCB DESIGN

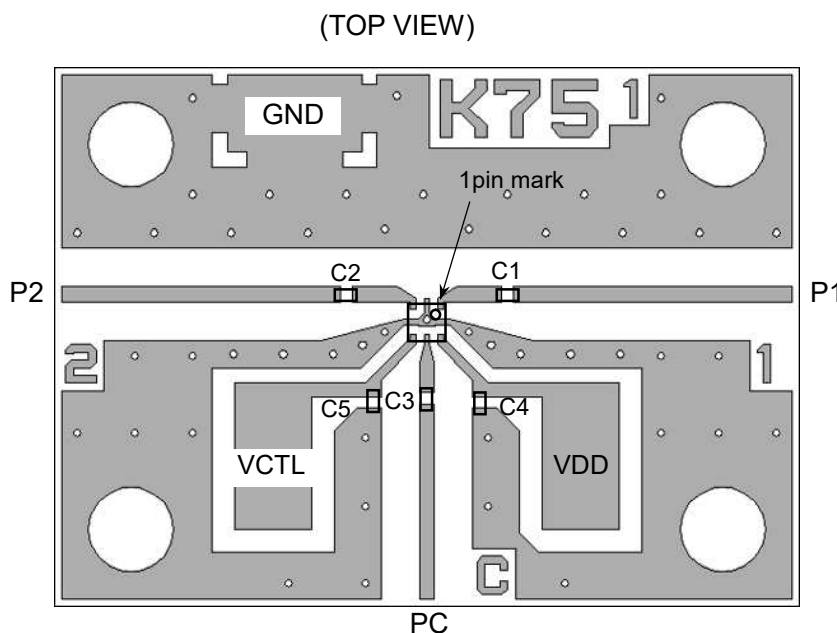

PCB: FR-4, t=0.2mm
 Capacitor Size: 0603 (0.6 x 0.3 mm)
 Strip Line Width: 0.4mm
 PCB Size: 19.4 x 14.0mm
 Through Hole Diameter: 0.2mm

Loss of PCB, capacitor and connectors

Frequency (GHz)	Loss (dB)
0.7	0.15
1.9	0.26
2.4	0.30
2.5	0.31
4.9	0.59
5.9	0.71

■ PCB LAYOUT GUIDELINE

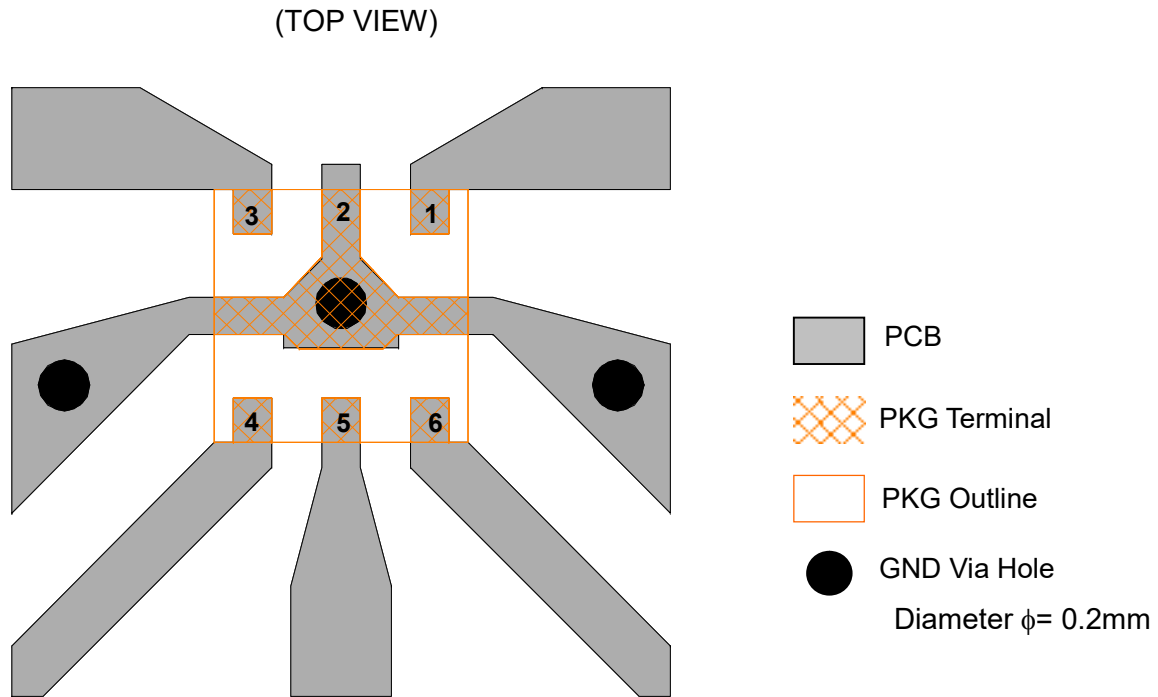

PRECAUTIONS

- [1] The DC blocking capacitors should be placed at RF terminals. Please choose appropriate capacitance value at the application frequency.
- [2] For good RF performance, exposed pad should be connected to PCB ground plane as close as possible.

RECOMMENDED FOOTPRINT PATTERN (6pin DFN Package 1.0x1.0mm) <Reference>

Package: 1.0mm x 1.0mm

Pin pitch: 0.35mm

 : Land

 : Mask (Open area) *Metal mask thickness: 100μm

 : Resist (Open area)

Unit : mm

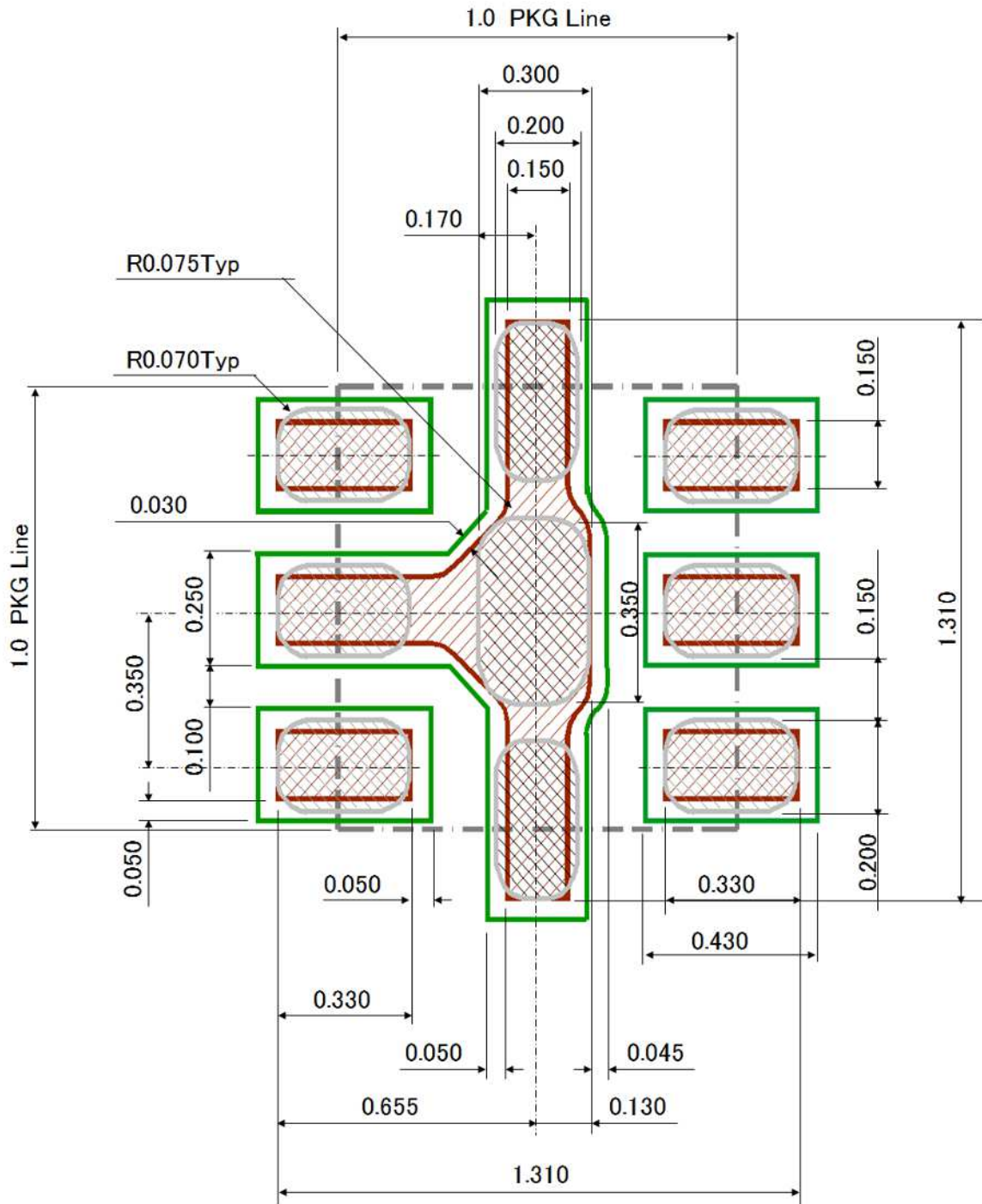

PACKAGE OUTLINE (DFN6-75)

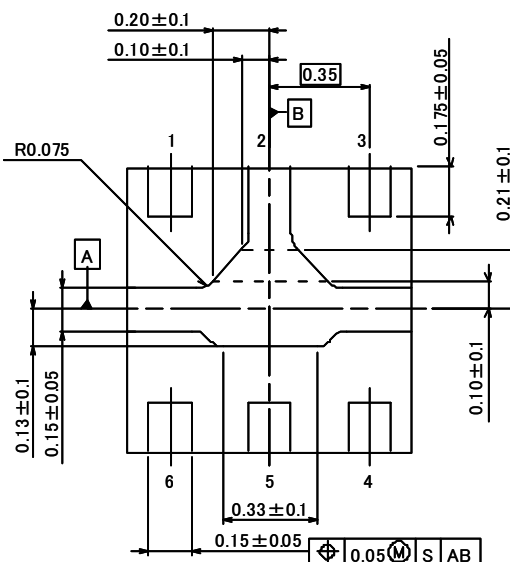
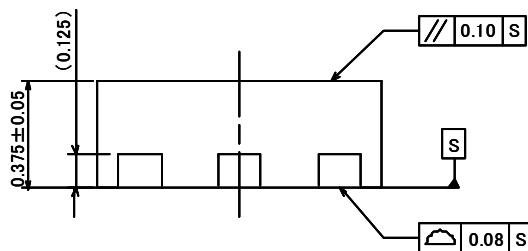
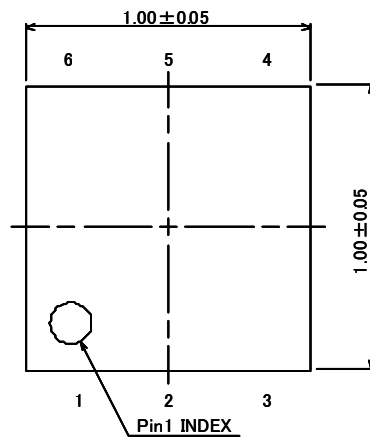

Unit	:	mm
Board	:	Cu
Terminal Treat	:	Ni/Pd/Au
Molding Material	:	Epoxy resin
Weight	:	1.2mg

Cautions on using this product

- This product contains Gallium-Arsenide (GaAs) which is a harmful material.
- Do NOT eat or put into mouth.
 - Do NOT dispose in fire or break up this product.
 - Do NOT chemically make gas or powder with this product.
 - To waste this product, please obey the relating law of your country.

[CAUTION]

The specifications on this databook are only given for information, without any guarantee as regards either mistakes or omissions. The application circuits in this databook are described only to show representative usages of the product and not intended for the guarantee or permission of any right including the industrial rights.

This product may be damaged with electric static discharge (ESD) or spike voltage. Please handle with care to avoid these damages.

1. The products and the product specifications described in this document are subject to change or discontinuation of production without notice for reasons such as improvement. Therefore, before deciding to use the products, please refer to our sales representatives for the latest information thereon.
2. The materials in this document may not be copied or otherwise reproduced in whole or in part without the prior written consent of us.
3. This product and any technical information relating thereto are subject to complementary export controls (so-called KNOW controls) under the Foreign Exchange and Foreign Trade Law, and related politics ministerial ordinance of the law. (Note that the complementary export controls are inapplicable to any application-specific products, except rockets and pilotless aircraft, that are insusceptible to design or program changes.) Accordingly, when exporting or carrying abroad this product, follow the Foreign Exchange and Foreign Trade Control Law and its related regulations with respect to the complementary export controls.
4. The technical information described in this document shows typical characteristics and example application circuits for the products. The release of such information is not to be construed as a warranty of or a grant of license under our or any third party's intellectual property rights or any other rights.
5. The products listed in this document are intended and designed for use as general electronic components in standard applications (office equipment, telecommunication equipment, measuring instruments, consumer electronic products, amusement equipment etc.). Those customers intending to use a product in an application requiring extreme quality and reliability, for example, in a highly specific application where the failure or misoperation of the product could result in human injury or death should first contact us.
 - Aerospace Equipment
 - Equipment Used in the Deep Sea
 - Power Generator Control Equipment (nuclear, steam, hydraulic, etc.)
 - Life Maintenance Medical Equipment
 - Fire Alarms / Intruder Detectors
 - Vehicle Control Equipment (automotive, airplane, railroad, ship, etc.)
 - Various Safety Devices
 - Traffic control system
 - Combustion equipment

In case your company desires to use this product for any applications other than general electronic equipment mentioned above, make sure to contact our company in advance. Note that the important requirements mentioned in this section are not applicable to cases where operation requirements such as application conditions are confirmed by our company in writing after consultation with your company.

6. We are making our continuous effort to improve the quality and reliability of our products, but semiconductor products are likely to fail with certain probability. In order to prevent any injury to persons or damages to property resulting from such failure, customers should be careful enough to incorporate safety measures in their design, such as redundancy feature, fire containment feature and fail-safe feature. We do not assume any liability or responsibility for any loss or damage arising from misuse or inappropriate use of the products.
7. The products have been designed and tested to function within controlled environmental conditions. Do not use products under conditions that deviate from methods or applications specified in this datasheet. Failure to employ the products in the proper applications can lead to deterioration, destruction or failure of the products. We shall not be responsible for any bodily injury, fires or accident, property damage or any consequential damages resulting from misuse or misapplication of the products.
8. **Quality Warranty**
 - 8-1. **Quality Warranty Period**

In the case of a product purchased through an authorized distributor or directly from us, the warranty period for this product shall be one (1) year after delivery to your company. For defective products that occurred during this period, we will take the quality warranty measures described in section 8-2. However, if there is an agreement on the warranty period in the basic transaction agreement, quality assurance agreement, delivery specifications, etc., it shall be followed.
 - 8-2. **Quality Warranty Remedies**

When it has been proved defective due to manufacturing factors as a result of defect analysis by us, we will either deliver a substitute for the defective product or refund the purchase price of the defective product.

Note that such delivery or refund is sole and exclusive remedies to your company for the defective product.
 - 8-3. **Remedies after Quality Warranty Period**

With respect to any defect of this product found after the quality warranty period, the defect will be analyzed by us. On the basis of the defect analysis results, the scope and amounts of damage shall be determined by mutual agreement of both parties. Then we will deal with upper limit in Section 8-2. This provision is not intended to limit any legal rights of your company.
9. Anti-radiation design is not implemented in the products described in this document.
10. The X-ray exposure can influence functions and characteristics of the products. Confirm the product functions and characteristics in the evaluation stage.
11. WLCSP products should be used in light shielded environments. The light exposure can influence functions and characteristics of the products under operation or storage.
12. Warning for handling Gallium and Arsenic (GaAs) products (Applying to GaAs MMIC, Photo Reflector). These products use Gallium (Ga) and Arsenic (As) which are specified as poisonous chemicals by law. For the prevention of a hazard, do not burn, destroy, or process chemically to make them as gas or power. When the product is disposed of, please follow the related regulation and do not mix this with general industrial waste or household waste.
13. Please contact our sales representatives should you have any questions or comments concerning the products or the technical information.



Nisshinbo Micro Devices Inc.

Official website

<https://www.nisshinbo-microdevices.co.jp/en/>

Purchase information

<https://www.nisshinbo-microdevices.co.jp/en/buy/>

1. The products and the product specifications described in this document are subject to change or discontinuation of production without notice for reasons such as improvement. Therefore, before deciding to use the products, please refer to our sales representatives for the latest information thereon.
2. The materials in this document may not be copied or otherwise reproduced in whole or in part without the prior written consent of us.
3. This product and any technical information relating thereto are subject to complementary export controls (so-called KNOW controls) under the Foreign Exchange and Foreign Trade Law, and related politics ministerial ordinance of the law. (Note that the complementary export controls are inapplicable to any application-specific products, except rockets and pilotless aircraft, that are insusceptible to design or program changes.) Accordingly, when exporting or carrying abroad this product, follow the Foreign Exchange and Foreign Trade Control Law and its related regulations with respect to the complementary export controls.
4. The technical information described in this document shows typical characteristics and example application circuits for the products. The release of such information is not to be construed as a warranty of or a grant of license under our or any third party's intellectual property rights or any other rights.
5. The products listed in this document are intended and designed for use as general electronic components in standard applications (office equipment, telecommunication equipment, measuring instruments, consumer electronic products, amusement equipment etc.). Those customers intending to use a product in an application requiring extreme quality and reliability, for example, in a highly specific application where the failure or misoperation of the product could result in human injury or death should first contact us.
 - Aerospace Equipment
 - Equipment Used in the Deep Sea
 - Power Generator Control Equipment (nuclear, steam, hydraulic, etc.)
 - Life Maintenance Medical Equipment
 - Fire Alarms / Intruder Detectors
 - Vehicle Control Equipment (automotive, airplane, railroad, ship, etc.)
 - Various Safety Devices
 - Traffic control system
 - Combustion equipment

In case your company desires to use this product for any applications other than general electronic equipment mentioned above, make sure to contact our company in advance. Note that the important requirements mentioned in this section are not applicable to cases where operation requirements such as application conditions are confirmed by our company in writing after consultation with your company.

6. We are making our continuous effort to improve the quality and reliability of our products, but semiconductor products are likely to fail with certain probability. In order to prevent any injury to persons or damages to property resulting from such failure, customers should be careful enough to incorporate safety measures in their design, such as redundancy feature, fire containment feature and fail-safe feature. We do not assume any liability or responsibility for any loss or damage arising from misuse or inappropriate use of the products.
7. The products have been designed and tested to function within controlled environmental conditions. Do not use products under conditions that deviate from methods or applications specified in this datasheet. Failure to employ the products in the proper applications can lead to deterioration, destruction or failure of the products. We shall not be responsible for any bodily injury, fires or accident, property damage or any consequential damages resulting from misuse or misapplication of the products.
8. **Quality Warranty**
 - 8-1. **Quality Warranty Period**

In the case of a product purchased through an authorized distributor or directly from us, the warranty period for this product shall be one (1) year after delivery to your company. For defective products that occurred during this period, we will take the quality warranty measures described in section 8-2. However, if there is an agreement on the warranty period in the basic transaction agreement, quality assurance agreement, delivery specifications, etc., it shall be followed.
 - 8-2. **Quality Warranty Remedies**

When it has been proved defective due to manufacturing factors as a result of defect analysis by us, we will either deliver a substitute for the defective product or refund the purchase price of the defective product.

Note that such delivery or refund is sole and exclusive remedies to your company for the defective product.
 - 8-3. **Remedies after Quality Warranty Period**

With respect to any defect of this product found after the quality warranty period, the defect will be analyzed by us. On the basis of the defect analysis results, the scope and amounts of damage shall be determined by mutual agreement of both parties. Then we will deal with upper limit in Section 8-2. This provision is not intended to limit any legal rights of your company.
9. Anti-radiation design is not implemented in the products described in this document.
10. The X-ray exposure can influence functions and characteristics of the products. Confirm the product functions and characteristics in the evaluation stage.
11. WLCSP products should be used in light shielded environments. The light exposure can influence functions and characteristics of the products under operation or storage.
12. Warning for handling Gallium and Arsenic (GaAs) products (Applying to GaAs MMIC, Photo Reflector). These products use Gallium (Ga) and Arsenic (As) which are specified as poisonous chemicals by law. For the prevention of a hazard, do not burn, destroy, or process chemically to make them as gas or power. When the product is disposed of, please follow the related regulation and do not mix this with general industrial waste or household waste.
13. Please contact our sales representatives should you have any questions or comments concerning the products or the technical information.



Nisshinbo Micro Devices Inc.

Official website

<https://www.nisshinbo-microdevices.co.jp/en/>

Purchase information

<https://www.nisshinbo-microdevices.co.jp/en/buy/>