

Aluminium Housed Power Resistors

Type THS Series

Type THS Series



Tyco are the leading European supplier of standard and custom designed aluminium housed resistors for general-purpose use, power supplies, power generation and the traction industry. The THS is a range of extremely stable, high quality wire wound resistors capable of dissipating high power in a limited space with relatively low surface temperature. The power is rapidly dissipated as heat through the aluminium housing to a specified heatsink. The resistors are made from quality materials for optimum reliability and stability. Tyco can test resistors to conform to relevant international, MIL or customer specifications.

Key Features

- Established product with proven reliability
 - Leading the way with over 50 years of design and manufacturing experience
- 10 Watts to 75 Watts
- Versatile product
 - Bench mark in every industry

Applications

- Braking Resistor
- Balancing Resistor
- Capacitor Charging & Discharging
- Crowbar
- Filter
- Electrical Machinery general use
- Available through Distribution

Characteristics - Electrical THS - 10 Watts to 75 Watts

	THS10	THS15	THS25	THS50	THS75
Dissipation @ 25°C with Heatsink (Watts):	10	15	25	50	75
Without Heatsink:	5.5	8	12.5	20	40
Ohmic Value Min (Ohms):	R01	R01	R01	R01	R05
Max:	10K	15K	36K	50K	50K
Max. Working Voltage (DC or ACrms) Volts:	160	265	550	1250	1400
Dielectric Strength (AC Peak) Volts:	1400	1400	2500	2500	5000
Stability (% resistance change, 1000 hours) (%):	1	1	1	1	2
Standard Heatsink - Area (mm ²):	41500	41500	53500	53500	99500
Thickness (mm):	1	1	1	1	3
Number of Mounting Holes:	2 hole	2 hole	2 hole	2 hole	4 hole

Characteristics - Electrical

Long Term Stability:	For improvements in long-term stability, resistors must be derated as follows; for 50% of stated ΔR maximum dissipation must not exceed 70% of rating; for 25% of stated ΔR maximum, dissipation must not exceed 50% of rating
Insulation Resistance:	Dry: 10,000M Ω minimum. After moisture test: 1000M Ω minimum.
Heat Dissipation:	Although the use of proprietary heat sinks with lower thermal resistance is acceptable, up rating is not recommended. The use of proprietary heat sink compound to improve thermal conductivity is recommended for optimum performance of all sizes
Specification:	Temperature coefficient below 100R, 50ppm/ $^{\circ}$ C Temperature coefficient above 100R, 30ppm/ $^{\circ}$ C Tolerance, 5% standard

Product Specifications - THS10 - THS75

Type	L
THS10, 15	7
THS25, 50	10
THS75	8

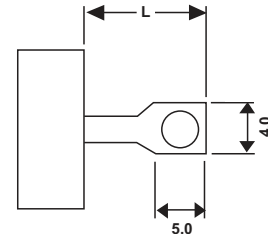

Dimensions - THS10 - THS50

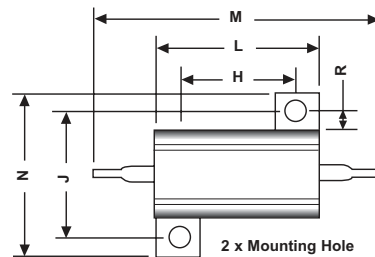

THS10 - 2.4mm THS25 - 3.3mm
THS15 - 2.4mm THS50 - 3.3mm

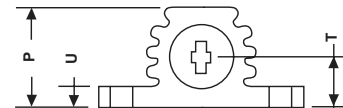

Type	H \pm 0.3	J \pm 0.3	L Max	M Max	N Max	P Max	R Min	T \pm 0.5	U Max
THS10	11.3	12.4	17.0	30.0	17.0	9.0	1.9	3.4	2.5
THS15	14.3	15.9	21.0	36.5	21.0	11.0	1.9	5.2	3.2
THS25	18.3	19.8	29.0	51.8	28.0	15.0	2.8	7.2	3.2
THS50	39.7	21.4	51.0	72.5	30.0	17.0	2.8	7.9	3.2

Type THS Series

Dimensions - THS75

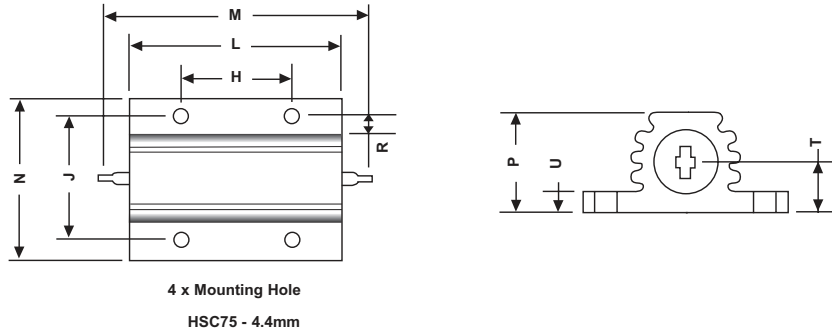

Type	H±0.3	J±0.3	K±0.2	L Max	M Max	N Max	P Max	R Min	T±0.5	U Max
THS75	29.0	37.0	4.4	49.0	71.0	47.5	26.0	5.0	11.5	3.5

Derating Curve THS10 to THS75

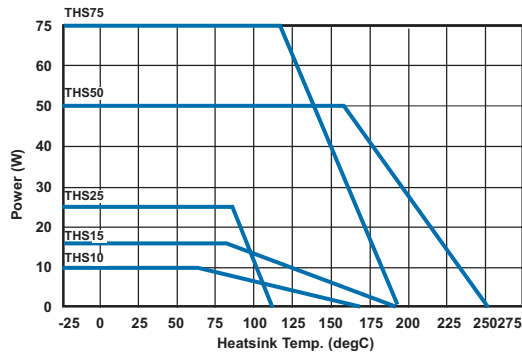

Pulse Energy THS10 to THS75

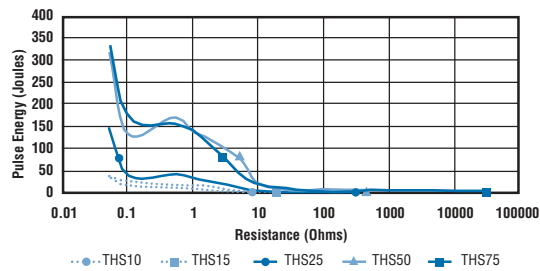

Type THS Series

Power Overload

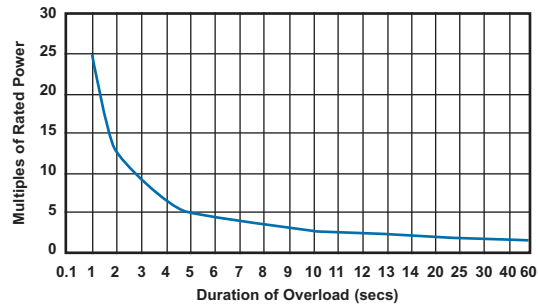

This graph indicates the amount that the rated power (at 20°C) of the standard HS Series resistor may be increased for overloads of 100mS to 60S

Surface Temperature Rise

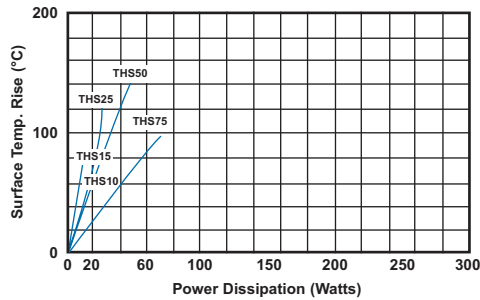

For resistor mounted on standard heatsink, related to power dissipation

How to Order

THS	50	680R	J
Common Part	Power Rating	Resistance Value	Tolerance
THS- Standard NTHS - Low Inductance	10 Watt = THS10 15 Watt = THS15 25 Watt = THS25 50 Watt = THS50 75 Watt = THS75	0.1ohm (100 mille ohms) R10 1ohm (1000 mille ohms) 1R0 1K (1000 ohms) 1K0	J - 5%