



Features

- Triple Logic Voltage Outputs (*Independently Regulated!*)
- Input Voltage Range: 36V to 75V
- 1500VDC Isolation
- Over-Current Protection
- Over-Voltage Protection
- Over-Temperature Shutdown
- Under-Voltage Lockout
- Independently Adjustable Outputs
- Dual Logic On/Off Control
- Fixed Frequency Operation
- Solderable Space Saving Package: 1.97 sq. in. PCB Area (suffix N)
- IPC Lead Free 2
- Safety Approvals Pending:
 - UL60950
 - CSA 22.2 950
 - VDE EN60950

Description

The PT4850 Excalibur™ power modules are a series of isolated triple-output DC/DC converters that operate from a standard (-48V) central office supply. These modules are rated for a combined output of up to 25A, and were designed for powering mixed logic applications. The triple-output voltage provides a compact multiple-output power supply in a single DC/DC module.

Output voltage options include a low-voltage output for a DSP or ASIC core, and two additional supply voltages for the I/O, and other functions.

The PT4850 series incorporates many features to simplify system integration. These include a flexible On/Off enable control, input under-voltage lockout and over-temperature protection. All outputs are current limited and short-circuit protected, and are internally sequenced to meet the power-up and power-down requirements of popular DSP ICs.

The PT4850 series is housed in a space-saving solderable case. The module requires no external heat sink. Both vertical and horizontal pin configurations are available, including surface mount.

Ordering Information

- PT4851□ = +3.3/+2.5/+1.5V
- PT4852□ = +3.3/+1.8/+1.5V
- PT4853□ = +3.3/+2.5/+1.2V
- PT4854□ = +3.3/+1.8/+1.2V
- PT4855□ = +3.3/+1.5/+1.2V
- PT4856□ = +5.0/+3.3/+1.5V

PT Series Suffix (PT1234 x)

Case/Pin Configuration	Order Suffix	Package Code
Vertical	N	(EKD)
Horizontal	A	(EKA)
SMD	C	(EKC)

(Reference the applicable package code drawing for the dimensions and PC layout)

Standard Application

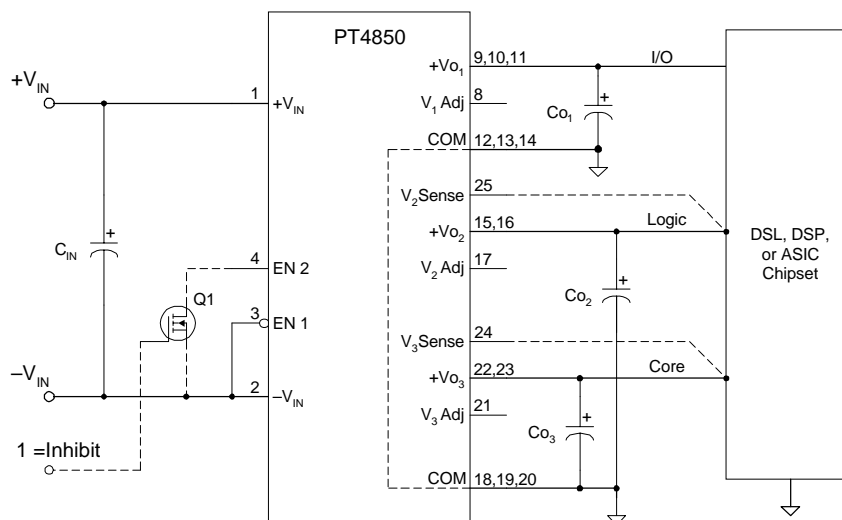

C_{in} = Optional
 Co₁, Co₂, Co₃ = Optional. See specifications
 EN1 & EN2 operation: See application notes

Environmental Specifications

Characteristics	Symbols	Conditions	Min	Typ	Max	Units
Operating Temperature Range	T_a	Over V_{in} Range	-40	—	+85 ⁽ⁱ⁾	°C
Case Temperature	T_c		—	—	105	°C
Storage Temperature	T_s	—	-40	—	+125	°C
Over Temperature Protection	OTP	Case temperature	—	110	125	°C
Mechanical Shock		Per Mil-STD-883D, Method 2002.3 1 msec, ½ Sine, mounted	—	500	—	G's
Mechanical Vibration		Mil-STD-883D, Method 2007.2 20-2000 Hz	—	10 ⁽ⁱⁱ⁾ 20 ⁽ⁱⁱ⁾	—	G's
Weight	—	Vertical/Horizontal	—	90	—	grams
Flammability	—	Meets UL 94V-O	—	—	—	—

Notes: (i) See SOA curves or consult factory for appropriate derating.

(ii) The case pins on through-hole pin configurations (N & A) must be soldered. For more information see the applicable package outline drawing.

Pin Configuration

Pin Function	Pin Function	Pin Function
1 +Vin	10 +Vo ₁	19 COM
2 -Vin	11 +Vo ₁	20 COM
3 EN 1	12 COM	21 Vo ₃ Adjust
4 EN 2	13 COM	22 +Vo ₃
5 TEMP	14 COM	23 +Vo ₃
6 Pin Not Present	15 +Vo ₂	24 Vo ₃ Rem Sense
7 Do Not Connect	16 +Vo ₂	25 Vo ₂ Rem Sense
8 Vo ₁ Adjust	17 Vo ₂ Adjust	26 Do Not Connect
9 +Vo ₁	18 COM	

Note: Shaded functions indicate those pins that are at primary-side potential.

On/Off Enable Logic

Pin 3	Pin 4	Output Status
1	×	Off
0	1	On
×	0	Off

Notes:

Logic 1 = Open circuit

Logic 0 = -Vin (pin 2) potential

For positive Enable function, connect pin 3 to pin 2 and use pin 4.

For negative Enable function, leave pin 4 open and use pin 3.

Pin Descriptions

+Vin: The positive input supply for the module with respect to -Vin. When powering the module from a -48V telecom central office supply, this input is connected to the primary system ground.

-Vin: The negative input supply for the module, and the 0VDC reference for the EN 1, and EN 2 inputs. When powering the module from a +48V supply, this input is connected to the 48V(Return).

EN 1: The negative logic input that activates the module output. This pin must be connected to -Vin to enable the module's outputs. A high impedance disables the module's outputs.

EN 2: The positive logic input that activates the module output. If not used, this pin should be left open circuit. Connecting this input to -Vin disables the module's outputs.

TEMP: This pin produces an output signal that tracks a temperature that is approximately the module's metal case. The output voltage is referenced to -Vin and rises approximately 10mV/°C from an initial value of 0.1VDC at -40°C. The signal is available whenever the module is supplied with a valid input voltage, and is independent of the enable logic status. (Note: A load impedance of less than 1MΩ will adversely

affect the module's over-temperature shutdown threshold. Use a high-impedance input when monitoring this signal.)

Vo 1: The highest regulated output voltage, which is referenced to the COM node.

Vo 2: The regulated output that is designed to power logic circuitry. It is referenced to the COM node.

Vo 3: The low-voltage regulated output that provides power for a μ-processor or DSP core, and is referenced to the COM node.

COM: The secondary return reference for the module's three regulated output voltages. It is DC isolated from the input supply pins.

Vo_(n) Adjust: Using a single resistor, this pin allows the associated output Vo_(n) to be adjusted higher or lower than the preset value. If not used, this pin should be left open circuit.

Vo_(n) Rem Sense: An external remote sense input is provided for the two lowest voltage outputs, +Vo₂ and +Vo₃. Connecting the remote sense pins improves the load regulation of the applicable output by allowing the regulation circuit to compensate for voltage drop between the converter and load. If desired these inputs may be left disconnected.

Electrical Specifications (Unless otherwise stated, the operating conditions are:- $T_a = 25^\circ\text{C}$, $V_{in} = 48\text{V}$, and $I_o = 0.5I_{o,max}$)

Characteristics	Symbols	Conditions	PT4850 Series (Except PT4856)			Units	
			Min	Typ	Max		
Output Current	I_o	Each output	I_{o1}	0	—	15	A
			I_{o2}	0	—	10	
			I_{o3}	0	—	10	
	$I_{o,tot}$	Total (all three outputs)	—	—	25	A	
Input Voltage Range	V_{in}	Continuous		36	—	75	V
			Surge (1 minute)	—	—	80	
Set-Point Voltage Tolerance	$V_{o,tol}$		—	—	1.5	% V_o	
Temperature Variation	ΔReg_{temp}	$-40^\circ\text{C} \leq T_a \leq +85^\circ\text{C}$, $I_{o1} = I_{o2} = I_{o3} = I_{o,min}$	—	± 0.5	—	% V_o	
Line Regulation	ΔReg_{line}	All outputs, Over V_{in} range	—	± 0.2	± 0.5	% V_o	
Load Regulation	ΔReg_{load}	Each output, $0 \leq I_o \leq I_{o,max}$	—	± 5	± 10	mV	
Cross Regulation	ΔReg_{cross}	Any output vs. another	—	—	± 10	mV	
Total Output Voltage Variation	$\Delta V_o, tol$	Includes set-point, line, load, $-40^\circ\text{C} \leq T_a \leq +85^\circ\text{C}$	—	± 2	± 3 (1)	% V_o	
Efficiency	η	$I_{o1} = 10\text{A}$, $I_{o2} = 5\text{A}$, $I_{o3} = 5\text{A}$	—	85	—	%	
V_o Ripple (pk-pk)	V_r	20MHz bandwidth, $I_{o1} = I_{o2} = I_{o3} = 5\text{A}$	$V_o = 5.0\text{V}$	—	50	75	mV _{pp}
			$V_o = 3.3\text{V}$	—	20	50	
			$V_o = 1.8\text{V}/2.5\text{V}$	—	20	30	
			$V_o \leq 1.5\text{V}$	—	15	25	
Transient Response	t_{tr} V_{os}	0.1A/ μs load step, 50% to 75% $I_{o,max}$ V_o over/undershoot		—	200	—	μSec % V_o
				—	5	—	
Output Adjust Range	$V_{o,adj}$	$V_{o1}/V_{o2}/V_{o3}$	—	± 10	—	% V_o	
Current Limit Threshold	I_{LIM}	$\Delta V_o = -1\%$	V_{o1} V_{o2} V_{o3}	— — —	20 15 15	— — —	A
Output Over-Voltage Protection	OVP	All outputs; module shutdown and latch off	—	125 (2)	—	% V_o	
Switching Frequency	f_s	Over V_{in} and I_o ranges	280	320	340	kHz	
Under Voltage Lockout	V_{on} V_{off}	V_{in} increasing V_{in} decreasing		—	34	36	V
				30	32	—	
Enable Control (pins 3 & 4)	V_{IH} V_{IL} I_{IL}	Referenced to $-V_{in}$ (pin 2)		3.5	—	Open (3)	V
				-0.2	—	0.8 (3)	
				—	0.5	—	—
Standby Input Current	$I_{in, standby}$	pins 3 & 4 open circuit	—	2.5	4 (1)	mA	
Internal Input Capacitance	C_{int}		—	2	—	μF	
External Output Capacitance	C_{out}	Per each output	0	—	5,000	μF	
Primary/Secondary Isolation	V_{iso} C_{iso} R_{iso}			1500	—	—	V
				—	2,200	—	pF
				10	—	—	M Ω
Temperature Sense	V_{temp}	Output voltage at temperatures:-	-40°C	—	0.1 (4)	—	V
			100°C	—	1.5 (4)	—	

Notes: (1) Limits are specified by design.

(2) This is a fixed parameter. Adjusting V_{o1} or V_{o2} higher will increase the module's sensitivity to over-voltage detection. For more information, see the application note on output voltage adjustment.

(3) The Enable inputs (pins 3 & 4) have internal pull-ups. Leaving pin 4 open-circuit and connecting pin 3 to $-V_{in}$ (pin 2) allows the the converter to operate when input power is applied. The maximum open-circuit voltage for the Enable inputs is 5.4V.

(4) Voltage output at "TEMP" pin is defined by the equation:- $V_{TEMP} = 0.5 + 0.01 \cdot T$, where T is in $^\circ\text{C}$. See pin descriptions for more information.

PT4851 Performance Characteristics (See Note A)
($I_{o1} = 10A, I_{o2} = 7.5A, I_{o3} = 7.5A$ represents 100% Load)

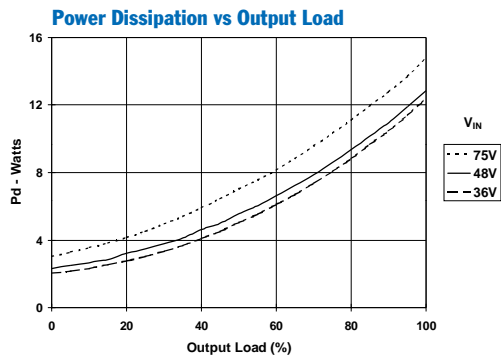
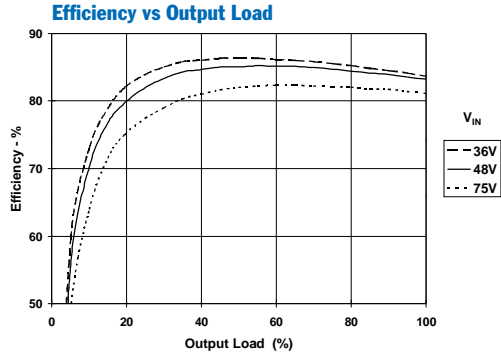

PT4851 Safe operating Area Curves (See Note B)
($I_{o1} + I_{o2} + I_{o3} = 25A$, represents 100% load)

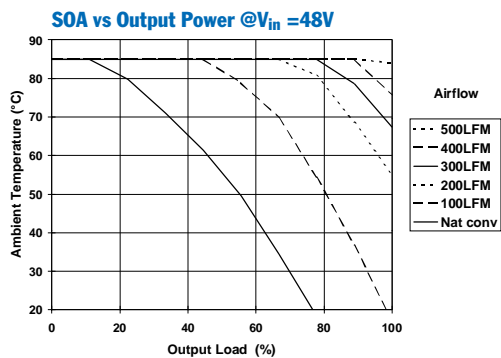

PT4852 Performance Characteristics (See Note A)
($I_{o1} = 10A, I_{o2} = 7.5A, I_{o3} = 7.5A$ represents 100% Load)

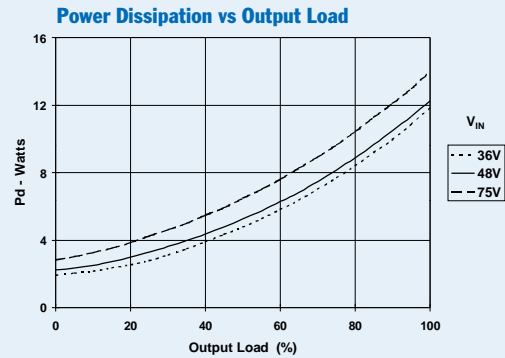
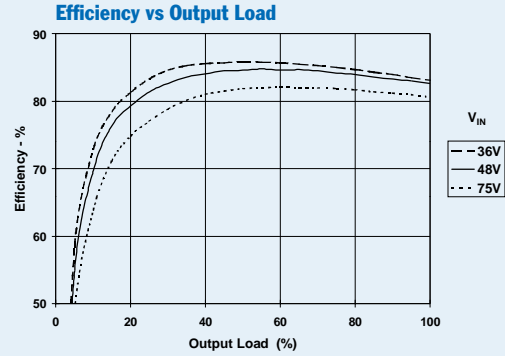

PT4852 Safe operating Area Curves (See Note B)
($I_{o1} + I_{o2} + I_{o3} = 25A$, represents 100% load)

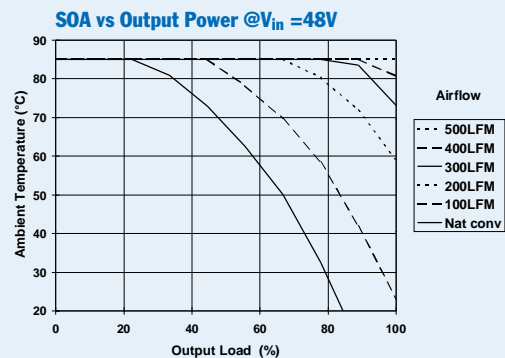

Note A: All Characteristic data in the above graphs has been developed from actual products tested at 25°C. This data is considered typical data for the ISR.

Note B: SOA curves represent operating conditions at which the internal components are at or below the manufacturer's maximum rated operating temperatures.

PT4853 Performance Characteristics (See Note A)
($I_{o1} = 10A, I_{o2} = 7.5A, I_{o3} = 7.5A$ represents 100% Load)

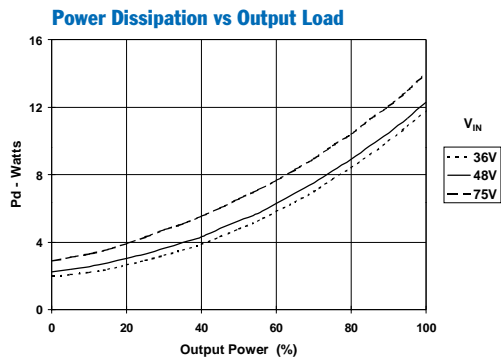
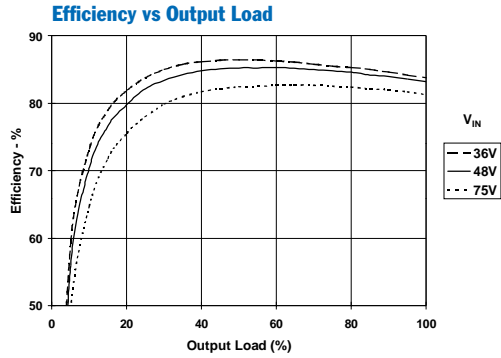

PT4853 Safe operating Area Curves (See Note B)
($I_{o1} + I_{o2} + I_{o3} = 25A$, represents 100% load)

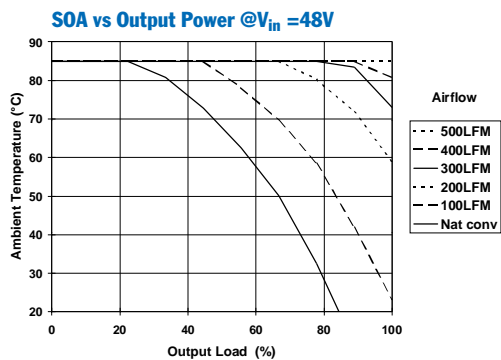

PT4854 Performance Characteristics (See Note A)
($I_{o1} = 10A, I_{o2} = 7.5A, I_{o3} = 7.5A$ represents 100% Load)

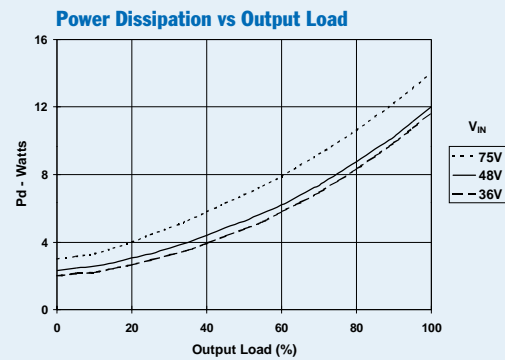
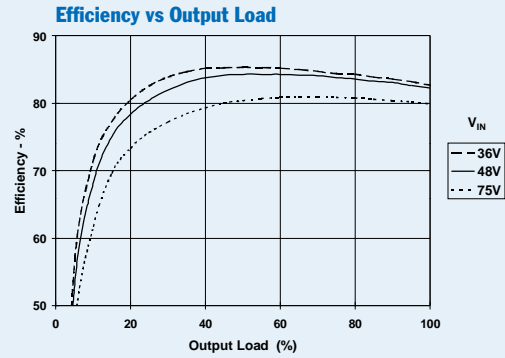

PT4854 Safe operating Area Curves (See Note B)
($I_{o1} + I_{o2} + I_{o3} = 25A$, represents 100% load)

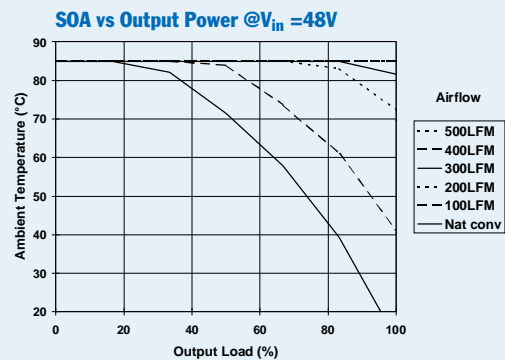

Note A: All Characteristic data in the above graphs has been developed from actual products tested at 25°C. This data is considered typical data for the ISR.
Note B: SOA curves represent operating conditions at which the internal components are at or below the manufacturer's maximum rated operating temperatures.

PT4855 Performance Characteristics (See Note A)
($I_{o1} = 10A, I_{o2} = 7.5A, I_{o3} = 7.5A$ represents 100% Load)

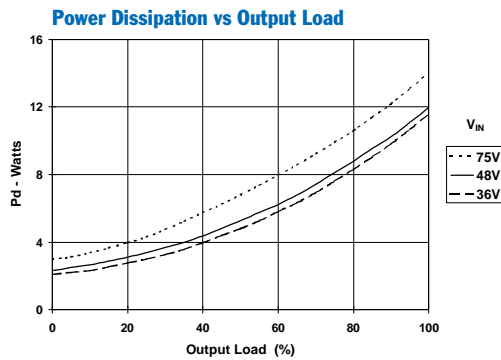
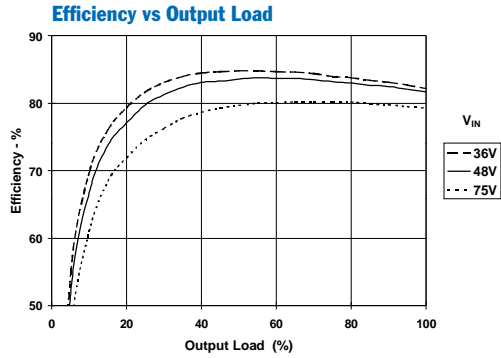

PT4855 Safe operating Area Curves (See Note B)
($I_{o1} + I_{o2} + I_{o3} = 25A$, represents 100% load)

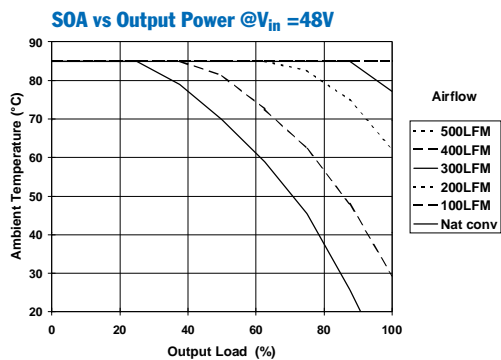

Note A: All Characteristic data in the above graphs has been developed from actual products tested at 25°C. This data is considered typical data for the ISR.
Note B: SOA curves represent operating conditions at which the internal components are at or below the manufacturer's maximum rated operating temperatures.

PT4856 Electrical Specifications (Unless otherwise stated, the operating conditions are:- $T_a = 25^\circ\text{C}$, $V_{in} = 48\text{V}$, and $I_o = 0.5I_{o,max}$)

Characteristics	Symbols	Conditions	PT4856 (Only)			Units	
			Min	Typ	Max		
Output Current	I_o	Each output	I_{o1}	0	—	10	A
			I_{o2} I_{o3}	0 0	— —	10 10	
	$I_{o,tot}$	Total (all three outputs)	—	—	25	A	
Input Voltage Range	V_{in}	Continuous Surge (1 minute)		36	—	75	V
				—	—	80	
Set-Point Voltage Tolerance	$V_{o,tol}$		—	—	1.5	% V_o	
Temperature Variation	ΔReg_{temp}	$-40^\circ\text{C} \leq T_a \leq +85^\circ\text{C}$, $I_{o1} = I_{o2} = I_{o3} = I_{o,min}$	—	± 0.5	—	% V_o	
Line Regulation	ΔReg_{line}	All outputs, Over V_{in} range	—	± 0.2	± 0.5	% V_o	
Load Regulation	ΔReg_{load}	Each output, $0 \leq I_o \leq I_{o,max}$	—	± 5	± 10	mV	
Cross Regulation	ΔReg_{cross}	Any output vs. another	—	—	± 10	mV	
Total Output Voltage Variation	$\Delta V_o, tol$	Includes set-point, line, load, $-40^\circ\text{C} \leq T_a \leq +85^\circ\text{C}$	—	± 2	± 3 (1)	% V_o	
Efficiency	η	$I_{o1} = 7\text{A}$, $I_{o2} = 5\text{A}$, $I_{o3} = 5\text{A}$	—	88	—	%	
V_o Ripple (pk-pk)	V_r	20MHz bandwidth, $I_{o1} = I_{o2} = I_{o3} = 5\text{A}$	$V_o = 5.0\text{V}$	—	50	75	mV _{pp}
			$V_o = 3.3\text{V}$	—	20	50	
			$V_o = 1.5\text{V}$	—	15	25	
Transient Response	t_{tr} V_{os}	0.1A/ μs load step, 50% to 75% $I_{o,max}$ V_o over/undershoot		—	200	—	μSec % V_o
				—	5	—	
Output Adjust Range	V_o, adj		$V_{o1}/V_{o2}/V_{o3}$	—	± 10	—	% V_o
Current Limit Threshold	I_{LIM}	$\Delta V_o = -1\%$	V_{o1}	—	20	—	A
			V_{o2}	—	15	—	
			V_{o3}	—	15	—	
Output Over-Voltage Protection	OVP	All outputs; module shutdown and latch off	—	125 (2)	—	% V_o	
Switching Frequency	f_s	Over V_{in} and I_o ranges	280	320	340	kHz	
Under Voltage Lockout	V_{on} V_{off}	V_{in} increasing V_{in} decreasing		—	34	36	V
				30	32	—	
Enable Control (pins 3 & 4) High-Level Input Voltage Low-Level Input Voltage Low-Level Input Current	V_{IH} V_{IL} I_{IL}	Referenced to $-V_{in}$ (pin 2)		3.5	—	Open (3)	V
				-0.2	—	0.8 (3)	
				—	0.5	—	mA
Standby Input Current	$I_{in, standby}$	pins 3 & 4 open circuit	—	2.5	4 (1)	mA	
Internal Input Capacitance	C_{int}		—	2	—	μF	
External Output Capacitance	C_{out}	Per each output	0	—	5,000	μF	
Primary/Secondary Isolation	V_{iso} C_{iso} R_{iso}			1500	—	—	V
				—	2,200	—	pF
				10	—	—	M Ω
Temperature Sense	V_{temp}	Output voltage at temperatures:-	-40°C	—	0.1 (4)	—	V
			100°C	—	1.5 (4)	—	

Notes: (1) Limits are specified by design.

(2) This is a fixed parameter. Adjusting V_{o1} or V_{o2} higher will increase the module's sensitivity to over-voltage detection. For more information, see the application note on output voltage adjustment.

(3) The Enable inputs (pins 3 & 4) have internal pull-ups. Leaving pin 4 open-circuit and connecting pin 3 to $-V_{in}$ (pin 2) allows the the converter to operate when input power is applied. The maximum open-circuit voltage for the Enable inputs is 5.4V.

(4) Voltage output at "TEMP" pin is defined by the equation:- $V_{TEMP} = 0.5 + 0.01 \cdot T$, where T is in $^\circ\text{C}$. See pin descriptions for more information.

PT4856 Performance Characteristics (See Note A)
($I_{o1} = 10A, I_{o2} = 7.5A, I_{o3} = 7.5A$ represents 100% Load)

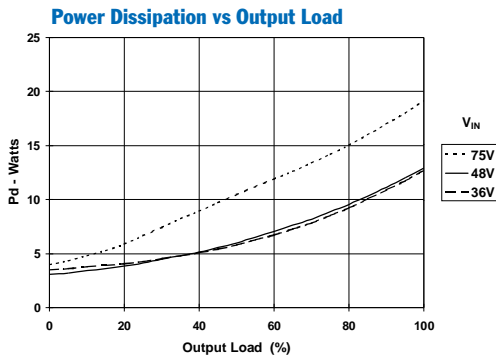
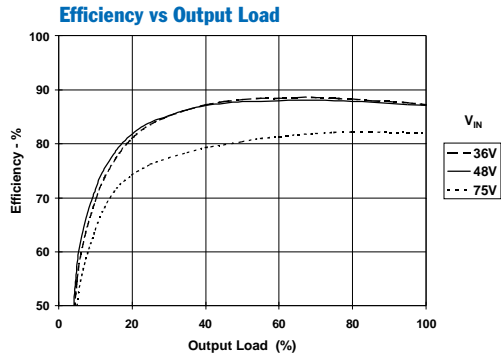

PT4856 Safe operating Area Curves (See Note B)
($I_{o1} + I_{o2} + I_{o3} = 24A$, represents 100% load)

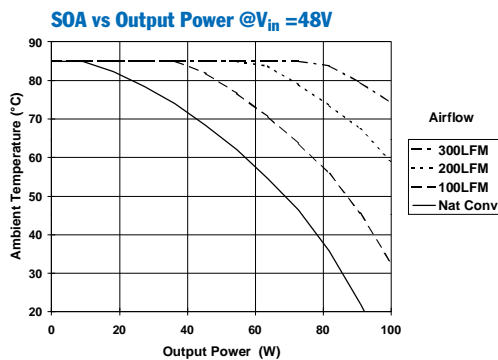

Note A: All Characteristic data in the above graphs has been developed from actual products tested at 25°C. This data is considered typical data for the ISR.

Note B: SOA curves represent operating conditions at which the internal components are at or below the manufacturer's maximum rated operating temperatures.

Operating Features of the PT4850 Triple-Output DC/DC Converters

Over-Current Protection

The PT4850 series of DC/DC converters provide three independently regulated logic output voltages, V_{O1} , V_{O2} , and V_{O3} . Each output is current limited to protect against load faults. The module will not be damaged by a continuous load fault applied to any output. Current will continue to flow into the fault but is reduced as the voltage across the fault decreases towards zero.

Applying a load fault above the current limit threshold to any output causes the affected output to significantly drop. Also load faults applied to V_{O1} will affect V_{O2} and V_{O3} , once V_{O1} drops to within 0.2V of either of these voltages. However, load faults applied to V_{O2} or V_{O3} will not affect the other outputs.

Over-Temperature Protection

The PT4850 DC/DC converter series have an internal temperature sensor, which monitors the temperature of the module's metal case. If the case temperature exceeds the specified limit the converter will shut down. The converter will automatically restart when the sensed temperature returns to within the normal operating range. The analog voltage generated by the sensor is also made available at the 'TEMP' output (pin 5), and can be monitored by the host system for diagnostic purposes. Consult the 'Pin Descriptions' section of the data sheet for more information on this feature.

Under-Voltage Lock-Out

The Under-Voltage Lock-Out (UVLO) circuit prevents operation of the converter whenever the input voltage to the module is insufficient to maintain output regulation. The UVLO has approximately 2V of hysteresis. This is to prevent oscillation with a slowly changing input voltage. Below the UVLO threshold the module is off and the enable control inputs, EN1 and EN2 are inoperative.

Primary-Secondary Isolation

The PT4850 series of DC/DC converters incorporate electrical isolation between the input terminals (primary) and the output terminals (secondary). All converters are production tested to a withstand voltage of 1500VDC. The isolation complies with UL60950 and EN60950, and the requirements for operational isolation. This allows the converter to be configured for either a positive or negative input voltage source.

The regulation control circuitry for these modules is located on the secondary (output) side of the isolation barrier. Control signals are passed between the primary and secondary sides of the converter via a proprietary magnetic coupling scheme. This eliminates the use of opto-couplers. The data sheet 'Pin Descriptions' and 'Pin-Out Information' provides guidance as to which reference (primary or secondary) that must be used for each of the external control signals.

Fuse Recommendations

If desired an input fuse may be added to protect against the application of a reverse input voltage.

Using the On/Off Enable Controls on the PT4850 Series of Triple Output DC/DC Converters

The PT4850 (48V input) series of 25-A, triple-output DC/DC converters incorporate two output enable controls. EN1 (pin 3) is the *Negative Enable* input, and EN2 (pin 4) is the *Positive Enable* input. Both inputs are electrically referenced to $-V_{in}$ (pin 2) on the primary or input side of the converter. A pull-up resistor is not required, but may be added if desired. Voltages of up to 70V can be safely applied to the either of the *Enable* pins.

Automatic (UVLO) Power-Up

Connecting EN1 (pin 3) to $-V_{in}$ (pin 2) and leaving EN2 (pin 4) open-circuit configures the converter for automatic power up. (See data sheet “Typical Application”). The converter control circuitry incorporates an “Under Voltage Lockout” (UVLO) function, which disables the converter until the minimum specified input voltage is present at $\pm V_{in}$. (See data sheet Specifications). The UVLO circuitry ensures a clean transition during power-up and power-down, allowing the converter to tolerate a slow-rising input voltage. For most applications EN1 and EN2, can be configured for automatic power-up.

Positive Output Enable (Negative Inhibit)

To configure the converter for a positive enable function, connect EN1 (pin 3) to $-V_{in}$ (pin 2), and apply the system On/Off control signal to EN2 (pin 4). In this configuration, a low-level input voltage ($-V_{in}$ potential) applied to pin 4 disables the converter outputs. Figure 1 is an example of this configuration.

Figure 1; Positive Enable Configuration

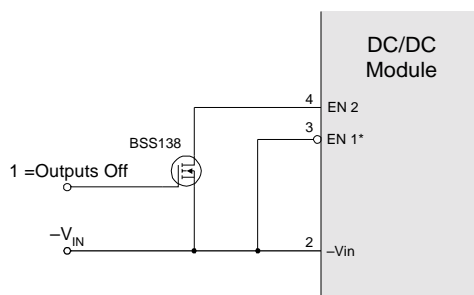

Negative Output Enable (Positive Inhibit)

To configure the converter for a negative enable function, EN2 (pin 4) is left open circuit, and the system On/Off control signal is applied to EN1 (pin 3). A low-level input voltage ($-V_{in}$ potential) must then be applied to

pin 3 in order to enable the outputs of the converter. An example of this configuration is detailed in Figure 2. *Note: The converter will only produce and output voltage if a valid input voltage is applied to $\pm V_{in}$.*

Figure 2; Negative Enable Configuration

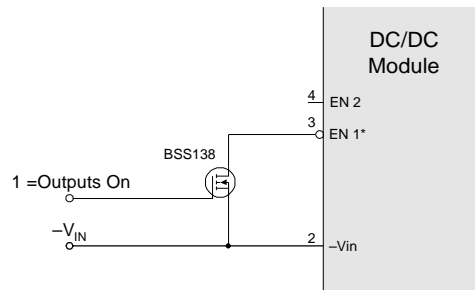

On/Off Output Voltage Sequencing

The power-up characteristic of the PT4850 series of DC/DC converters meets the requirements of micro-processor and DSP chipsets. All three outputs from the converter are internally sequenced to power up in unison. Figure 3 shows the waveforms from a PT4851 after power is applied to the input of the converter. During power-up, all three output voltages rise together until each reaches their respective output voltage. The waveforms of Figure 3 were measured with loads of approximately 50% on each output, with an input source of 48VDC. The converter typically produces a fully regulated output within 150ms.

Figure 3; Vo1, Vo2, Vo3 Power-Up Sequence

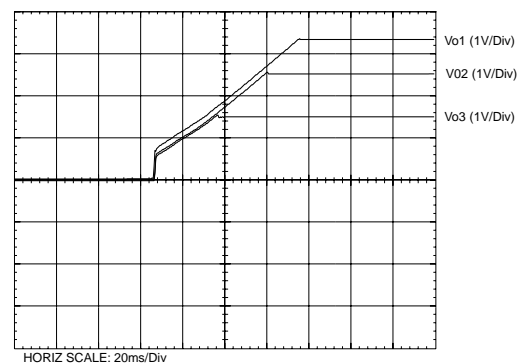

During turn-off, all outputs drop rapidly due to the discharging effect of actively switched rectifiers. The voltage at V_{o2} remains higher than V_{o3} during this period. The discharge time is typically 100 μ s, but will vary with the amount of external load capacitance.

Adjusting the Output Voltages of the PT4850 Triple-Output DC/DC Converters

The output voltages of the PT4850 series of triple-output DC/DC converters, V_{O1} , V_{O2} and V_{O3} , are independently adjustable. The adjustment method uses a single external resistor, R_1 which may be used to adjust a selected output by up to $\pm 10\%$ from the factory preset value. The value of the resistor determines the magnitude of adjustment, and the placement of the resistor determines the direction of adjustment (up or down). The resistor values can be calculated using the appropriate formula (see below), using the constants provided in Table 3-2. Alternatively the resistor value may be selected directly from Table 3-3 and Table 3-4, for V_{O1} and V_{O2}/V_{O3} respectively. The placement of each resistor is as follows.

Adjust Up: To increase a specific output, add a resistor R_1 between the appropriate $V_x Adj$ ($V_1 Adj$, $V_2 Adj$, or $V_3 Adj$) and the output common (COM). See Figure 3-1(a) and Table 3-1 for the resistor placement and pin connections.

Figure 3-1a

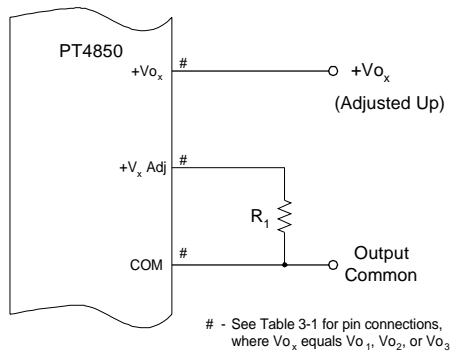

Adjust Down: Add a resistor (R_2), between the appropriate $V_x Adj$ ($V_1 Adj$, $V_2 Adj$, or $V_3 Adj$) and the output being adjusted, $+V_{O_x}$. See Figure 3-1(b) and Table 3-1 for the resistor placement and pin connections.

Figure 3-1b

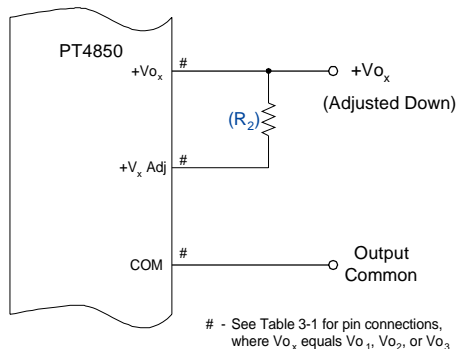

Table 3-1; Adjust Resistor Pin Connections

	To Adjust Up Connect R_1		To Adjust Down Connect (R_2)	
	from $V_{O_x} Adj$	to COM	from $V_{O_x} Adj$	to V_{O_x}
V_{O1}	8	12	8	9
V_{O2}	17	18	17	16
V_{O3}	21	18	21	22

Calculation of Adjust Values

The adjust resistor value may also be calculated using an equation. In each case, the equation for R_1 [Adjust Up] is different to that for (R_2) [Adjust Down]. For the PT4850 series, the following points should be noted.

- V_{O1} uses different equations to V_{O2} and V_{O3} . The equations are defined for the desired output voltage.
- The equations for V_{O2} and V_{O3} are based on the percentage of desired adjustment. Both V_{O2} and V_{O3} use the same constants, which are common for all output voltages.

V_{O1} Adjust:

$$R_1 \text{ [Adjust Up]}^3 = \frac{2.5 R_o}{V_a - V_o} - R_s \quad \text{k}\Omega$$

$$(\mathbf{R_2}) \text{ [Adjust Down]}^3 = \frac{R_o (V_a - 2.5)}{V_o - V_a} - R_s \quad \text{k}\Omega$$

Where: V_o = Original output voltage
 V_a = Adjusted output voltage
 R_o = The resistance value in Table 3-2
 R_s = The series resistance from Table 3-2

V_{O2} / V_{O3} Adjust:

$$R_1 \text{ [Adjust Up]}^3 = \frac{50 \cdot R_o}{n\%} - R_s \quad \text{k}\Omega$$

$$(\mathbf{R_2}) \text{ [Adjust Down]}^3 = R_o \cdot \frac{(50 - n\%)}{n\%} - R_s \quad \text{k}\Omega$$

Where: R_o = The resistance value in Table 3-2
 R_s = The series resistance from Table 3-2
 $n\%$ = The desired adjustment from the nominal (in percent)

Notes:

1. Use only a single 1% (or better) tolerance resistor in either the R₁ or (R₂) location to adjust a specific output. Place the resistor as close to the ISR as possible.
2. Never connect capacitors to any of the 'Vo_x Adj' pins. Any capacitance added to these control pins will affect the stability of the respective regulated output.
3. Adjustments made to any output must also comply with the following limitations.

$$V_{O1} \geq (V_{O2} + 0.5V), \text{ and}$$

$$V_{O1} \geq (V_{O3} + 0.5V)$$

Table 3-2

ADJUSTMENT RANGE AND FORMULA PARAMETERS			
	Vo ₁ Bus		Vo ₂ / Vo ₃ Bus
V_O(nom)	5.0V	3.3V	All
V_a(min)	4.5V	2.97V	V _{nom} – 10%
V_a(max)	5.5V	3.63V	V _{nom} + 10%
R_O (kΩ)	4.99	4.42	2.1
R_S (kΩ)	4.99	4.99	4.99

Table 3-3

ADJUSTMENT RESISTOR VALUES FOR Vo ₁ Bus		
Adj. Resistors	R ₁ /(R ₂)	
V_O(nom)	3.3V	5.0V
V_a(req'd)		
3.0	(2.4)kΩ	
3.05	(4.7)kΩ	
3.1	(8.3)kΩ	
3.15	(14.2)kΩ	
3.2	(26.0)kΩ	
3.25	(61.3)kΩ	
3.3		
3.35	216.0kΩ	
3.4	106.0kΩ	
3.45	68.7kΩ	
3.5	50.3kΩ	
3.55	39.2kΩ	
3.6	31.8kΩ	
•		
4.5	(15.0)kΩ	
4.6	(21.2)kΩ	
4.7	(31.6)kΩ	
4.8	(52.4)kΩ	
4.9	(115.0)kΩ	
5.0		
5.1	120.0kΩ	
5.2	57.4kΩ	
5.3	36.6kΩ	
5.4	26.2kΩ	
5.5	20.0kΩ	

R₁ = Black, R₂ = (Blue)

Table 3-4

ADJUSTMENT RESISTOR VALUES FOR Vo ₂ / Vo ₃ Buses						
V _O (nom)	3.3V	2.5V	1.8V	1.5V	1.2V	
% Adjust	Adjusted Output Voltage					R ₁ /(R ₂)
-10	2.97	2.25	1.62	1.35	1.08	(3.4)kΩ
-9	3.003	2.275	1.638	1.365	1.092	(4.6)kΩ
-8	3.036	2.3	1.656	1.38	1.104	(6.0)kΩ
-7	3.069	2.325	1.674	1.395	1.116	(7.9)kΩ
-6	3.102	2.35	1.692	1.41	1.128	(10.4)kΩ
-5	3.135	2.375	1.71	1.425	1.14	(13.9)kΩ
-4	3.168	2.4	1.728	1.44	1.152	(19.2)kΩ
-3	3.201	2.425	1.746	1.455	1.64	(27.9)kΩ
-2	3.234	2.45	1.764	1.47	1.176	(45.4)kΩ
-1	3.267	2.475	1.782	1.485	1.188	(97.9)kΩ
0	3.3	2.5	1.8	1.5	1.2	
+1	3.333	2.525	1.818	1.515	1.212	100.0kΩ
+2	3.366	2.55	1.836	1.53	1.224	47.5kΩ
+3	3.399	2.575	1.854	1.545	1.236	30.0kΩ
+4	3.432	2.6	1.872	1.56	1.248	21.3kΩ
+5	3.465	2.625	1.89	1.575	1.26	16.0kΩ
+6	3.498	2.65	1.908	1.58	1.272	12.5kΩ
+7	3.531	2.675	1.926	1.605	1.284	10.0kΩ
+8	3.564	2.7	1.944	1.62	1.296	8.1kΩ
+9	3.597	2.725	1.962	1.635	1.308	6.7kΩ
+10	3.630	2.75	1.98	1.65	1.32	5.5kΩ

R₁ = Black, R₂ = (Blue)

PACKAGING INFORMATION

Orderable Device	Status ⁽¹⁾	Package Type	Package Drawing	Pins	Package Qty	Eco Plan ⁽²⁾	Lead/ Ball Finish	MSL Peak Temp ⁽³⁾	Samples (Requires Login)
PT4851A	NRND	SIP MODULE	EKA	26	6	TBD	Call TI	Level-1-215C-UNLIM	Samples Not Available
PT4851C	NRND	SIP MODULE	EKC	26	6	TBD	Call TI	Level-3-215C-168HRS	Samples Not Available
PT4851N	NRND	SIP MODULE	EKD	26	6	TBD	Call TI	Level-1-215C-UNLIM	Samples Not Available
PT4852A	NRND	SIP MODULE	EKA	26	6	TBD	Call TI	Level-1-215C-UNLIM	Samples Not Available
PT4852C	NRND	SIP MODULE	EKC	26	6	TBD	Call TI	Level-3-215C-168HRS	Samples Not Available
PT4852N	NRND	SIP MODULE	EKD	26	6	TBD	Call TI	Level-1-215C-UNLIM	Samples Not Available
PT4853A	NRND	SIP MODULE	EKA	26	6	TBD	Call TI	Level-1-215C-UNLIM	Samples Not Available
PT4853C	NRND	SIP MODULE	EKC	26	6	TBD	Call TI	Level-3-215C-168HRS	Samples Not Available
PT4853N	NRND	SIP MODULE	EKD	26	6	TBD	Call TI	Level-1-215C-UNLIM	Samples Not Available
PT4854A	NRND	SIP MODULE	EKA	26	6	TBD	Call TI	Level-1-215C-UNLIM	Samples Not Available
PT4854C	NRND	SIP MODULE	EKC	26	6	TBD	Call TI	Level-3-215C-168HRS	Samples Not Available
PT4854N	NRND	SIP MODULE	EKD	26	6	TBD	Call TI	Level-1-215C-UNLIM	Samples Not Available
PT4855A	NRND	SIP MODULE	EKA	26	6	TBD	Call TI	Level-1-215C-UNLIM	Samples Not Available
PT4855C	NRND	SIP MODULE	EKC	26	6	TBD	Call TI	Level-3-215C-168HRS	Samples Not Available
PT4855N	NRND	SIP MODULE	EKD	26	6	TBD	Call TI	Level-1-215C-UNLIM	Samples Not Available
PT4856A	NRND	SIP MODULE	EKA	26	6	TBD	Call TI	Level-1-215C-UNLIM	Samples Not Available
PT4856C	NRND	SIP MODULE	EKC	26	6	TBD	Call TI	Level-3-215C-168HRS	Samples Not Available
PT4856N	NRND	SIP MODULE	EKD	26	6	TBD	Call TI	Level-1-215C-UNLIM	Samples Not Available

⁽¹⁾ The marketing status values are defined as follows:

ACTIVE: Product device recommended for new designs.

LIFEBUY: TI has announced that the device will be discontinued, and a lifetime-buy period is in effect.

NRND: Not recommended for new designs. Device is in production to support existing customers, but TI does not recommend using this part in a new design.

PREVIEW: Device has been announced but is not in production. Samples may or may not be available.

OBSOLETE: TI has discontinued the production of the device.

⁽²⁾ Eco Plan - The planned eco-friendly classification: Pb-Free (RoHS), Pb-Free (RoHS Exempt), or Green (RoHS & no Sb/Br) - please check <http://www.ti.com/productcontent> for the latest availability information and additional product content details.

TBD: The Pb-Free/Green conversion plan has not been defined.

Pb-Free (RoHS): TI's terms "Lead-Free" or "Pb-Free" mean semiconductor products that are compatible with the current RoHS requirements for all 6 substances, including the requirement that lead not exceed 0.1% by weight in homogeneous materials. Where designed to be soldered at high temperatures, TI Pb-Free products are suitable for use in specified lead-free processes.

Pb-Free (RoHS Exempt): This component has a RoHS exemption for either 1) lead-based flip-chip solder bumps used between the die and package, or 2) lead-based die adhesive used between the die and leadframe. The component is otherwise considered Pb-Free (RoHS compatible) as defined above.

Green (RoHS & no Sb/Br): TI defines "Green" to mean Pb-Free (RoHS compatible), and free of Bromine (Br) and Antimony (Sb) based flame retardants (Br or Sb do not exceed 0.1% by weight in homogeneous material)

⁽³⁾ MSL, Peak Temp. -- The Moisture Sensitivity Level rating according to the JEDEC industry standard classifications, and peak solder temperature.

Important Information and Disclaimer: The information provided on this page represents TI's knowledge and belief as of the date that it is provided. TI bases its knowledge and belief on information provided by third parties, and makes no representation or warranty as to the accuracy of such information. Efforts are underway to better integrate information from third parties. TI has taken and continues to take reasonable steps to provide representative and accurate information but may not have conducted destructive testing or chemical analysis on incoming materials and chemicals. TI and TI suppliers consider certain information to be proprietary, and thus CAS numbers and other limited information may not be available for release.

In no event shall TI's liability arising out of such information exceed the total purchase price of the TI part(s) at issue in this document sold by TI to Customer on an annual basis.

IMPORTANT NOTICE

Texas Instruments Incorporated and its subsidiaries (TI) reserve the right to make corrections, modifications, enhancements, improvements, and other changes to its products and services at any time and to discontinue any product or service without notice. Customers should obtain the latest relevant information before placing orders and should verify that such information is current and complete. All products are sold subject to TI's terms and conditions of sale supplied at the time of order acknowledgment.

TI warrants performance of its hardware products to the specifications applicable at the time of sale in accordance with TI's standard warranty. Testing and other quality control techniques are used to the extent TI deems necessary to support this warranty. Except where mandated by government requirements, testing of all parameters of each product is not necessarily performed.

TI assumes no liability for applications assistance or customer product design. Customers are responsible for their products and applications using TI components. To minimize the risks associated with customer products and applications, customers should provide adequate design and operating safeguards.

TI does not warrant or represent that any license, either express or implied, is granted under any TI patent right, copyright, mask work right, or other TI intellectual property right relating to any combination, machine, or process in which TI products or services are used. Information published by TI regarding third-party products or services does not constitute a license from TI to use such products or services or a warranty or endorsement thereof. Use of such information may require a license from a third party under the patents or other intellectual property of the third party, or a license from TI under the patents or other intellectual property of TI.

Reproduction of TI information in TI data books or data sheets is permissible only if reproduction is without alteration and is accompanied by all associated warranties, conditions, limitations, and notices. Reproduction of this information with alteration is an unfair and deceptive business practice. TI is not responsible or liable for such altered documentation. Information of third parties may be subject to additional restrictions.

Resale of TI products or services with statements different from or beyond the parameters stated by TI for that product or service voids all express and any implied warranties for the associated TI product or service and is an unfair and deceptive business practice. TI is not responsible or liable for any such statements.

TI products are not authorized for use in safety-critical applications (such as life support) where a failure of the TI product would reasonably be expected to cause severe personal injury or death, unless officers of the parties have executed an agreement specifically governing such use. Buyers represent that they have all necessary expertise in the safety and regulatory ramifications of their applications, and acknowledge and agree that they are solely responsible for all legal, regulatory and safety-related requirements concerning their products and any use of TI products in such safety-critical applications, notwithstanding any applications-related information or support that may be provided by TI. Further, Buyers must fully indemnify TI and its representatives against any damages arising out of the use of TI products in such safety-critical applications.

TI products are neither designed nor intended for use in military/aerospace applications or environments unless the TI products are specifically designated by TI as military-grade or "enhanced plastic." Only products designated by TI as military-grade meet military specifications. Buyers acknowledge and agree that any such use of TI products which TI has not designated as military-grade is solely at the Buyer's risk, and that they are solely responsible for compliance with all legal and regulatory requirements in connection with such use.

TI products are neither designed nor intended for use in automotive applications or environments unless the specific TI products are designated by TI as compliant with ISO/TS 16949 requirements. Buyers acknowledge and agree that, if they use any non-designated products in automotive applications, TI will not be responsible for any failure to meet such requirements.

Following are URLs where you can obtain information on other Texas Instruments products and application solutions:

Products		Applications	
Amplifiers	amplifier.ti.com	Audio	www.ti.com/audio
Data Converters	dataconverter.ti.com	Automotive	www.ti.com/automotive
DLP® Products	www.dlp.com	Communications and Telecom	www.ti.com/communications
DSP	dsp.ti.com	Computers and Peripherals	www.ti.com/computers
Clocks and Timers	www.ti.com/clocks	Consumer Electronics	www.ti.com/consumer-apps
Interface	interface.ti.com	Energy	www.ti.com/energy
Logic	logic.ti.com	Industrial	www.ti.com/industrial
Power Mgmt	power.ti.com	Medical	www.ti.com/medical
Microcontrollers	microcontroller.ti.com	Security	www.ti.com/security
RFID	www.ti-rfid.com	Space, Avionics & Defense	www.ti.com/space-avionics-defense
RF/IF and ZigBee® Solutions	www.ti.com/lprf	Video and Imaging	www.ti.com/video
		Wireless	www.ti.com/wireless-apps