

300 mA non-isolated ultra high-voltage buck evaluation board using ICE5BR3995BZ

EVAL_5BR3995BZ_BUCK1

About this document



Scope and purpose

This document is an engineering report that describes a non-isolated 18 V, 300 mA ultra high-voltage buck converter using the latest fifth-generation Infineon fixed-frequency (FF) CoolSET™ **ICE5BR3995BZ**. The document contains power supply specifications, schematics, bill of materials (BOM), PCB layout and performance data. This evaluation board is designed for users who wish to evaluate the performance of ICE5BR3995BZ and its ease of use.

Intended audience

This document is intended for SMPS design/application engineers, students, etc., who wish to design low-cost and non-isolated buck converters, such as auxiliary power supplies for white goods, smart metering, etc.

Table of contents

About this document	1
Table of contents	1
1 Abstract	3
2 Evaluation board	4
3 Specifications of evaluation board	5
4 Circuit diagram	6
5 Circuit description	7
5.1 Line input.....	7
5.2 Start-up.....	7
5.3 Integrated MOSFET and PWM control	7
5.4 Output stage.....	7
5.5 Feedback control.....	7
5.6 Primary-side peak-current control.....	7
5.7 Frequency reduction	7
5.8 Active burst mode	8
5.9 Protection feature	8
6 PCB layout	9
6.1 Top side	9
6.2 Bottom side	9
7 Bill of materials	10
8 Test results	12
8.1 Efficiency.....	12
8.2 Standby power	13
8.3 Line regulation at full load	14
8.4 Load regulation	14

Table of contents

8.5	Surge immunity (EN 61000-4-5)	15
8.6	Conducted emissions (EN 55022 class B)	15
8.7	Thermal measurement	16
9	Waveforms and scope plots.....	18
9.1	Start-up with maximum load	18
9.2	Soft-start.....	18
9.3	Drain voltage and current at maximum load	19
9.4	Output ripple voltage at maximum load	19
9.5	ABM operation	20
9.6	Overload protection (odd-skip auto-restart)	20
9.7	Output short test.....	21
10	Design example A.....	22
10.1	Specification of design example A.....	22
10.2	Full-load efficiency	22
11	Design example B.....	23
11.1	Circuit diagram of design example B.....	23
11.2	Specification of design example B.....	23
11.3	Bill of materials of design example B	23
11.4	Test results of design example B	25
11.4.1	Efficiency and standby power	25
11.4.2	Output voltage regulation – design example B.....	27
11.5	Thermal measurement – design example B.....	28
12	References	29
	Revision history.....	30

Abstract

1 Abstract

This engineering report describes a 5.4 W 18 V evaluation board designed in a buck converter topology using the fifth-generation FF CoolSET™ ICE5BR3995BZ. The target applications of ICE5BR3995BZ are either auxiliary power supplies for white goods, PCs, servers or TVs, or enclosed adapters for Blu-ray players, set-top boxes, games consoles, smart metering, etc. The 950 V CoolMOS™ integrated into this IC greatly simplifies the design and layout of the PCB. The new improved digital frequency reduction and frequency jitter feature offers lower EMI and higher efficiency. The enhanced active burst mode (ABM) power enables flexibility in standby power operation range selection. In addition, numerous adjustable protection functions have been implemented in ICE5BR3995BZ to protect the system and customize the IC for the chosen application.

2 Evaluation board

This document contains the list of features, the power supply specifications, schematics, BOM and performance data. Typical operating characteristics such as performance curve and scope waveforms are shown at the end of the report.

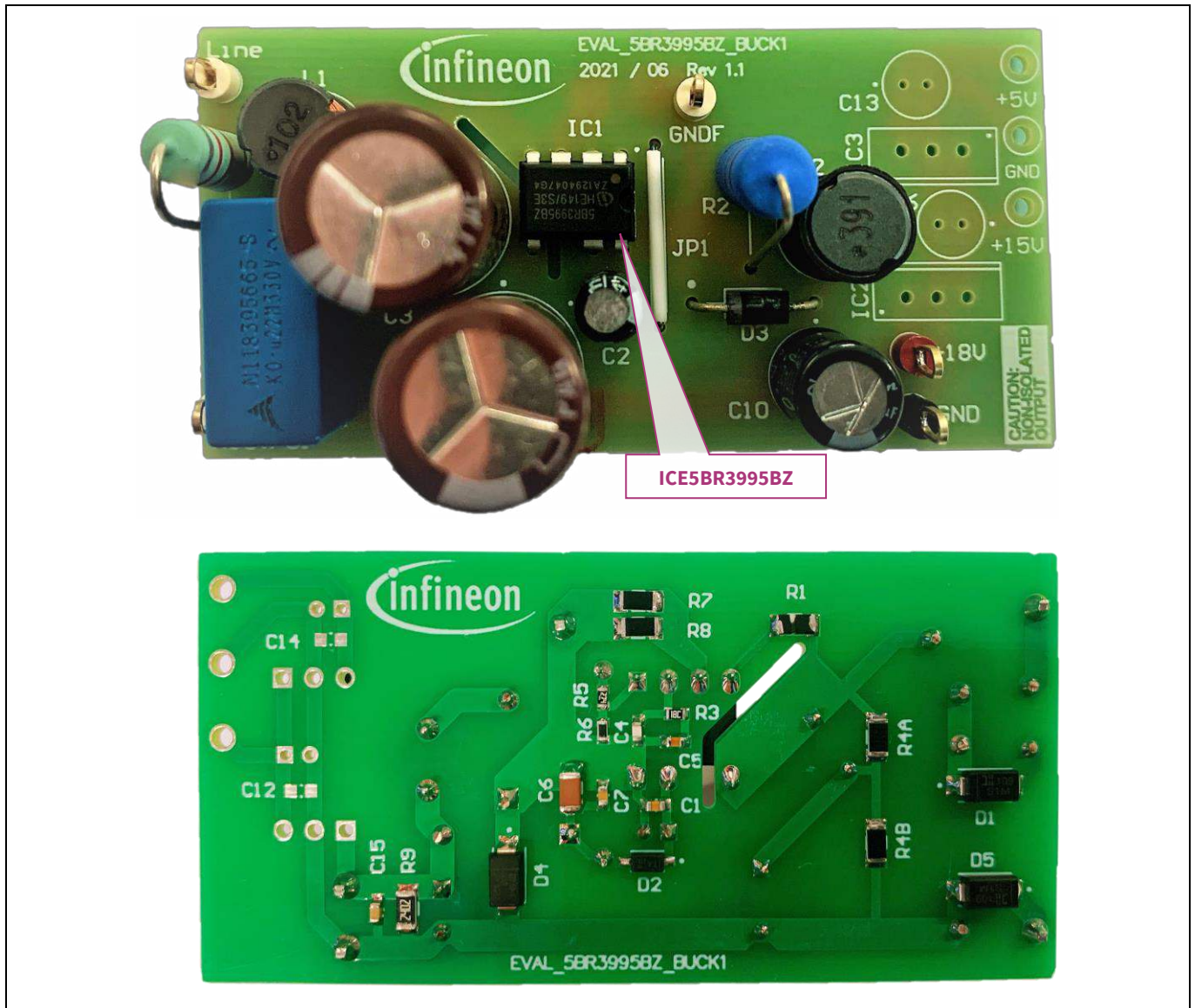

Figure 1 EVAL_5BR3995BZ_BUCK1

3 Specifications of evaluation board

Table 1 Specifications of EVAL_5BR3995BZ_BUCK1

Description	Symbol	Min.	Typ.	Max.	Units	Comments
Input						
Voltage	V_{IN}	85		460	V AC	2-wire (no P.E.)
Frequency	f_{LINE}	47	50/60	63	Hz	
Output						
Voltage	V_{OUT}		18		V	
Current	I_{OUT}		0.3		A	
Output power	P_{OUT}		5.4		W	
Output voltage accuracy		Less than $\pm 5\%$				
Overcurrent protection		Less than 150% of rated current			A	
Ripple and noise voltage	V_{pk-pk}	Less than 1% (20 MHz bandwidth)			mV	With 10 μ F E-cap and 0.1 μ F MLCC
Environmental						
Conducted EMI			6		dB	Margin, CISPR 22 class B EN 61000-4-5
Surge immunity Differential mode (DM)			± 1		kV	
Ambient temperature	T_{amb}	-20	-	50	$^{\circ}$ C	Free convection, sea level
PCB form factor		35 \times 70			mm ²	L \times W

Note: The table above shows the minimum acceptable performance of the design; actual measurement results are listed in the test results section. This evaluation board is designed to demonstrate the maximum output current only.

5 Circuit description

5.1 Line input

The AC-line input stage comprises the input fuse F1, rectifier diode D1 and D5, capacitors C8, C3 and C9, and inductor L1. Fuse F1 is a flameproof, fusible resistor that can act as an input fuse for overcurrent and also limit inrush current for rectifiers D1 and D5. The X-capacitors C8 and inductor L1 act as EMI suppressors. A rectified DC voltage (120 ~ 650 V DC) is held by the bulk capacitor C3 and C9 in series.

5.2 Start-up

ICE5BR3995BZ uses a cascode structure to fast-charge the V_{CC} capacitor. Pull-up resistors R1 connected to the GATE pin (pin 4) are used to initiate the start-up phase. When V_{VCC} reaches the turn-on voltage threshold 16 V, the IC begins with a soft-start. The soft-start implemented in ICE5BR3995BZ is a digital time-based function. The preset soft-start time is 12 ms with four steps. If not limited by other functions, the peak voltage on the CS pin will increase in increments from 0.3 V to 1 V. After IC turn-on, the V_{CC} voltage is supplied by output voltage. V_{CC} short-to-GND protection is implemented during the start-up time.

5.3 Integrated MOSFET and PWM control

ICE5BR3995BZ is comprised of a power MOSFET and the controller, which simplifies the circuit layout and reduces the cost of PCB manufacture. The controller together with the MOSFET is placed at the high side of the converter with a floating ground at the cathode of freewheeling diode D4. Thus output voltage is sensed only during freewheeling diode conduction time.

5.4 Output stage

The maximum output voltage ripple is determined by the output capacitance and the equivalent series resistance (ESR) of the output capacitor. Selection of a low-ESR capacitor helps reduce ripple. The dummy load resistor R9 helps output voltage regulation at light-load condition.

5.5 Feedback control

ICE5BR3995BZ integrates a transconductance amplifier for feedback control. The output is sensed by the voltage divider (R5 and R6) and compared with an internal reference voltage at the VERR pin. An external compensation network (C4, C5 and R3) is recommended on the FB pin to control output voltage.

5.6 Primary-side peak-current control

The MOSFET drain-source current is sensed via external resistors R7 and R8. ICE5BR3995BZ is a current mode controller that has a cycle-by-cycle primary current and FB voltage control, which ensures the converter's maximum power is controlled in every switching cycle. To avoid mistripping caused by MOSFET switch-on transient voltage spikes, a leading-edge blanking (LEB) time (t_{CS_LEB}) is integrated in the current sensing (CS) path.

5.7 Frequency reduction

Frequency reduction is implemented in ICE5BR3995BZ to achieve better efficiency during light load. At light load, the reduced switching frequency F_{SW} improves efficiency by reducing the switching losses. When load decreases, V_{FB} decreases accordingly while F_{SW} decreases. Typically, F_{SW} at high load is 65 kHz and starts to decrease at $V_{FB} = 1.7$ V. There is no further frequency reduction once it reaches the f_{OSC_MIN} even if the load is further reduced.

5.8 Active burst mode

ABM entry and exit power (two levels) can be selected in ICE5BR3995BZ. Details are illustrated in the product datasheet. ABM power level 1 is used in this evaluation board (R4 = open).

5.9 Protection feature

ICE5BR3995BZ provides comprehensive protection to ensure safe operation of the system. This includes V_{CC} overvoltage (OV) and undervoltage (UV), overload, output OV, overtemperature (controller junction) and V_{CC} short-to-GND. When those faults are found, the system will enter protection mode. Once the fault is removed, the system resumes normal operation.

PCB layout

6 PCB layout

6.1 Top side

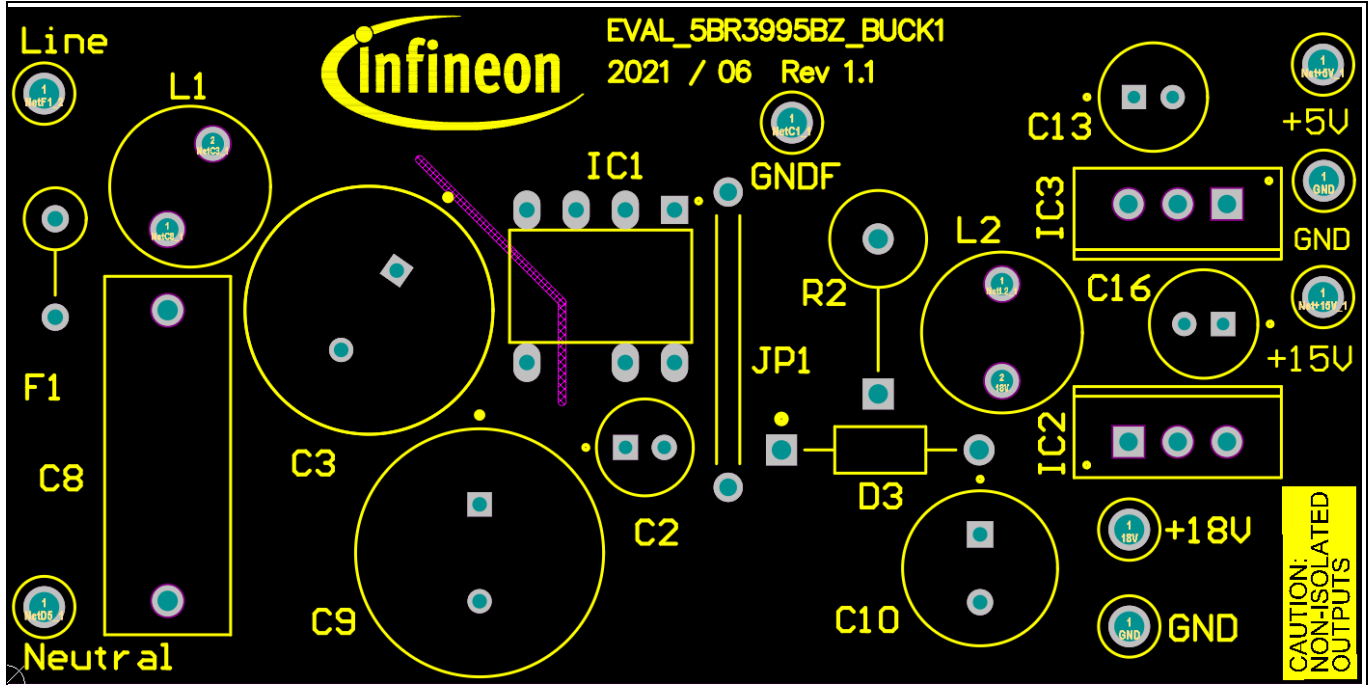

Figure 3 Top-side component legend

6.2 Bottom side

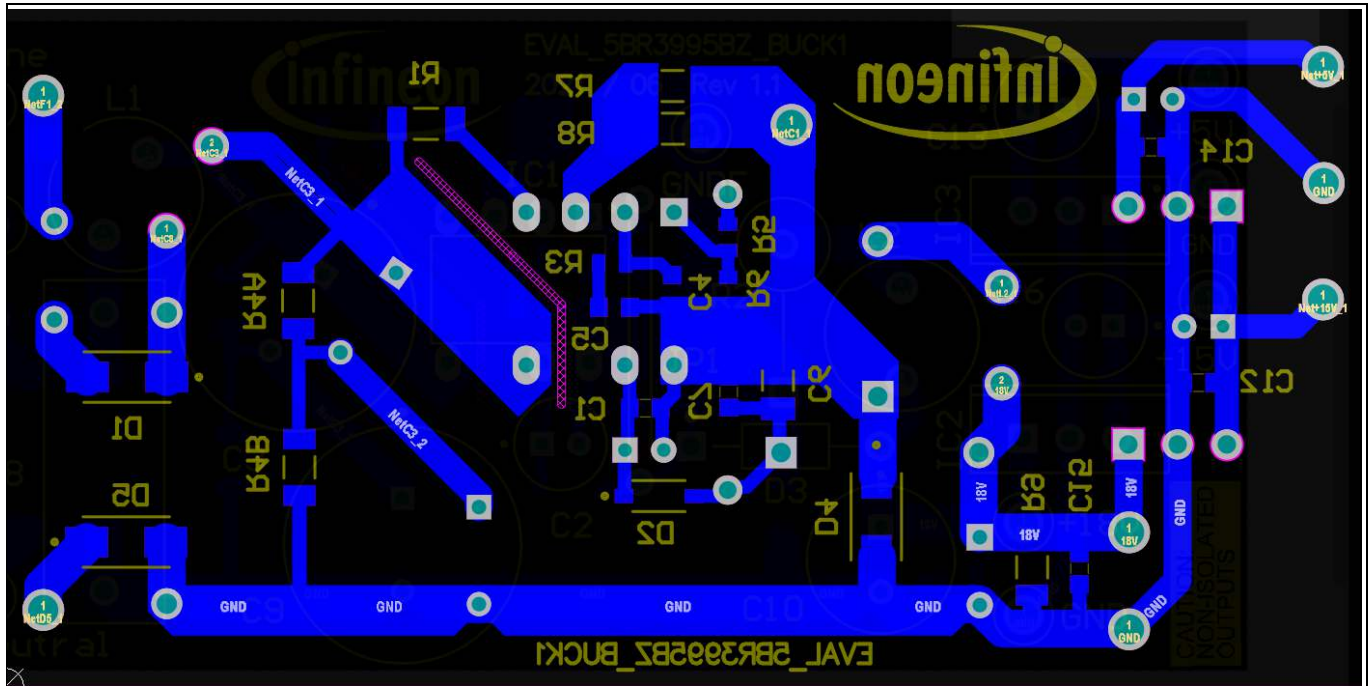

Figure 4 Bottom-side copper and component legend

Bill of materials

7 Bill of materials

Table 2 BOM

No.	Designator	Description	Manufacturer	Part number	Quantity
1	C2	Aluminum capacitor 47 μ F 20% 35 V radial	Nichicon	UVZ1V470MDD1 TA	1
2	C1, C7	Ceramic capacitor 100 nF 50 V X7R 0603			2
3	C3, C9	Aluminum capacitor 47 μ F 20% 400 V radial	United Chemi-Con	EPAG401ELL470 MK30S	2
4	C15	Ceramic capacitor 0.33 μ F 25 V X7R 0603			1
5	C4	Ceramic capacitor 220 pF 50 V X7R 0603			1
6	C5	Ceramic capacitor 0.068 μ F 50 V X7R 0603			1
7	C6	Ceramic capacitor 2.2 μ F 50 V X7R 1206	Murata	GCM31MR71E22 5KA57	1
8	C8	Film capacitor 0.22 μ F 20% 760 V DC radial	Epcos	B32912B3224M	1
9	C10	Aluminum capacitor 220 μ F 20% 35V radial	Rubycon	35ZLQ220MEFC 8X11.5	1
10	D2	General-purpose diode 100 V 150 mA SOD-123	Diodes Incorporated	BAV16W-7-F	1
11	D3	General-purpose diode 1 kV 1 A DO204AL	Vishay	UF4007-E3/73	1
12	D4	General-purpose diode 800 V 1 A SMA	Bourns	CD214A-FS1K	1
13	D1, D5	General-purpose diode 1 kV 1 A SMA	STMicroelectronics	S1M-13-F	2
14	F1	Resistor 8.2 Ω 2 W 5% axial, flameproof, fusible, safety wirewound	Yageo	FKN200JR-73-8R2	1
15	IC1	Fifth-generation FF CoolSET™ DIP7	Infineon Technologies	ICE5BR3995BZ	1
16	JP1	Through-hole jumper, 15.24 mm pitch, 2 pins	3M	923345-06-C	1
17	R2	Resistor 5 W XSM M/OX 5% 6R2	TE Connectivity	ROX5SSJ6R2	1
18	R5	SMD resistor 270 k Ω 1% 1/10 W 0603			1
19	R6	SMD resistor 29.4 k Ω 1% 1/10 W 0603			1
20	R7, R8	SMD resistor 2.2 Ω 1% 1/2 W 1206			2
21	R4A, R4B	SMD resistor 1 m Ω 1% 1/4 W 1206	Vishay	RCV12061M00F KEA	2
22	R9	SMD resistor 24 k Ω 1% 1/4 W 1206			1
23	R1	SMD resistor 100 m Ω 1% 1/4 W 1206	Vishay	CRHA1206AF10 0MFKEF	1
24	R3	SMD resistor 15 k Ω 1% 1/10 W 0603			1

300 mA non-isolated ultra high-voltage buck evaluation board using ICE5BR3995BZ



Bill of materials

No.	Designator	Description	Manufacturer	Part number	Quantity
25	L2	Fixed inductor 390 μ H 1 A 0.6 Ω	Würth Elektronik	7447452391	1
26	L1	Fixed inductor 1 mH 500 mA 2.08 Ω THT	Würth Elektronik	768772102	1
27	Line, neutral, GND	PC test-point multipurpose THT, white	Keystone	5012	3
28	+18 V	PC test-point multipurpose THT, red	Keystone	5010	1
29	GND	PC test-point multipurpose THT, black	Keystone	5011	1

Test results

8 Test results

8.1 Efficiency

Table 3 Efficiency

Input (V AC/Hz)	Load percentage (%)	P _{IN} (W)	V _{OUT} (V DC)	I _{OUT} (A)	P _{OUT} (W)	Efficiency η (%)	Average efficiency η (%)
85 V AC/60 Hz	0	0.041	18.17	0	0		
	25	1.764	17.58	0.0746	1.312	74.35	72.1
	50	3.607	17.49	0.1495	2.615	72.52	
	75	5.476	17.44	0.2243	3.912	71.44	
	100	7.419	17.37	0.2992	5.198	70.07	
115 V AC/60 Hz	0	0.046	18.17	0	0		
	25	1.771	17.58	0.0746	1.312	74.08	72.53
	50	3.628	17.48	0.1495	2.613	72.03	
	75	5.411	17.42	0.2243	3.907	72.2	
	100	7.228	17.34	0.2993	5.19	71.8	
230 V AC/50 Hz	0	0.089	18.20	0	0		
	25	1.847	17.59	0.0746	1.312	71.05	72.19
	50	3.582	17.52	0.1495	2.62	73.15	
	75	5.379	17.44	0.2244	3.914	72.77	
	100	7.231	17.35	0.2993	5.191	71.79	
264 V AC/50 Hz	0	0.107	18.20	0	0		
	25	1.884	17.58	0.0747	1.313	69.68	71.34
	50	3.647	17.51	0.1496	2.62	71.83	
	75	5.395	17.44	0.2243	3.913	72.52	
	100	7.277	17.34	0.2992	5.189	71.31	
460 V AC/50 Hz	0	0.257	18.41	0	0		
	25	2.168	17.56	0.0747	1.311	60.47	64.9
	50	4.028	17.48	0.1495	2.613	64.88	
	75	5.848	17.4	0.2243	3.903	66.75	
	100	7.675	17.3	0.2993	5.179	67.48	

Note: A dummy load (R9 = 24 kΩ) was placed on the board for output voltage regulation at no-load condition.

Test results

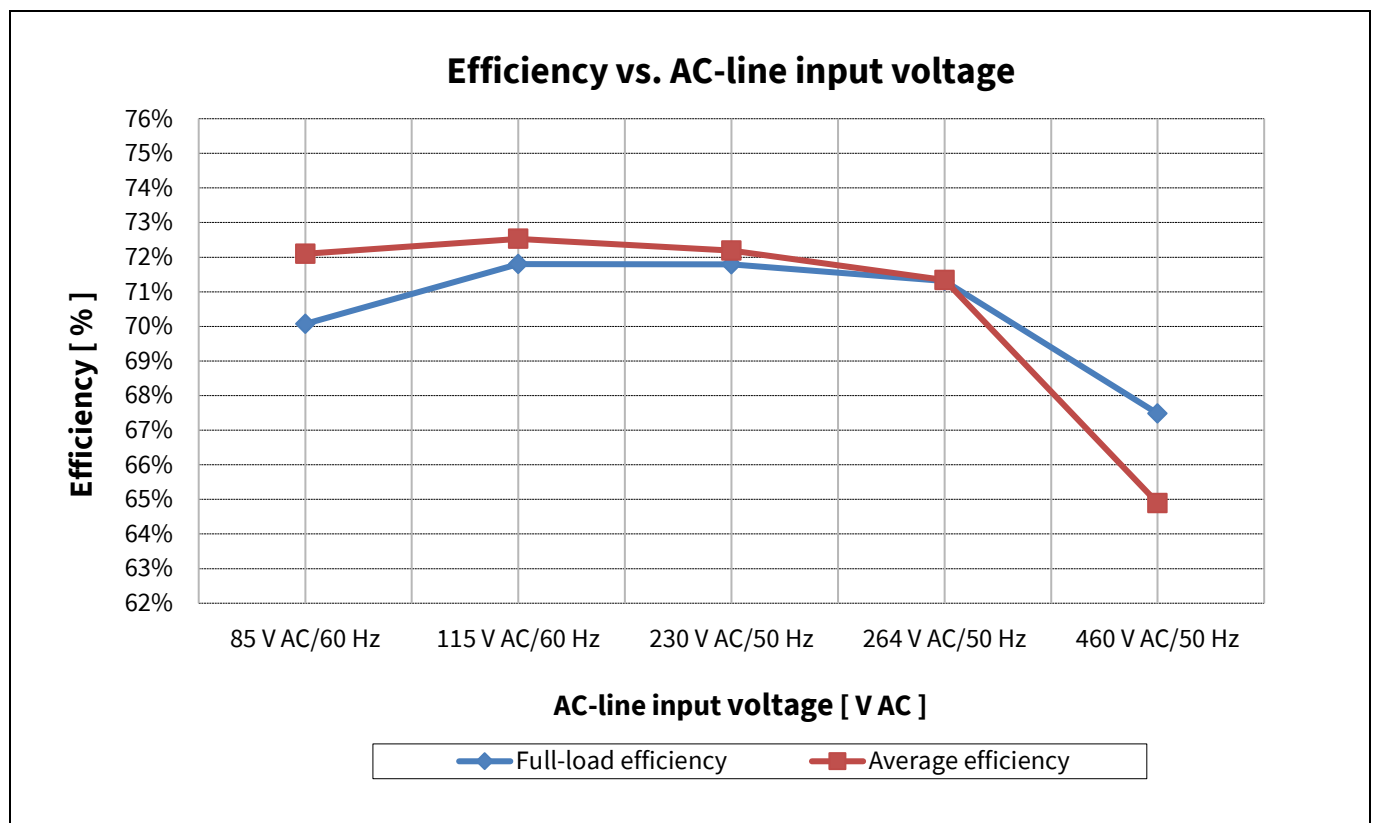

Figure 5 Efficiency vs. AC-line input voltage

8.2 Standby power

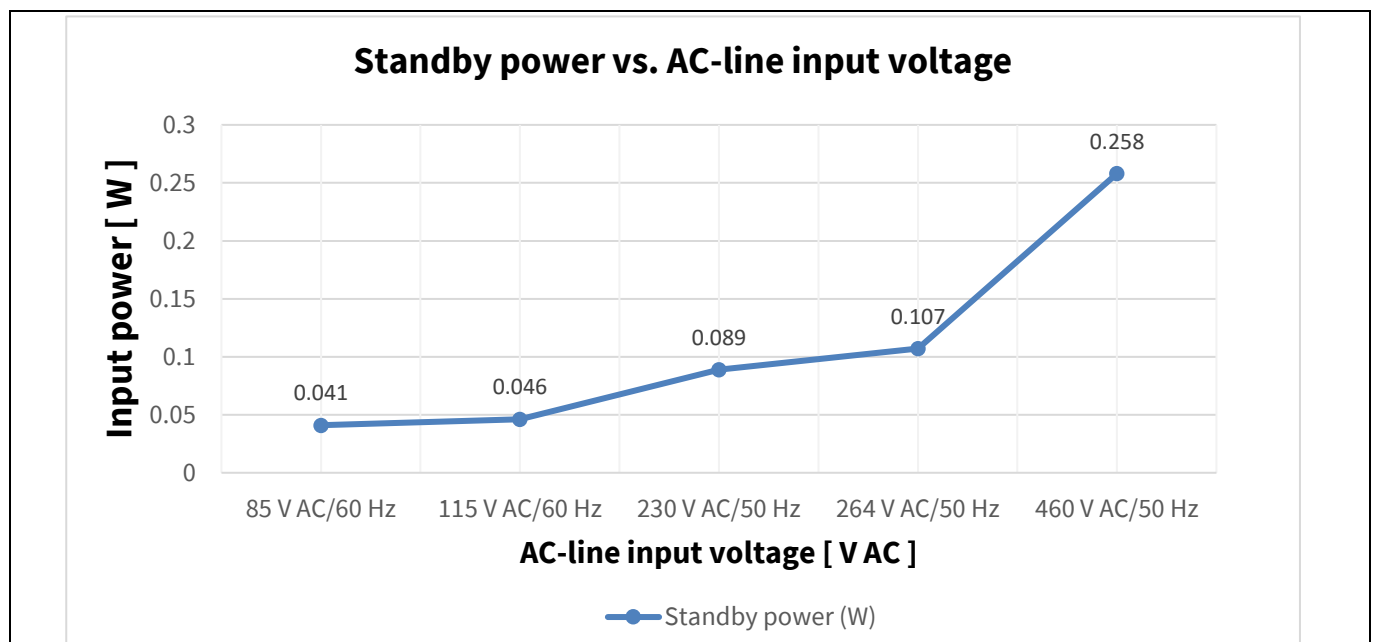

Figure 6 Standby power at no-load vs. AC-line input voltage

Test results

8.3 Line regulation at full load

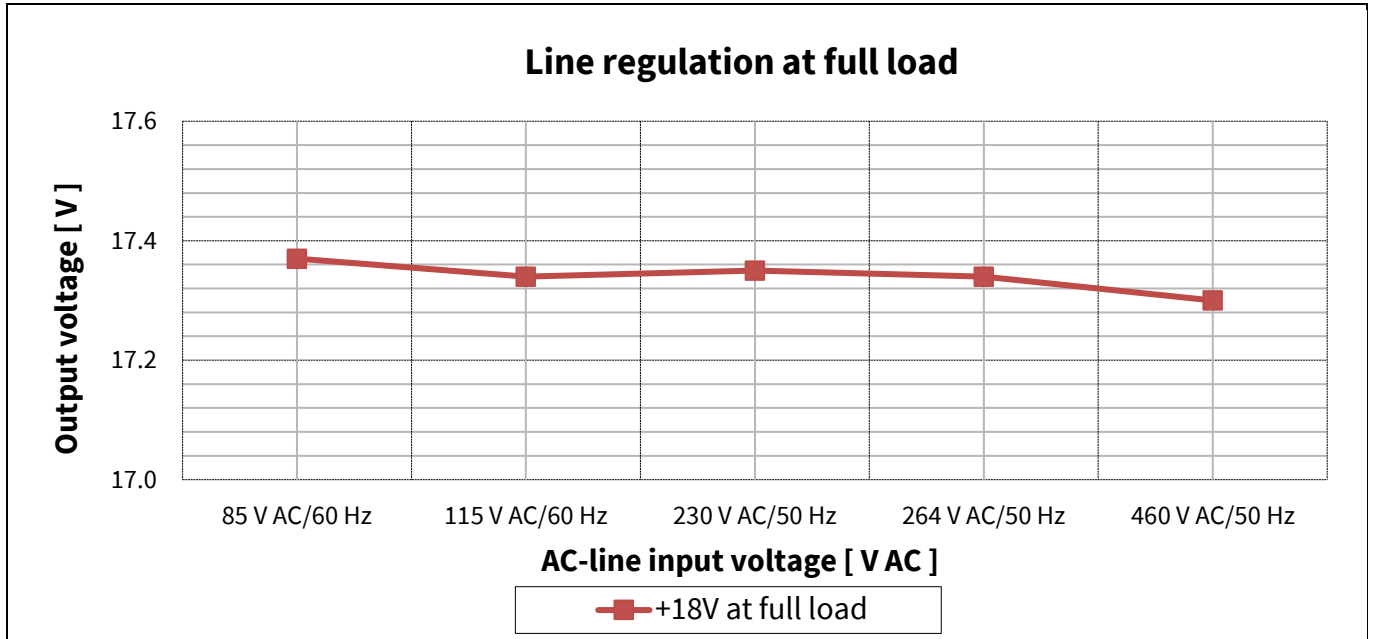

Figure 7 Line regulation V_{out} vs. AC-line input voltage

8.4 Load regulation

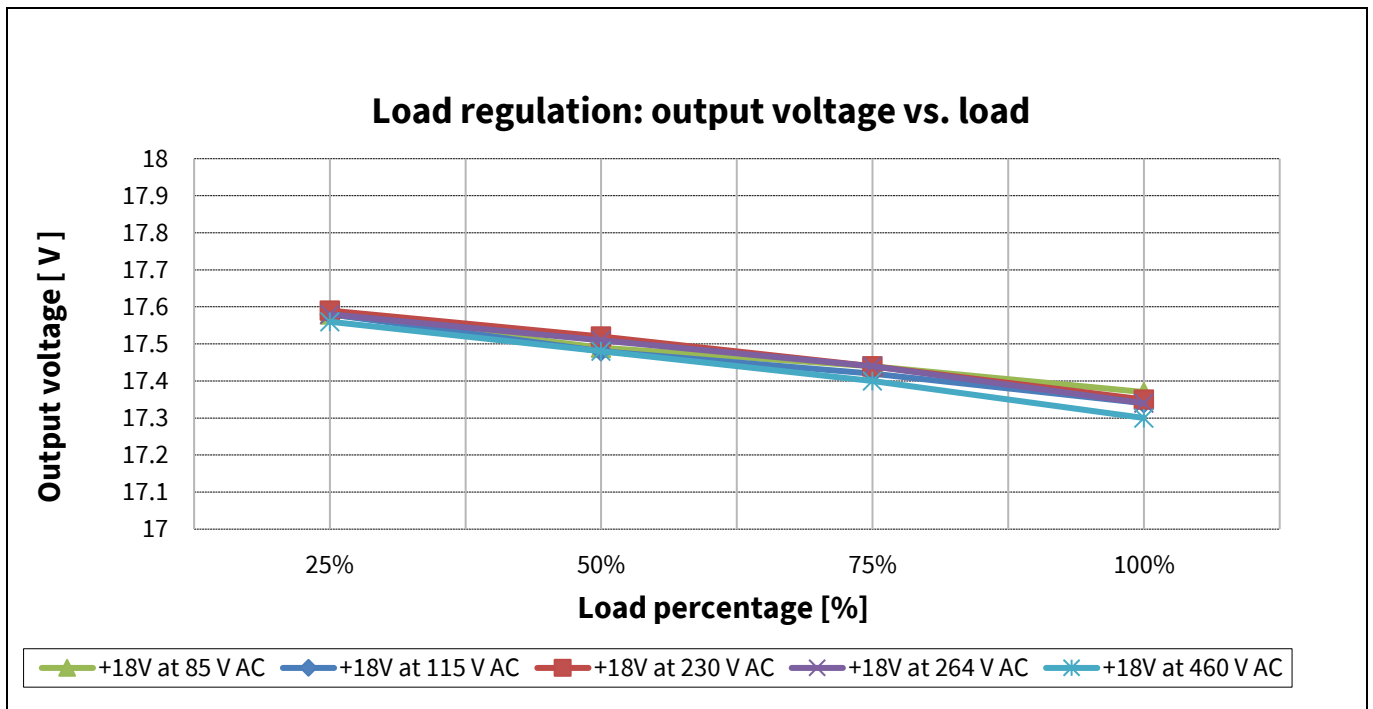

Figure 8 Load regulation V_{out} vs. output power

Test results

8.5 Surge immunity (EN 61000-4-5)

EN 61000-4-5 installation class 3 (± 1 kV for line-to-line DM). A test failure is defined as a non-recoverable and/or system auto-restart.

Table 4 Surge immunity test result

Description	Test	Level		Number of strikes				Test result
				0°	90°	180°	270°	
115/230 V AC, 300 mA	DM	+/- 1 kV	L → N	3	3	3	3	Pass

8.6 Conducted emissions (EN 55022 class B)

Conducted EMI was measured by Schaffner (SMR4503) and followed the test standard of EN 55022 (CISPR 22) class B. The evaluation board was connected to resistive load (300 mA) with input voltage of 115 V AC and 230 V AC.

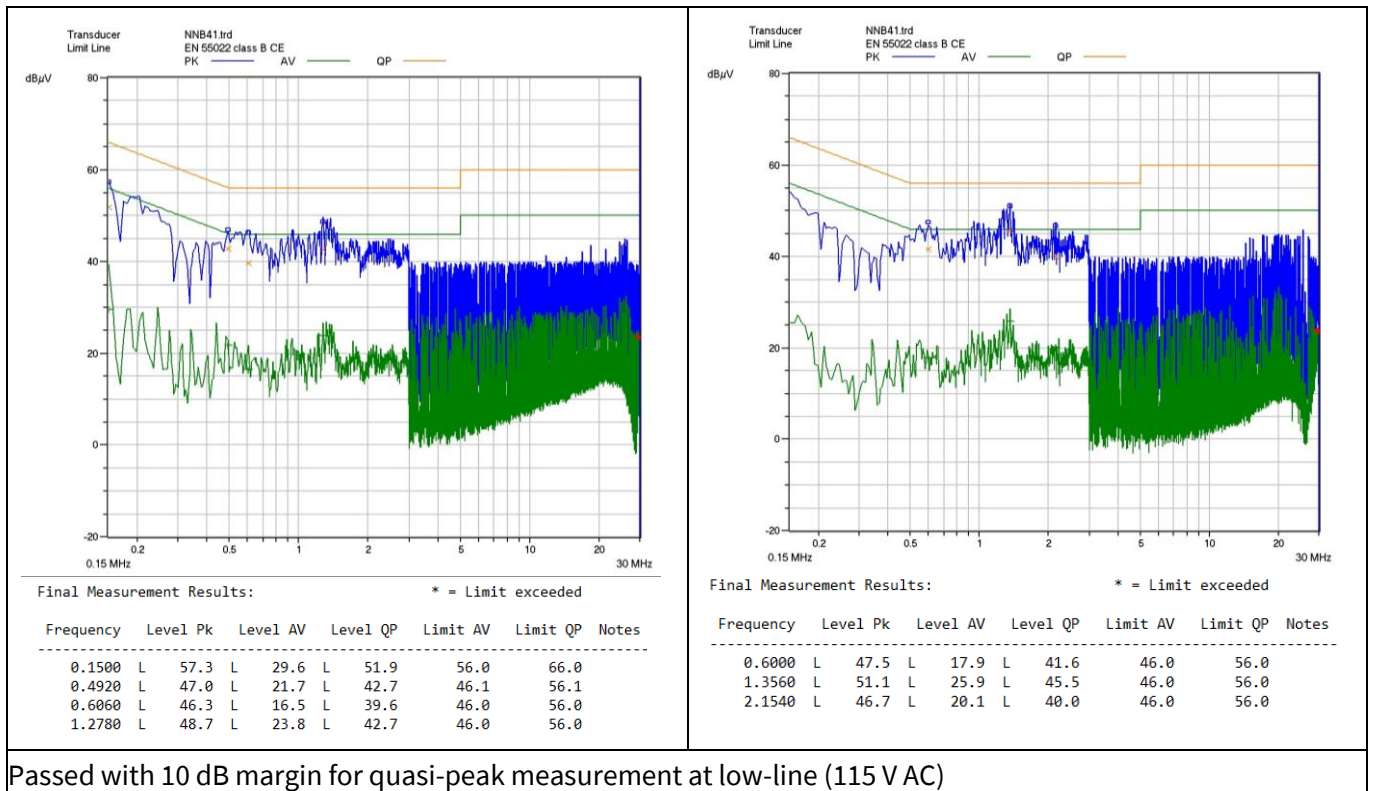

Figure 9 Conducted emissions at 115 V AC with full load

Test results

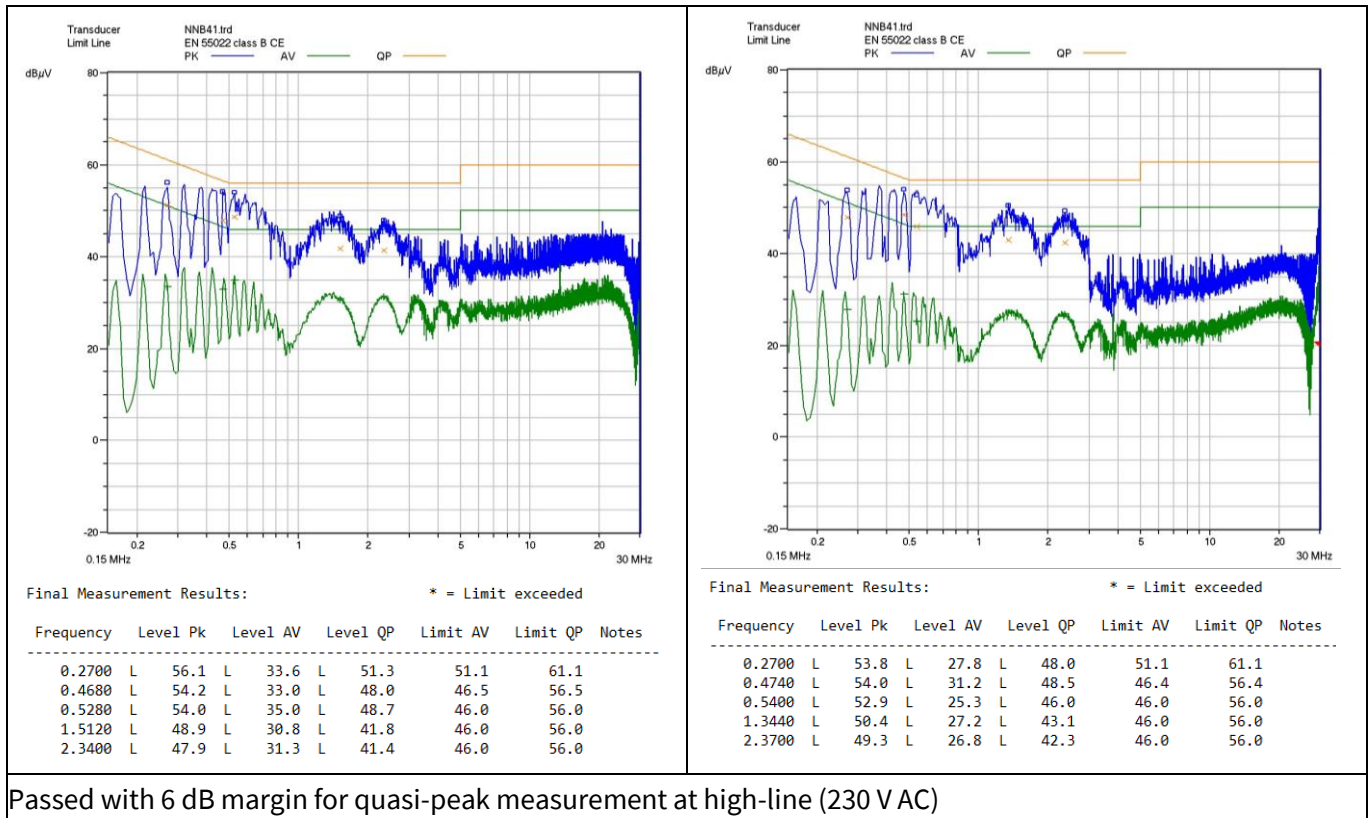

Figure 10 Conducted emissions at 230 V AC with full load

8.7 Thermal measurement

The thermal test of the open-frame evaluation board was done using an infrared thermography camera (FLIR-T62101) at an ambient temperature of 25°C. The measurements were taken after one hour running at full load.

Table 5 Hottest temperature of evaluation board

No.	Major component	85 V AC (°C)	460 V AC (°C)
1	IC1 (ICE5BR3995BZ)	51.9	72.7
2	D4 (freewheeling diode)	68.1	78.2
3	L2 (inductor)	61.1	85.5
4	R _{CS} (current sense resistor)	50.9	56.1
5	R2* (antisaturation resistor)	84.6	94.7

*R2 limits the current through the output inductor (L2) to avoid saturation during the start-up phase and output short condition.

Test results

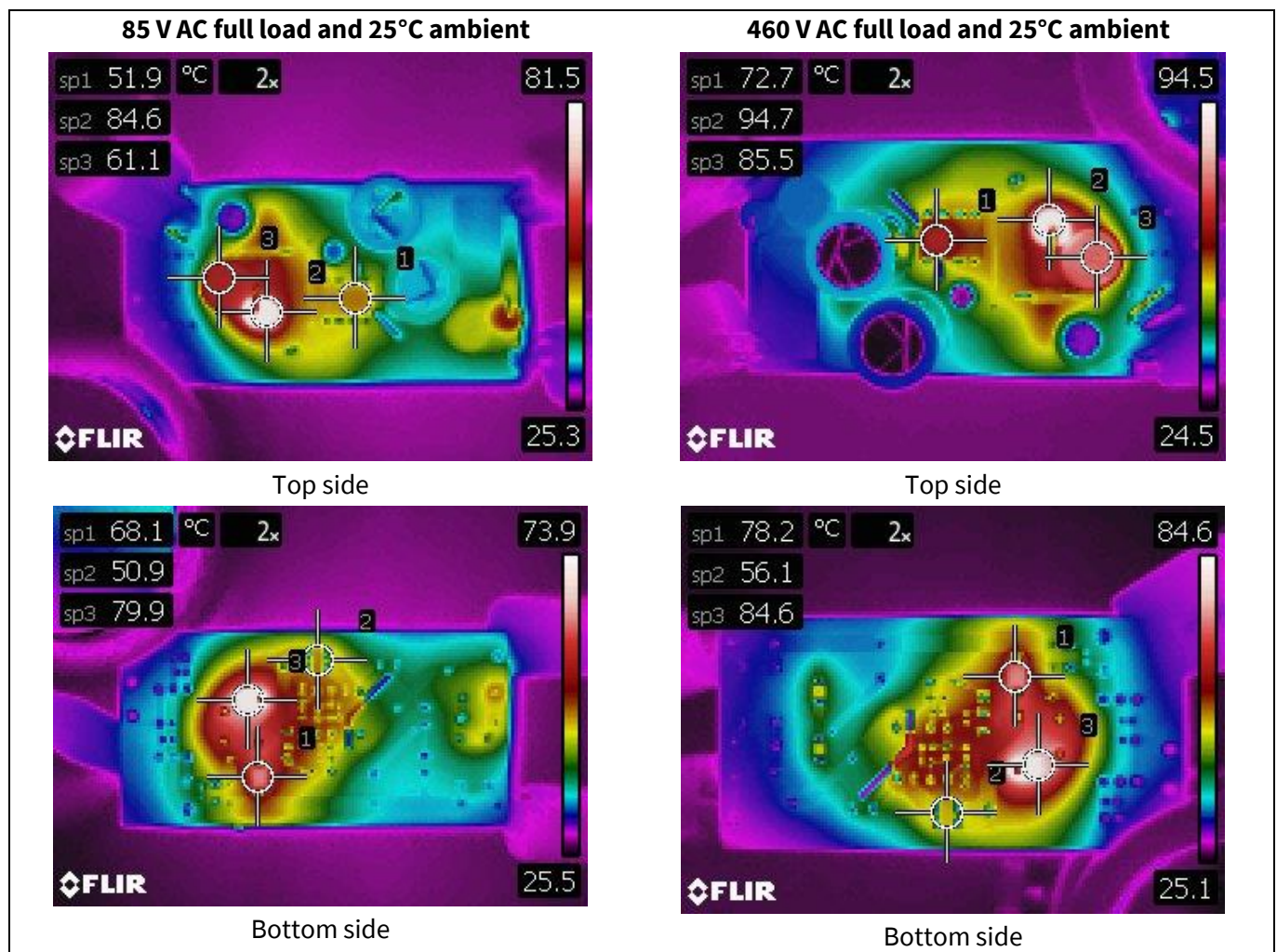

Figure 11 Infrared thermal image of EVAL_5BR3995BZ_BUCK1

Waveforms and scope plots

9 Waveforms and scope plots

All waveforms and scope plots were recorded with a Teledyne LeCroy 606Zi oscilloscope.

9.1 Start-up with maximum load

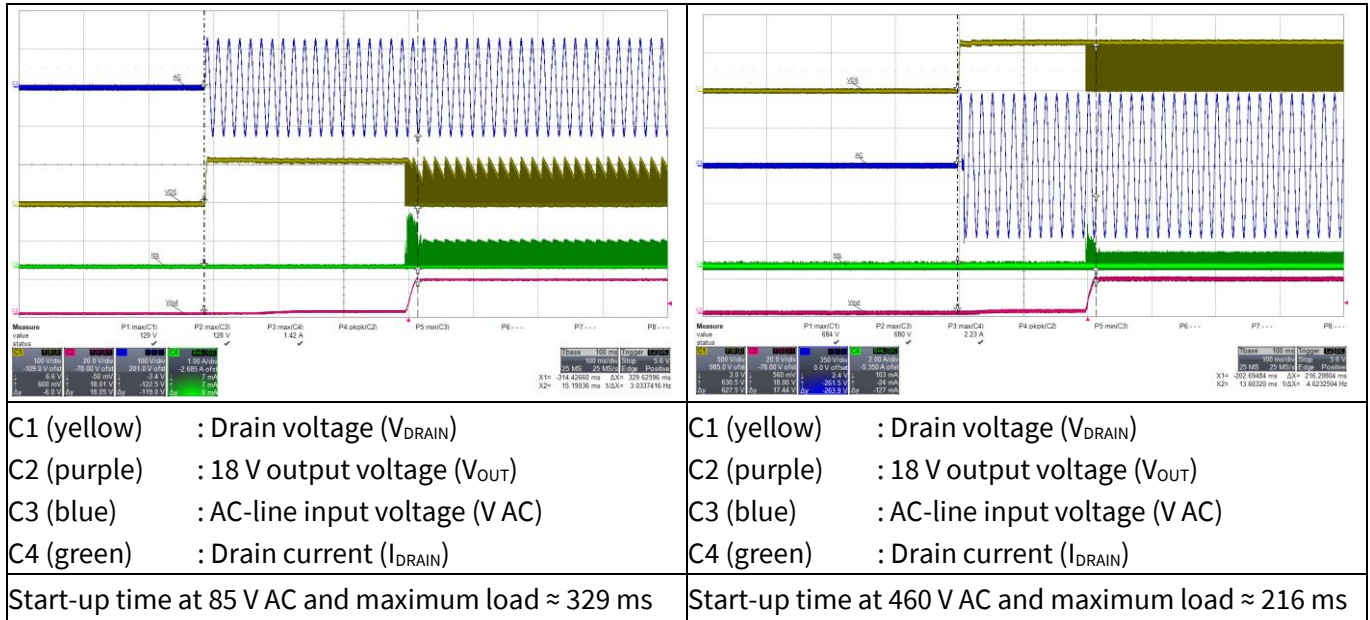

Figure 12 Start-up

9.2 Soft-start

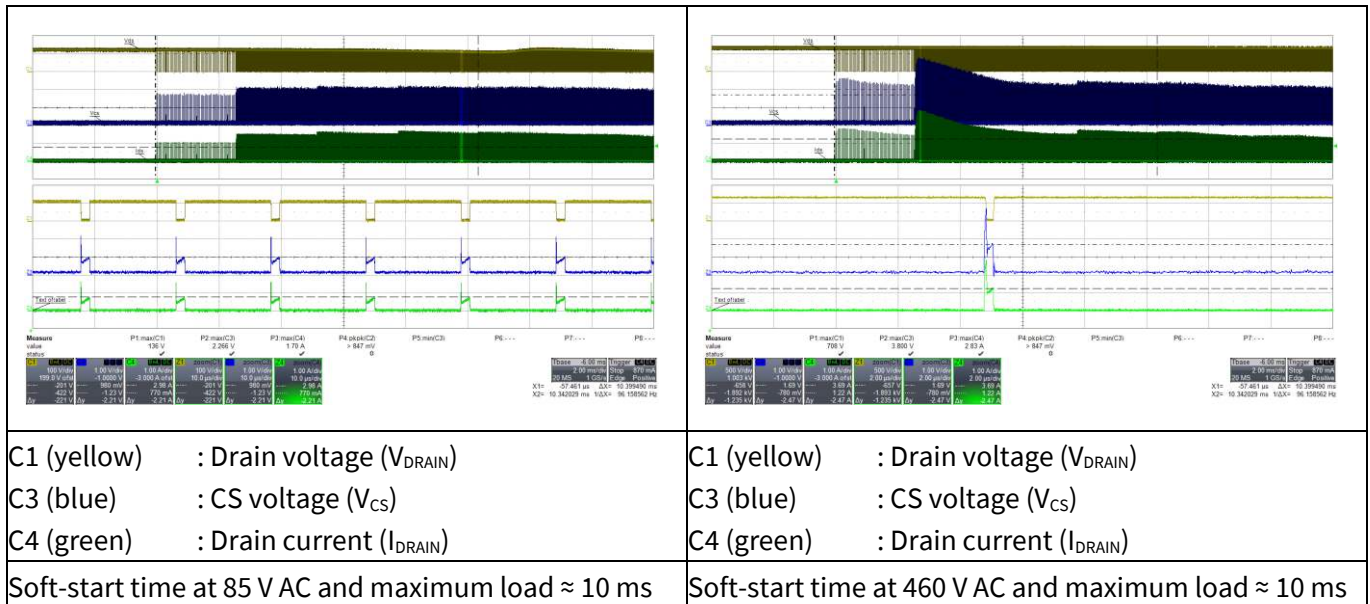

Figure 13 Soft-start

Waveforms and scope plots

9.3 Drain voltage and current at maximum load

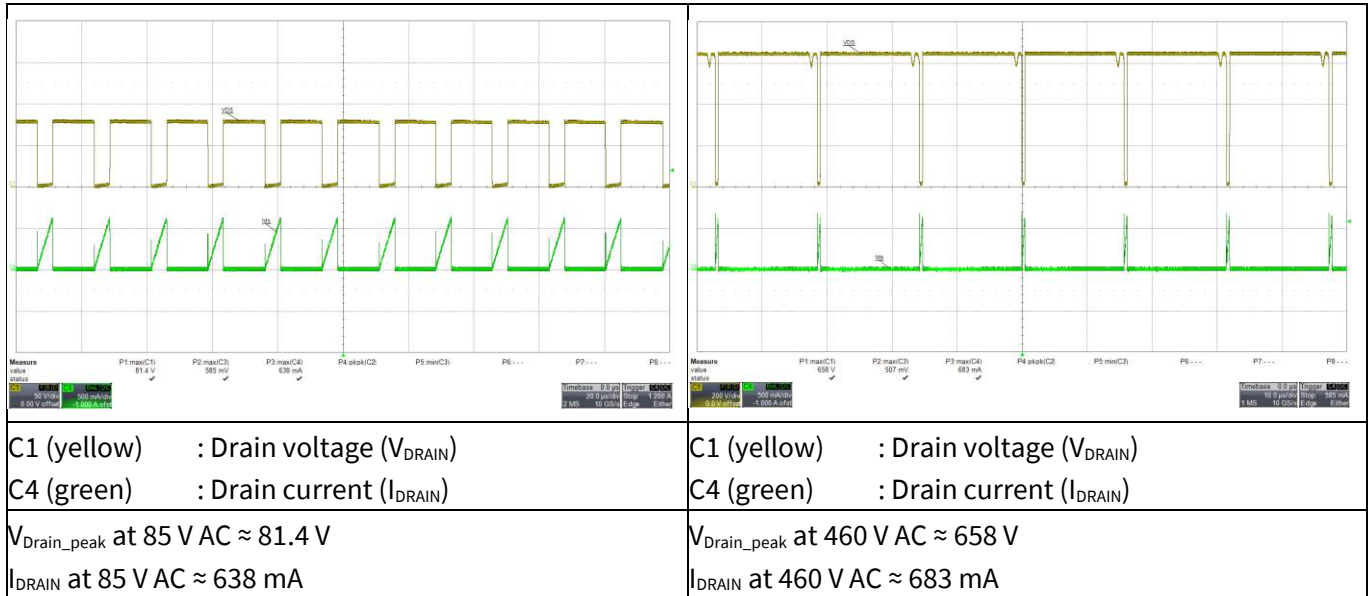

Figure 14 Drain and CS voltage at maximum load

9.4 Output ripple voltage at maximum load

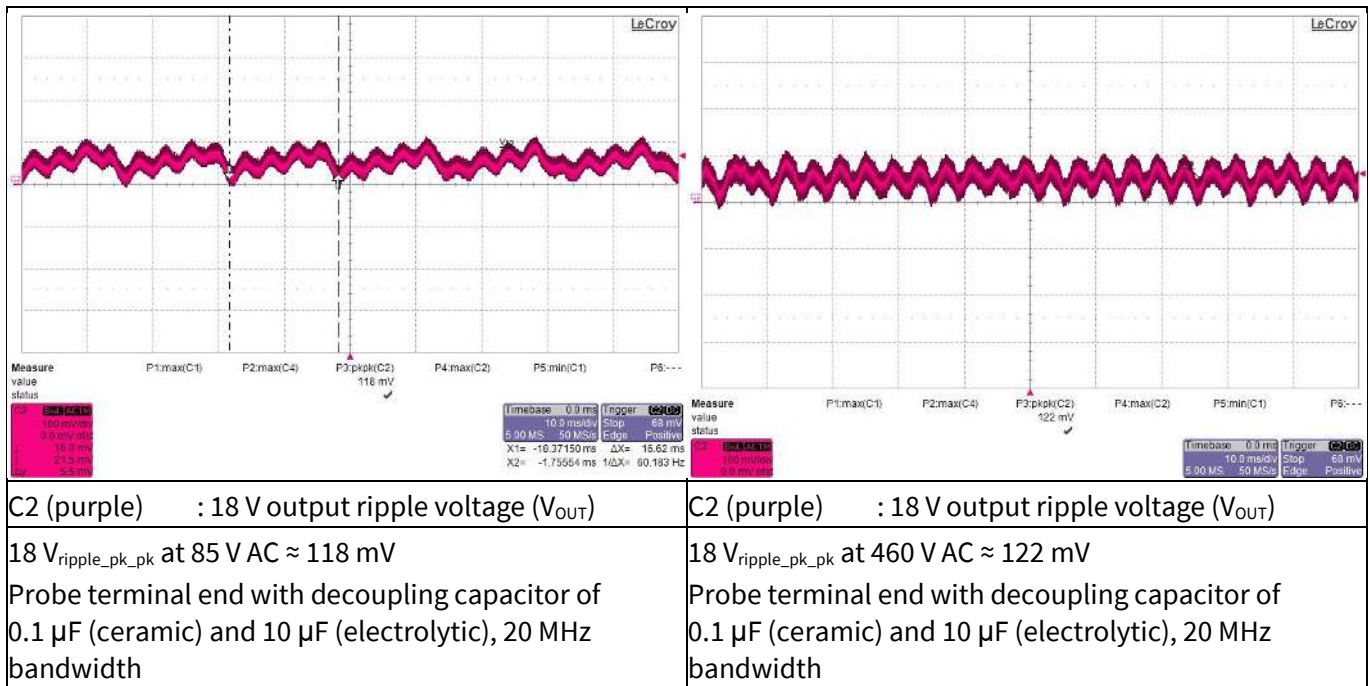

Figure 15 Output ripple voltage at maximum load

Waveforms and scope plots

9.5 ABM operation

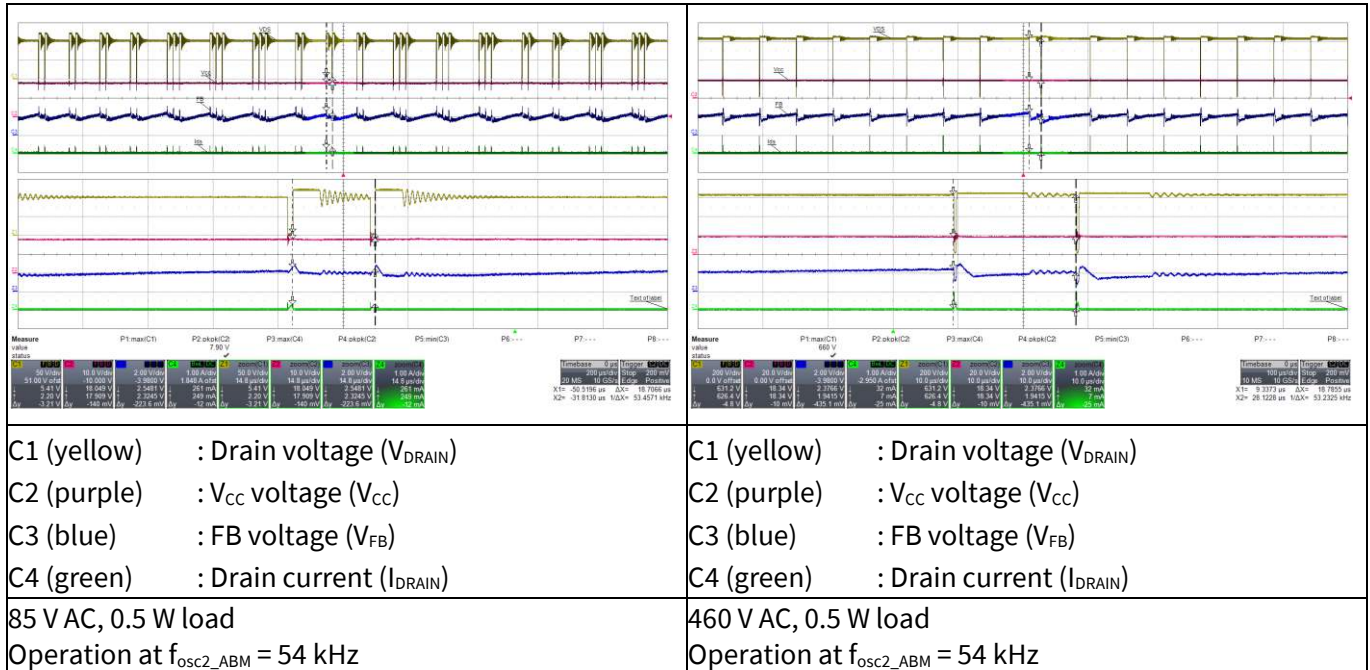

Figure 16 ABM operation

9.6 Overload protection (odd-skip auto-restart)

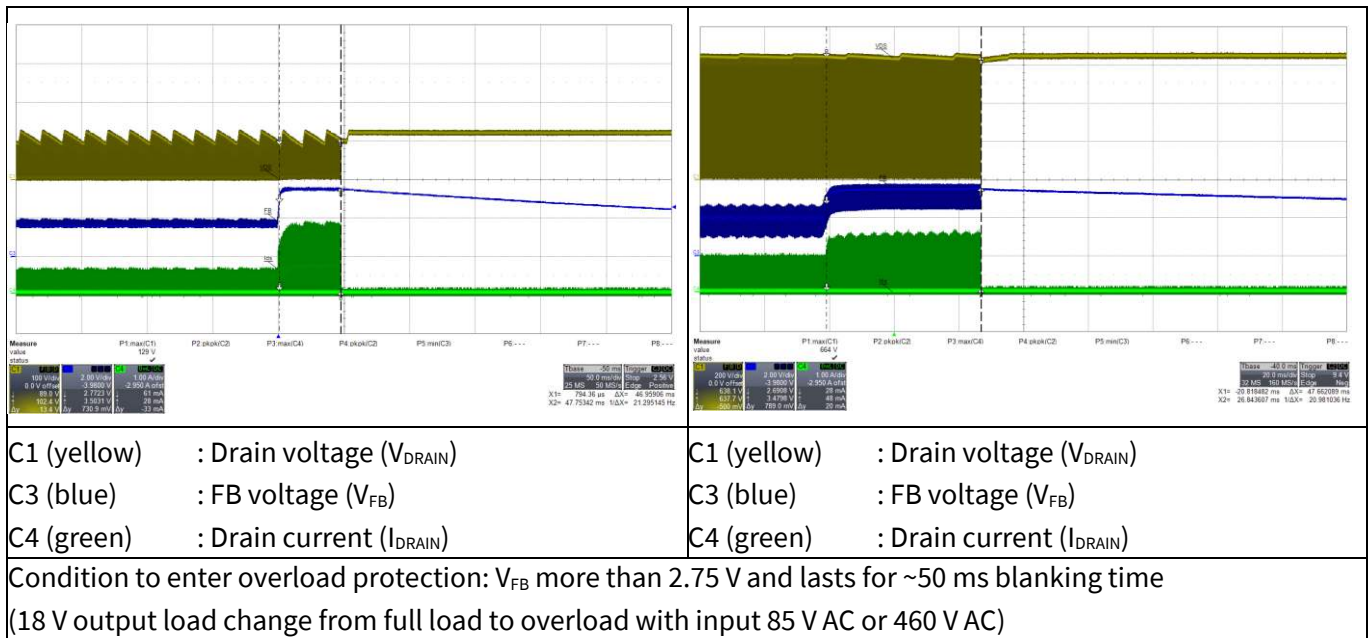
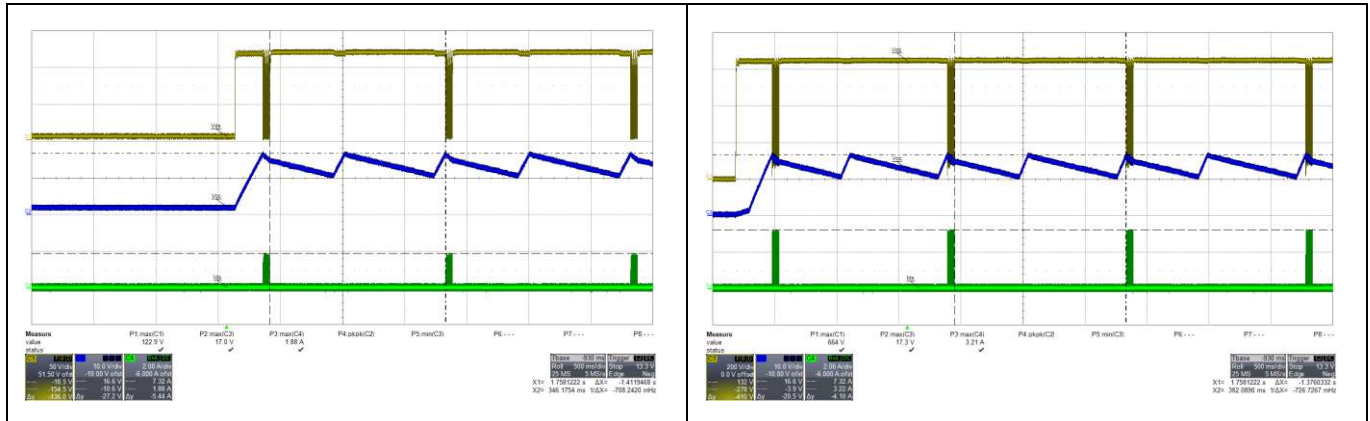

Figure 17 Overload protection

9.7 Output short test



C1 (yellow) : Drain voltage (V_{DRAIN})	C1 (yellow) : Drain voltage (V_{DRAIN})
C3 (blue) : V_{CC} voltage (V_{CC})	C3 (blue) : V_{CC} voltage (V_{CC})
C4 (green) : Drain source current (I_{DS})	C4 (green) : Drain source current (I_{DS})
IC enters into overload protection in odd-skip auto-restart mode	

Figure 18 Output short test

10 Design example A

In this design example, two linear regulators will be placed in series on the board. The main output is still 18 V. The 15 V output able to supply up to 200 mA is obtained from the main output through IC2, and the 5 V output able to supply up to 100 mA is obtained from the 15 V output through IC3. The additional circuit is as shown below.

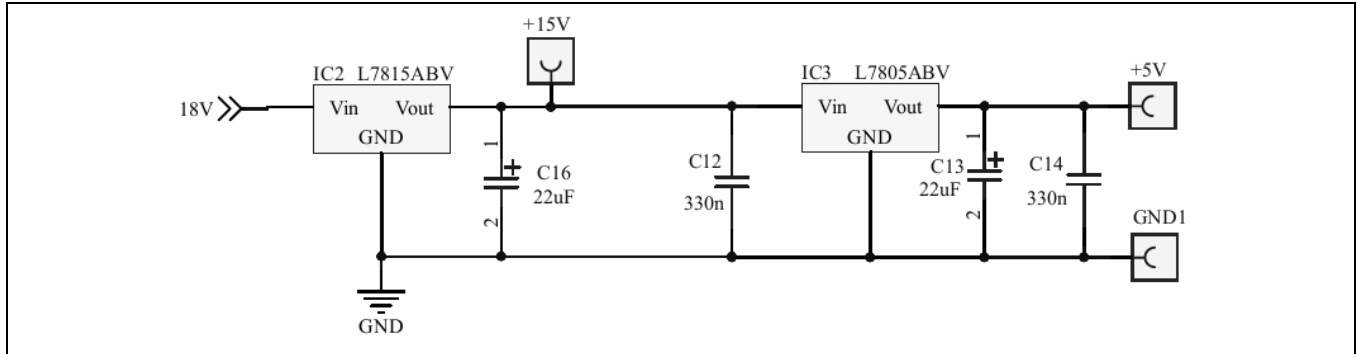

Figure 19 Additional circuit for design example A

Note: Components in additional circuit shown in Figure 19 are not mounted on the actual evaluation board.

10.1 Specification of design example A

Because the 12 V output and 5 V output are subordinated to the main output 18 V, total output current should not exceed the maximum capacity of the main output current. The specification of this design example is below.

Table 6 Specification of design example A

Description	Symbol	Value	Comments
Output voltage 1	V_{o1}	18 V	Main output
Max. output current 1	I_{o1}	0.1 A	
Output voltage 2 (via LDO)	V_{o2}	15 V	Derived from 18 V output
Max. output current 2	I_{o2}	0.1 A	
Output voltage 3 (via LDO)	V_{o3}	5 V	Derived from 15 V output
Max. output current 3	I_{o3}	0.1 A	

10.2 Full-load efficiency

Additional power loss caused by LDO circuits will reduce overall efficiency.

Table 7 Full-load efficiency – example A

Input (V AC/Hz)	P_{IN} (W)	V_{o1} (V DC)	I_{o1} (A)	V_{o2} (V DC)	I_{o2} (A)	V_{o3} (V DC)	I_{o3} (A)	P_{OUT} (W)	Efficiency η
85 V AC/60 Hz	7.80	17.843	0.1	14.942	0.1	5.075	0.1	3.786	49%
115 V AC/60 Hz	7.64	17.843	0.1	14.942	0.1	5.075	0.1	3.786	50%
230 V AC/60 Hz	7.62	17.875	0.1	14.942	0.1	5.087	0.1	3.790	50%
264 V AC/60 Hz	7.69	17.875	0.1	14.942	0.1	5.087	0.1	3.790	49%
460 V AC/60 Hz	8.21	17.859	0.1	14.942	0.1	5.087	0.1	3.789	46%

300 mA non-isolated ultra high-voltage buck evaluation board using ICE5BR3995BZ



Design example B

No.	Designator	Description	Manufacturer	Part number	Quantity
3	C4	Ceramic capacitor 47 nF 25 V X7R 0603			1
4	C5	Ceramic capacitor 2.2 nF 25 V X7R 0603			1
5	C7	Ceramic capacitor 1 μ F 25 V X7R 1206			1
6	C9	Aluminum capacitor 47 μ F 20% 50 V radial			1
7	C10	Aluminum capacitor 220 μ F 20% 25 V radial			1
8	C11, C13, C15	Ceramic capacitor 0.1 μ F 50 V X7R 0603			3
9	C12, C14	Aluminum capacitor 10 μ F 20% 50 V radial			2
10	D1	Bridge rectifier 1-phase 1 kV 1 A 4SOPA	Diodes	ABS10A-13	1
11	D2	General-purpose diode 100 V 150 mA SOD-123	Diodes	BAV16W-7-F	1
12	D3	General-purpose diode 1 kV 1 A SMA DO-214AC		S1M	1
13	D4	Ultrafast power rectifier	STMicroelectronics	STTH3R06S	1
14	F1	Mounted fuse board 1 A 300 V AC radial			1
15	IC1	Gen5 FF CoolSET™ DIP7	Infineon Technologies	ICE5BR4780BZ	1
16	L1	Fixed inductor 1000 μ H 0.6 A 1.27 Ω	Würth Elektronik	7447452102	1
17	L2	Fixed inductor 150 μ H 2 A	Würth Elektronik	7447480151	1
18	R1	Resistor 50 m Ω 300 mW 1206	Vishay	CRHA1206AF50M0FKE F	1
19	R2	SMD resistor 15 k Ω 1% 1/10 W 0603			1
20	R4	SMD resistor 29.4 k Ω 1% 1/10 W 0603			1
21	R5	SMD resistor 220 k Ω 1% 1/10 W 0603			1
22	R7, R8	SMD resistor 1.2 Ω 1% 1/2 W 1206			2
23	R9	SMD resistor 10 k Ω 1% 1/4 W 1206			1
24	R10	SMD resistor 51 k Ω 1% 1/10 W 0603			1
25	VAR1	S07K275E2/275 V AC/10%	Epcos	B72207S2271K101	1

Design example B

No.	Designator	Description	Manufacturer	Part number	Quantity
26	Line, neutral	PC test-point multipurpose THT, white	Keystone	5012	2
27	GND1	PC test-point multipurpose THT, black	Keystone	5011	1
28	+15 V	PC test-point multipurpose THT, red	Keystone	5010	1

11.4 Test results of design example B

11.4.1 Efficiency and standby power

Table 10 Efficiency and standby power – design example B

Input (V AC/Hz)	Load percentage (%)	P _{IN} (W)	V _{OUT} (V DC)	I _{OUT} (A)	P _{OUT} (W)	Efficiency η (%)	Average efficiency η (%)
85 V AC/60 Hz	0	0.055	15.796	0.000	/	/	82.77
	25	2.432	15.046	0.134	2.021	83.09	
	50	4.977	14.984	0.276	4.130	82.97	
	75	7.475	14.953	0.414	6.191	82.82	
	100	9.868	14.906	0.544	8.113	82.22	
115 V AC/60 Hz	0	0.056	15.765	0.000	/	/	83.50
	25	2.421	15.046	0.134	2.021	83.46	
	50	4.934	14.984	0.276	4.130	83.70	
	75	7.413	14.953	0.414	6.191	83.51	
	100	9.745	14.921	0.544	8.122	83.34	
230 V AC/50 Hz	0	0.058	15.797	0.000	/	/	83.23
	25	2.468	15.093	0.134	2.027	82.13	
	50	4.982	15.046	0.276	4.147	83.23	
	75	7.428	15.015	0.414	6.216	83.69	
	100	9.716	14.968	0.544	8.147	83.85	
264 V AC/50 Hz	0	0.059	15.796	0.000	/	/	82.74
	25	2.488	15.093	0.134	2.027	81.47	
	50	5.016	15.046	0.276	4.147	82.67	
	75	7.462	15.015	0.414	6.216	83.30	
	100	9.753	14.968	0.544	8.147	83.53	

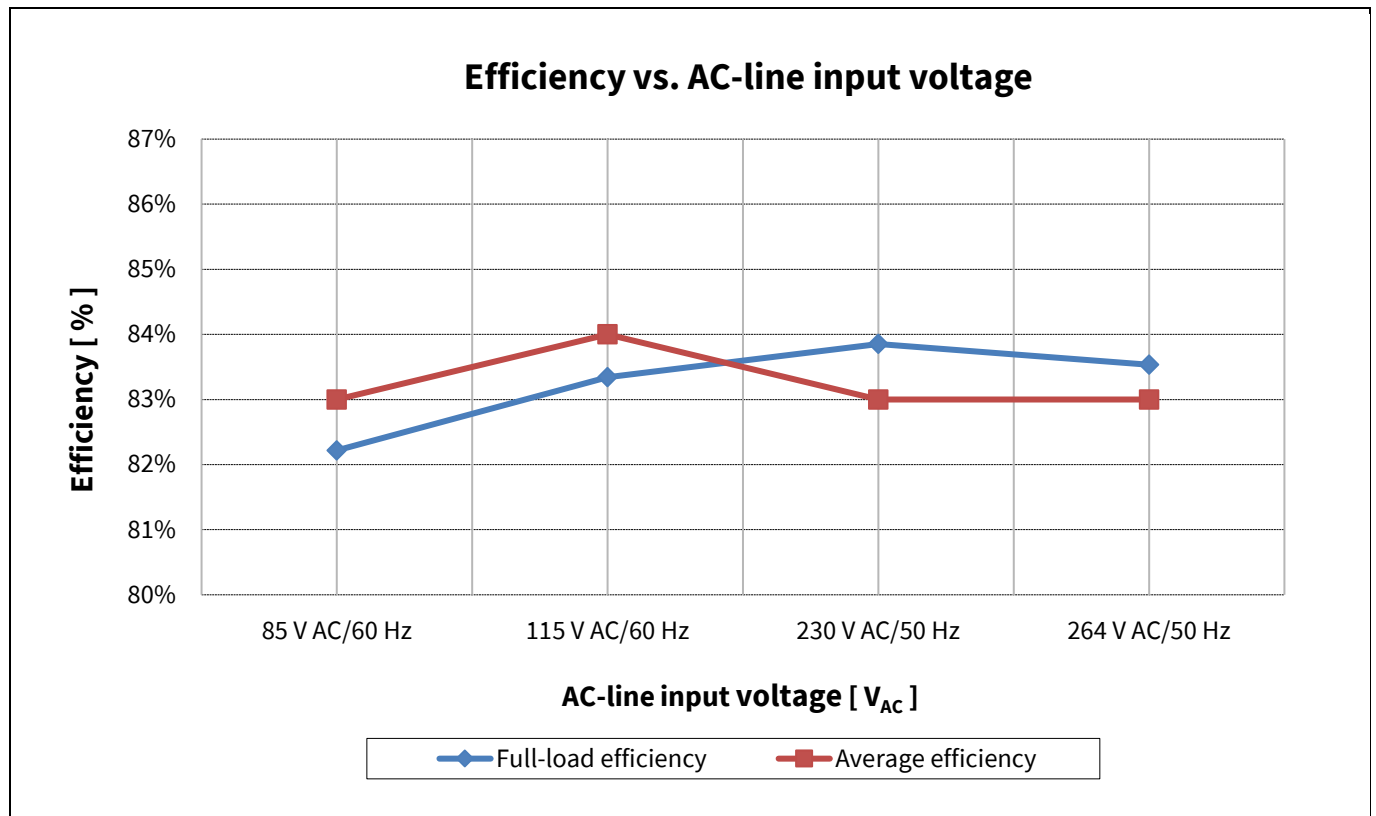

Figure 21 Efficiency vs. AC-line input voltage – design example B

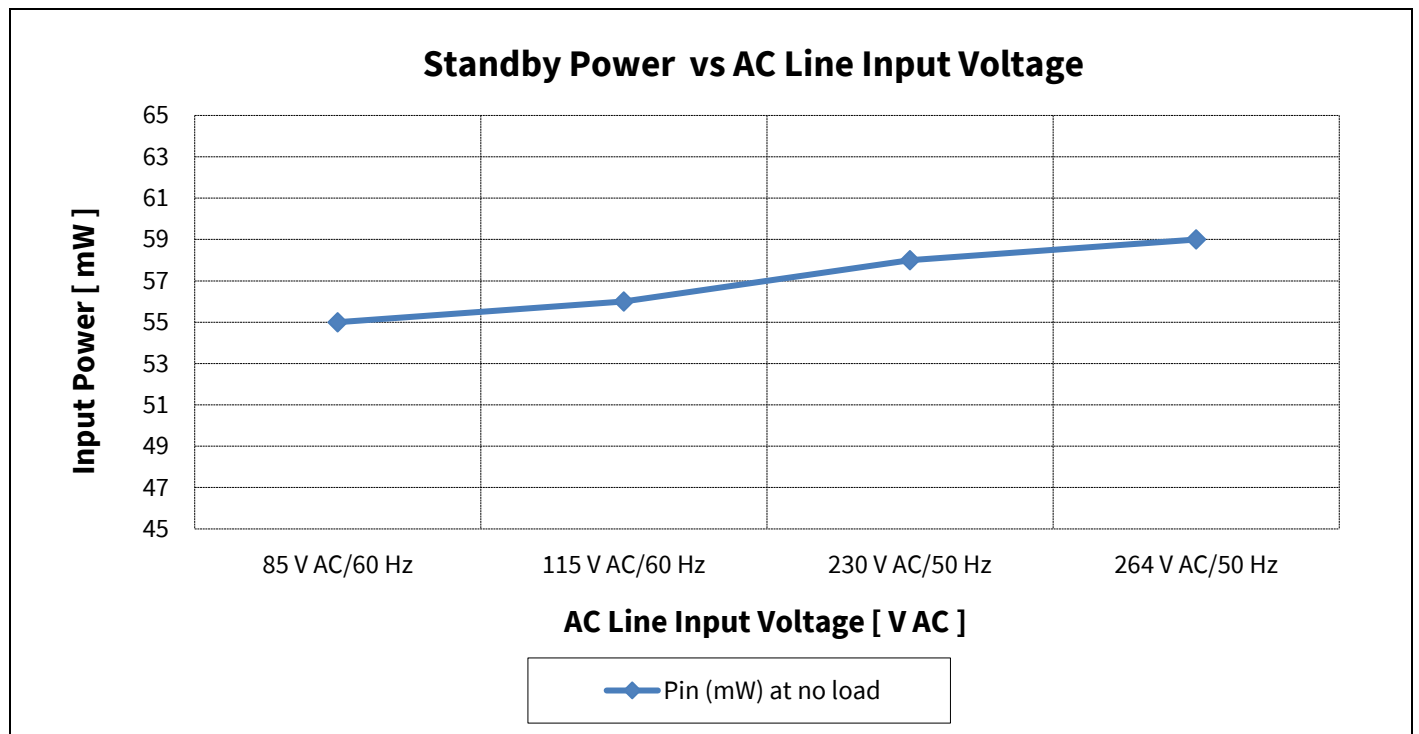

Figure 22 Standby power vs. AC-line input voltage – design example B

Design example B

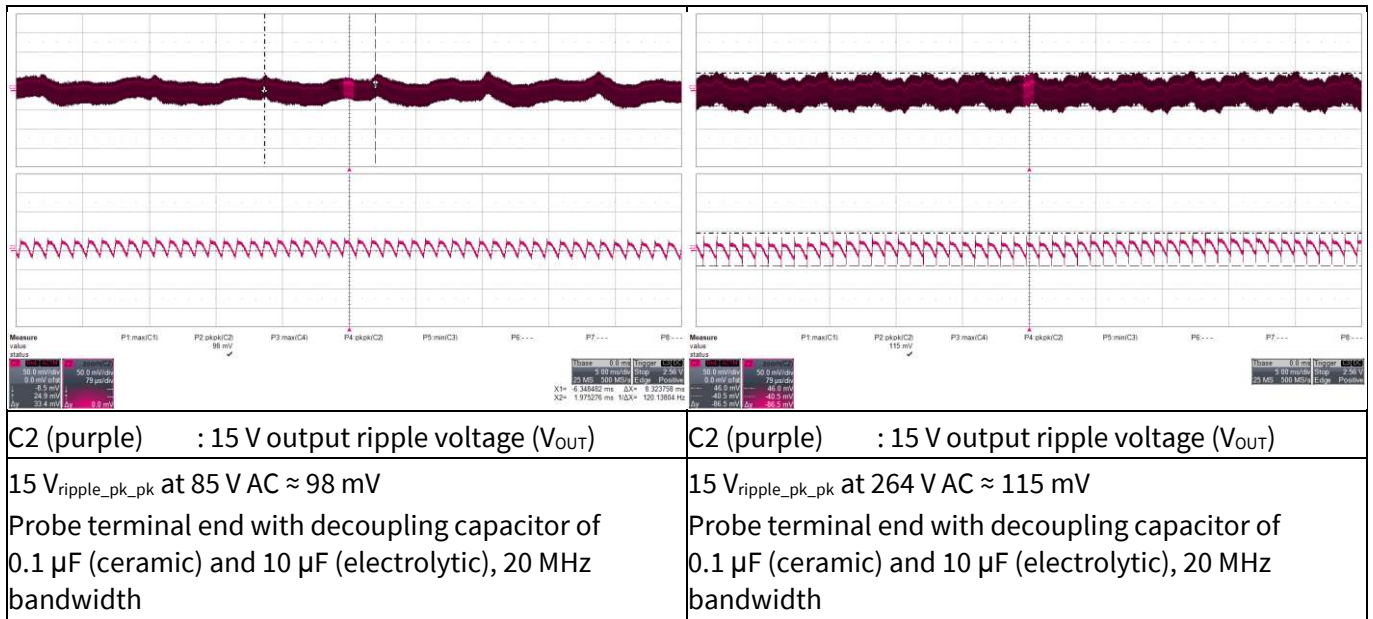

Figure 23 Output ripple voltage at maximum load – design example B

11.4.2 Output voltage regulation – design example B

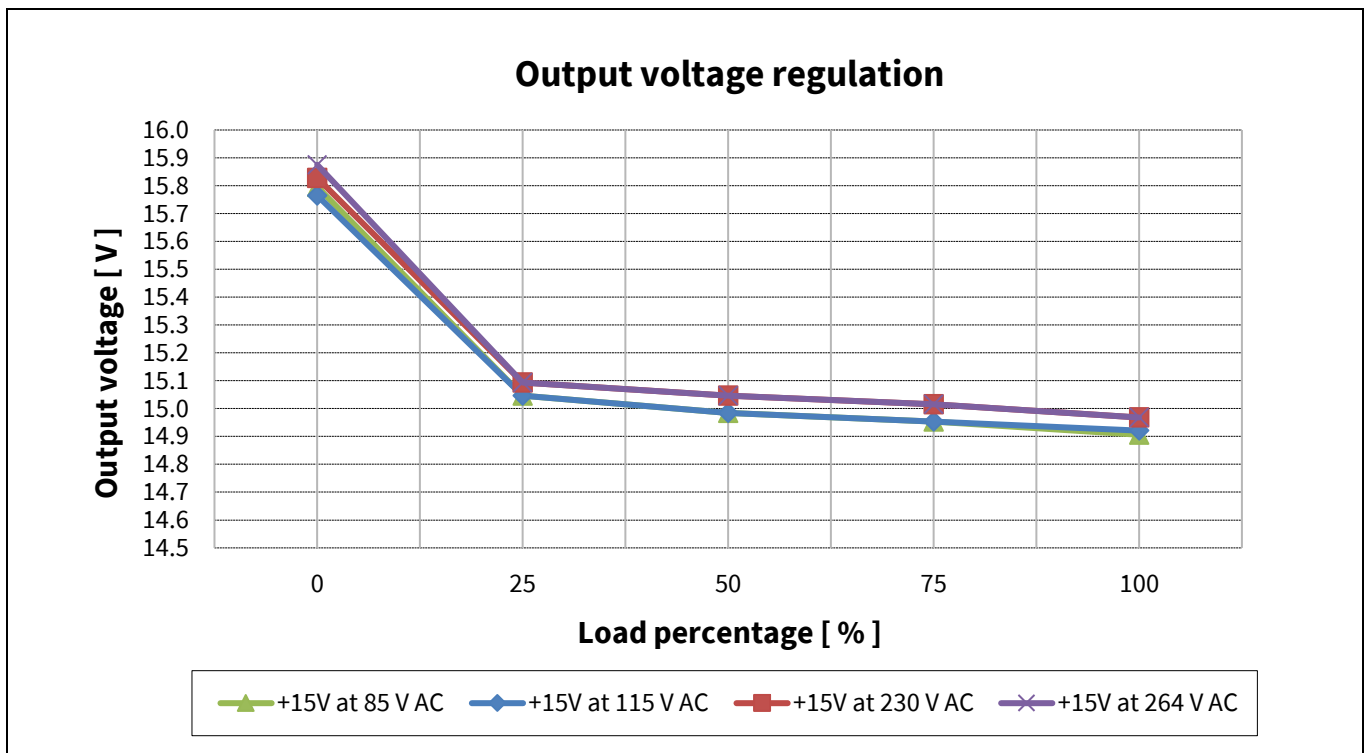

Figure 24 Output voltage regulation – design example B

11.5 Thermal measurement – design example B

The thermal test of the open-frame evaluation board was done using an infrared thermography camera (FLIR-T62101) at an ambient temperature of 25°C. The measurements were taken after one hour running at full load (550 mA).

Table 11 Hottest temperature of design example B

No.	Major component	85 V AC (°C)	264 V AC (°C)
1	IC1 (ICE5BR3995BZ)	67.3	56.8
2	D4 (freewheeling diode)	67.3	68.6
3	L2 (inductor)	55.0	68.5
4	Ambient	24.6	24.9

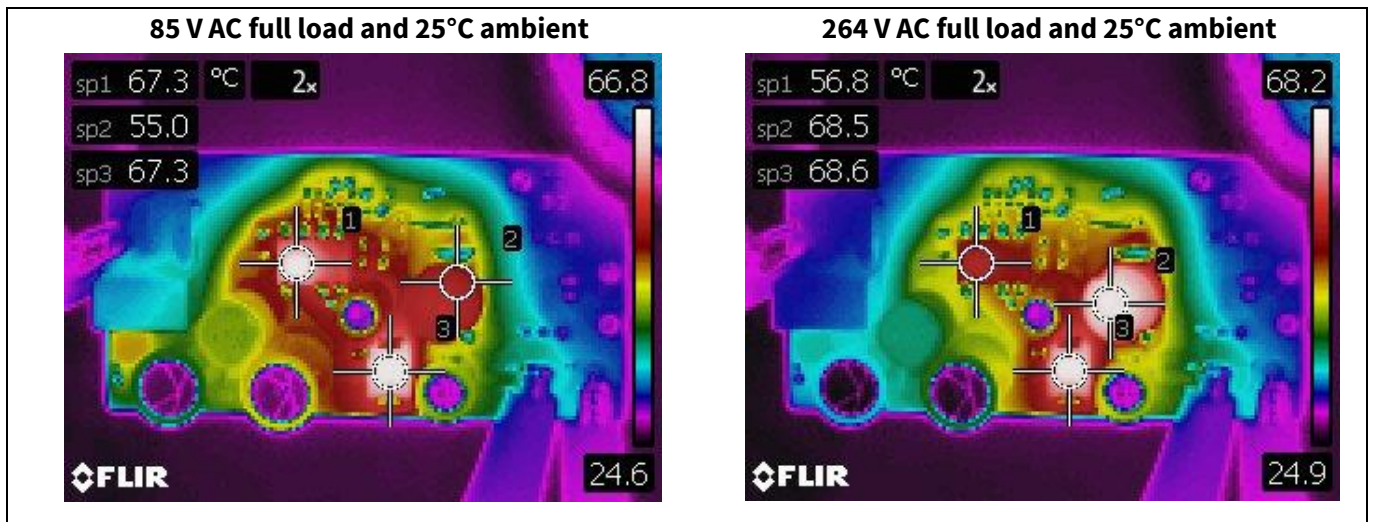

Figure 25 Infrared thermal image of design example B

12 References

- [1] [Fixed-frequency 800 V / 950 V CoolSET™, ICE5xRxxxxxZ Datasheet](#)
- [2] [Design guide 5th generation CoolSET™ high-voltage buck ICE5BRxxxxBZ](#)

Revision history

Revision history

Document version	Date of release	Description of changes
V 1.0	2022-06-15	Initial release
V 1.1	2022-08-05	BOM and references updated

Other Trademarks

All referenced product or service names and trademarks are the property of their respective owners.

Edition 2022-08-05

Published by

Infineon Technologies AG

81726 Munich, Germany

© 2022 Infineon Technologies AG.

All Rights Reserved.

Do you have a question about this document?

Email: erratum@infineon.com

Document reference

ER_2101_PL21_2106_103333

IMPORTANT NOTICE

The information contained in this application note is given as a hint for the implementation of the product only and shall in no event be regarded as a description or warranty of a certain functionality, condition or quality of the product. Before implementation of the product, the recipient of this application note must verify any function and other technical information given herein in the real application. Infineon Technologies hereby disclaims any and all warranties and liabilities of any kind (including without limitation warranties of non-infringement of intellectual property rights of any third party) with respect to any and all information given in this application note.

The data contained in this document is exclusively intended for technically trained staff. It is the responsibility of customer's technical departments to evaluate the suitability of the product for the intended application and the completeness of the product information given in this document with respect to such application.

For further information on the product, technology, delivery terms and conditions and prices please contact your nearest Infineon Technologies office (www.infineon.com).

WARNINGS

Due to technical requirements products may contain dangerous substances. For information on the types in question please contact your nearest Infineon Technologies office.

Except as otherwise explicitly approved by Infineon Technologies in a written document signed by authorized representatives of Infineon Technologies, Infineon Technologies' products may not be used in any applications where a failure of the product or any consequences of the use thereof can reasonably be expected to result in personal injury.