

Magneto-resistive Sensor ICs 2SS52M Series

005987

Issue 2

Datasheet

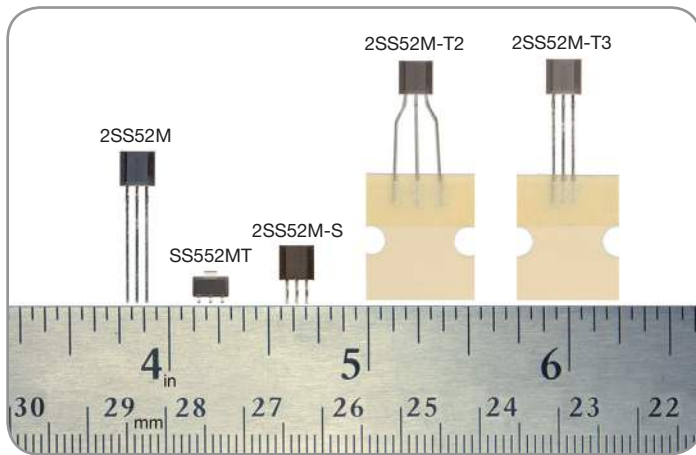

DESCRIPTION

The 2SS52M Series Digital Magneto-resistive Sensors are omnipolar, solid-state sensors with a built-in magneto-resistive bridge integrated on silicon and encapsulated in a plastic package. The integrated circuit also includes a band-gap regulator and a digital output in response to very low magnetic fields.

These sensor ICs may be operated with either a North or a South magnetic pole applied in parallel to the sensor IC. The polarity does not need to be identified, simplifying installation in single pole applications and doubling the resolution in rotating magnet applications.

These small and highly sensitive omnipolar devices have become a popular building block for flow metering, motor RPM and cylinder position sensing.

They are available in five package styles:

- **2SS52M:** U-pack, 3-pin, in-line sensor IC with straight leads supplied in bulk packaging (1000 units per bag)
- **SS552MT:** SOT-89B surface-mount sensor IC supplied on tape and reel which allows for compact design with automated component placement (1000 units per tape and reel)
- **2SS52M-S:** U-pack, 3-pin in-line, surface-mount sensor IC supplied in bulk packaging (1000 units per bag)
- **2SS52M-T2:** U-pack, 3-pin, in-line sensor IC with formed leads supplied in ammo pack tape-in-box (5000 units per box)
- **2SS52M-T3:** U-pack, 3-pin, in-line sensor IC with straight leads supplied in ammo pack tape-in-box (5000 units per box)

FEATURES

- High sensitivity: 25 Gauss maximum operate point allows for extended sensing distance or a smaller magnet
- 3.8 Vdc to 30 Vdc supply voltage range
- Omnipolar sensing: Activates with either North or South pole
- Temperature range: -40 °C to 150 °C [-40 °F to 302 °F]
- Digital current-sinking output
- RoHs compliant, meets Directive 2002/95/EC

POTENTIAL APPLICATIONS

Industrial

- High frequency flow sensing in HVAC, water, fuel meters, and gas utility meters
- Anti-tamper detection in water, electric, and gas utility meters
- Liquid level detection
- Motor RPM sensing
- In-cylinder position sensing

Medical

- RPM sensing in exercise and rehabilitation equipment
- Magnetic interrupt in exercise and rehabilitation equipment
- Absence/presence detection in infusion pumps
- Position sensing of medication dispensing cabinet drawers
- Incline position sensing in hospital beds

White goods

- Lid, door and drawer position detection
- Fluid flow detection
- Liquid level detection

PORTFOLIO

The 2SS52M Series is part of Honeywell's family of Digital Magneto-resistive Sensor ICs:

- SM351LT, SM353LT
- SM351RT, SM353RT, SM451R, SM453R

Magnetoresistive Sensor ICs

2SS52M Series

Table 1. Electrical and Environmental Specifications

(At $V_{\text{supply}} = 3.8 \text{ Vdc}$ to 30 Vdc , $T_A = -40 \text{ °C}$ to 150 °C [-40 °F to 302 °F] except where otherwise specified.)

Characteristic	Condition	Min.	Typ.	Max.	Unit
Supply voltage	no load	3.8	—	30	Vdc
Supply current:					
operated	24 °C ±2 °C, 16 Vdc ±0.5 % V_{supply}	—	6	11	mA
released	24 °C ±2 °C, 16 Vdc ±0.5 % V_{supply}	—	6	10	
Output leakage current (released)	—	—	—	10.0	μA
Output voltage (operated)	sinking, 20 mA max.	—	0.25	0.40	V
Output switching time:					
rise (10 % to 90 %)	1600 Ohm, 20 pF load	—	0.2	1.5	μs
fall (90 % to 10 %)	1600 Ohm, 20 pF load	—	0.1	1.5	
Operating temperature range	—	-40 [-40]	—	150 [302]	°C [°F]
Soldering temperature and time: SS552MT all other catalog listings	infrared reflow process: peak temperature 245 °C [473 °F] for 10 s max. wave soldering process: 250 °C to 260 °C [482 °F to 500 °F] for 3 s max.				

Table 2. Magnetic Characteristics (At $V_{\text{supply}} = 3.8 \text{ Vdc}$ to 30 Vdc .)

Temperature Range	Operate		Release	Differential	
	Minimum	Maximum	Minimum	Minimum	Maximum
-20 °C to 85 °C [-4 °F to 185 °F]	—	25 Gauss	5 Gauss	—	7 Gauss
-40 °C to 150 °C [-40 °F to 302 °F]	—	25 Gauss	4 Gauss	—	8 Gauss

Table 3. Absolute Maximum Specifications

Characteristic	Min.	Typ.	Max.	Unit
Supply voltage	-0.5	—	30	Vdc
Voltage externally applied to output:				
OFF condition only	—	—	30	Vdc
OFF or ON condition	-0.5	—	—	
Output current	—	—	20	mA
Storage temperature	-40 [-40]	—	150 [302]	°C [°F]
Magnetic flux	—	—	no limit	Gauss

NOTICE

Absolute maximum ratings are the extreme limits the device will withstand without damage to the device. Electrical and mechanical characteristics are not guaranteed as maximum limits (above recommended operating conditions) are approached, nor will the device necessarily operate at absolute maximum ratings.

	<p>CAUTION ELECTROSTATIC SENSITIVE DEVICES</p> <p>DO NOT OPEN OR HANDLE EXCEPT AT A STATIC FREE WORKSTATION</p>	
<p>ESD SENSITIVITY: CLASS 2</p>		

Magnetostrictive Sensor ICs

2SS52M Series

Figure 1. Block Diagram for Current Sinking Output (NPN)

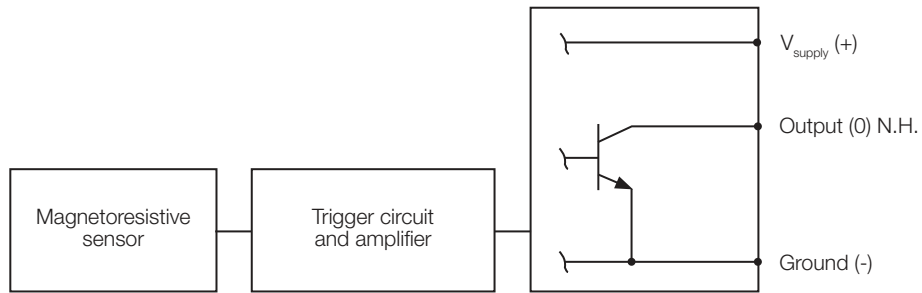
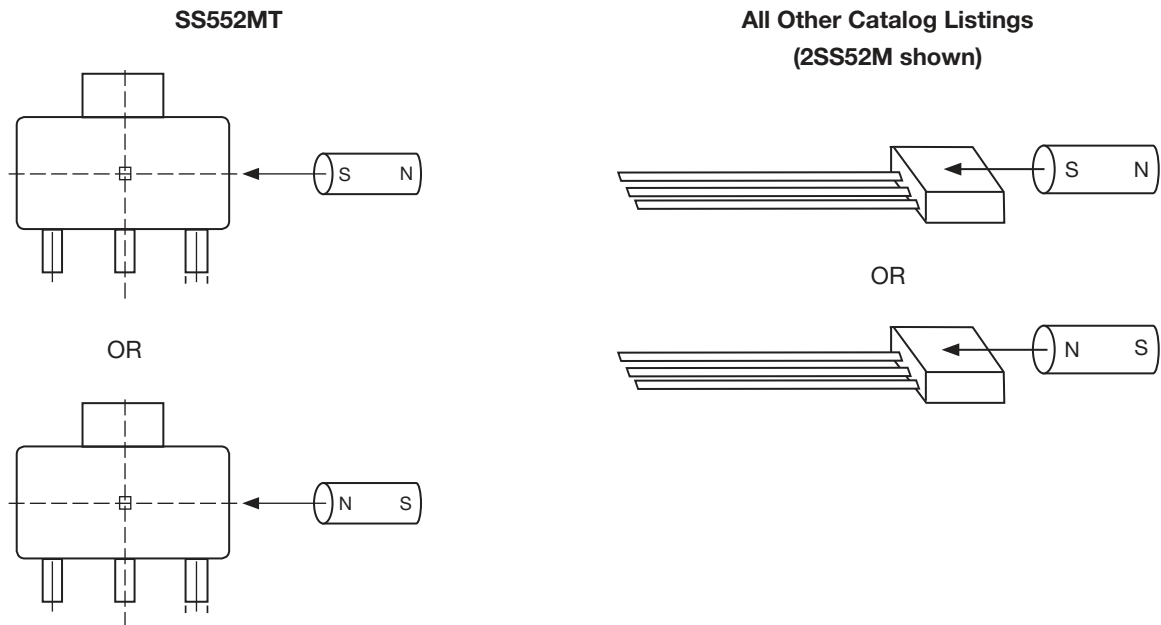

Figure 2. Magnet Alignment to the Sensor IC



- Operated by magnetic fields (North or South pole) that are parallel to the sensor IC; arrows indicate direction of magnetic flux.
- Due to the inherent high sensitivity of these sensor ICs, stray magnetic fields that are parallel to the sensor IC may affect operation.

Magnetoresistive Sensor ICs

2SS52M Series

Figure 3. Mounting Dimensions (For reference only. mm/in.)

2SS52M Sensor IC

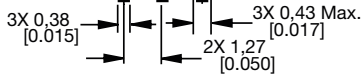
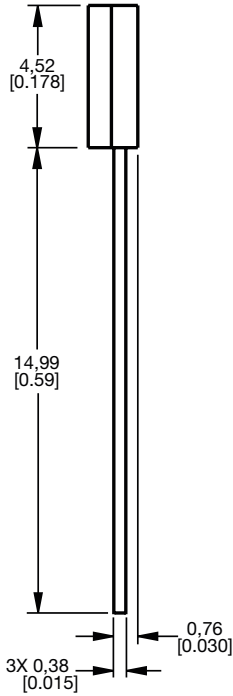
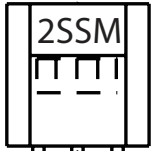
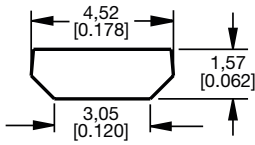

SS522MT Sensor IC

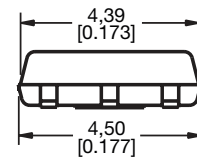
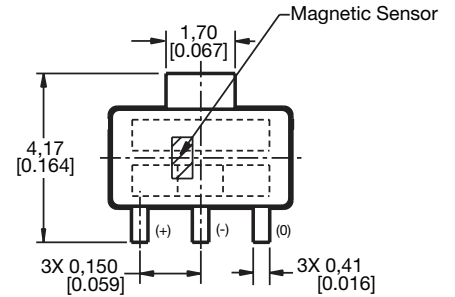
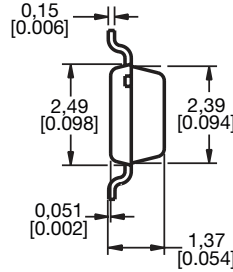

SS522MT Tape and Reel

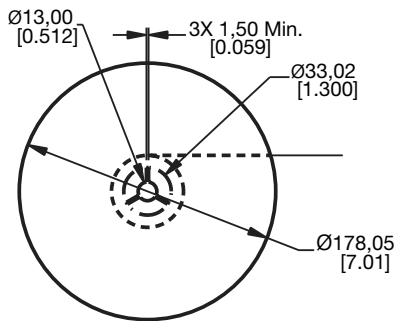
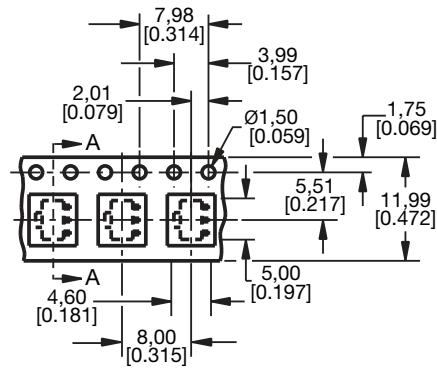
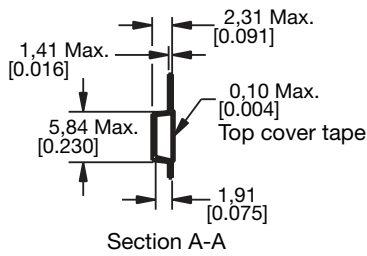

Direction of feed from reel

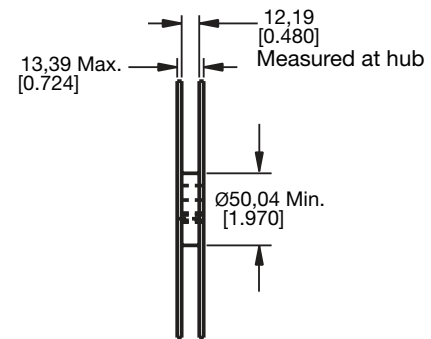

Magnetostrictive Sensor ICs

2SS52M Series

Figure 3. Mounting Dimensions (continued)

2SS52M-S Sensor IC

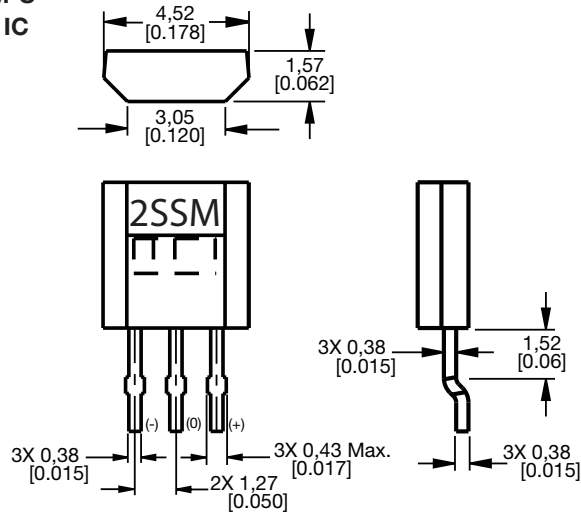

2SS52M-T2

Ammo pack tape-in-box

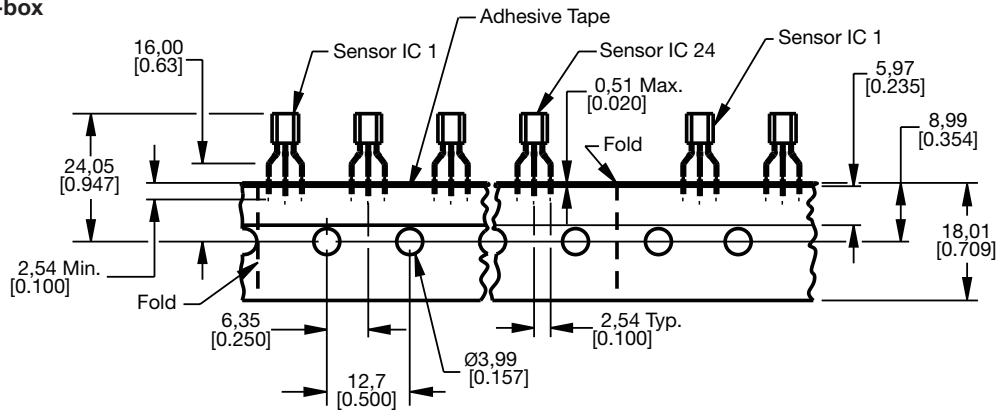

2SS52M-T3

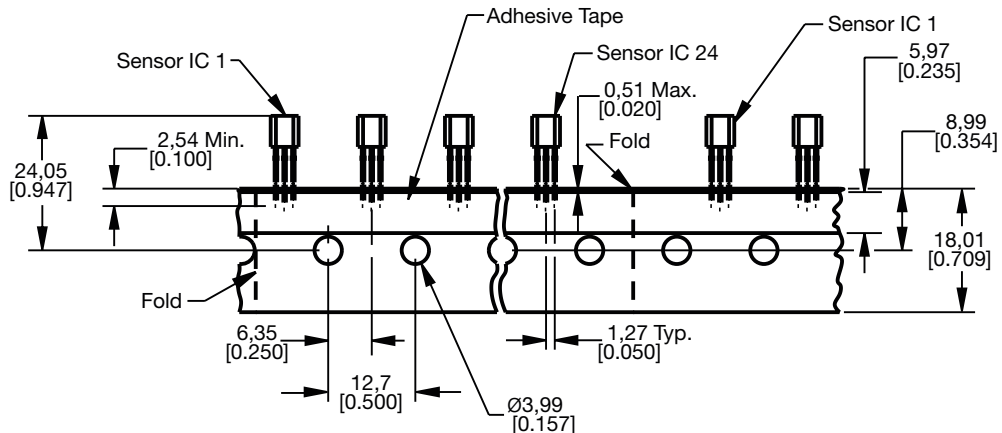

Ammo pack tape-in-box



Magneto-resistive Sensor ICs

2SS52M Series

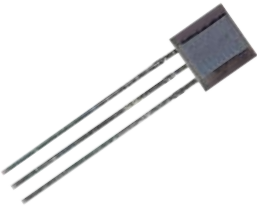
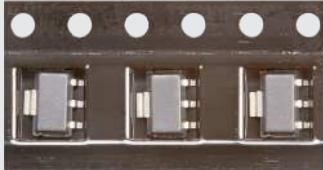
Table 4. Order Guide

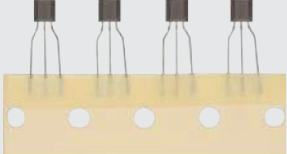
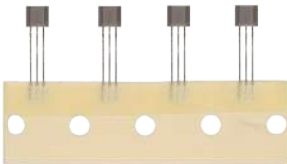
Catalog Listing	Description	
2SS52M	Magneto-resistive sensor IC, omnipolar, U-pack, straight leads 14,99 mm [0.590 in] long, bulk packaging (1000 units per bag)	
SS52MT	Magneto-resistive sensor IC, omnipolar, SOT-89B surface-mount package, tape and reel packaging (1000 units per reel)	
2SS52M-S	Magneto-resistive sensor IC, omnipolar, U-pack, surface-mount package, bulk packaging (1000 units per bag)	
2SS52M-T2	Magneto-resistive sensor IC, omnipolar, U-pack, formed leads 14,99 mm [0.590 in] long, ammo pack tape-in-box packaging (5000 units per box)	
2SS52M-T3	Magneto-resistive sensor IC, omnipolar, U-pack, straight leads 14,99 mm [0.590 in] long, ammo pack tape-in-box packaging (5000 units per box)	

ADDITIONAL MATERIALS

The following associated literature is available on the Honeywell website at sensing.honeywell.com:

- Product line guide
- Product range guide
- SS552MT installation instructions
- Magnetic sensor IC selection chart
- Application Notes:
 - Magnetoresistive sensors: Position and solid state sensor
 - Blood Recovery System
- Technical Notes:
 - Solid-State Sensors Glossary of Terms
 - Interpreting Operating Characteristics for Solid-State Sensors

Find out more

Honeywell serves its customers through a worldwide network of sales offices, representatives and distributors. For application assistance, current specifications, pricing or name of the nearest Authorized Distributor, contact your local sales office.

To learn more about Honeywell's sensing and switching products, call **+1-815-235-6847** or **1-800-537-6945**, visit sensing.honeywell.com, or e-mail inquiries to info.sc@honeywell.com

Honeywell Sensing and Productivity Solutions

9680 Old Bailes Road
Fort Mill, SC 29707
honeywell.com

WARNING **PERSONAL INJURY**

DO NOT USE these products as safety or emergency stop devices or in any other application where failure of the product could result in personal injury.

Failure to comply with these instructions could result in death or serious injury.

WARNING **MISUSE OF DOCUMENTATION**

- The information presented in this product sheet is for reference only. Do not use this document as a product installation guide.
- Complete installation, operation, and maintenance information is provided in the instructions supplied with each product.

Failure to comply with these instructions could result in death or serious injury.

Warranty/Remedy

Honeywell warrants goods of its manufacture as being free of defective materials and faulty workmanship. Honeywell's standard product warranty applies unless agreed to otherwise by Honeywell in writing; please refer to your order acknowledgement or consult your local sales office for specific warranty details. If warranted goods are returned to Honeywell during the period of coverage, Honeywell will repair or replace, at its option, without charge those items it finds defective. **The foregoing is buyer's sole remedy and is in lieu of all other warranties, expressed or implied, including those of merchantability and fitness for a particular purpose. In no event shall Honeywell be liable for consequential, special, or indirect damages.**

While we provide application assistance personally, through our literature and the Honeywell web site, it is up to the customer to determine the suitability of the product in the application.

Specifications may change without notice. The information we supply is believed to be accurate and reliable as of this printing. However, we assume no responsibility for its use.

Honeywell