

Low-Voltage CMOS Octal Transceiver/Registered Transceiver With Dual Enable

With 5 V-Tolerant Inputs and Outputs (3-State, Non-Inverting)

The MC74LCX652 is a high performance, non-inverting octal transceiver/registered transceiver operating from a 2.3 to 3.6 V supply. High impedance TTL compatible inputs significantly reduce current loading to input drivers while TTL compatible outputs offer improved switching noise performance. A V_I specification of 5.5 V allows MC74LCX652 inputs to be safely driven from 5 V devices. The MC74LCX652 is suitable for memory address driving and all TTL level bus oriented transceiver applications.

Data on the A or B bus will be clocked into the registers as the appropriate clock pin goes from a LOW-to-HIGH logic level. Two Output Enable pins (\overline{OEBA} , OEAB) are provided to control the transceiver outputs. In the transceiver mode, data present at the high impedance port may be stored in either the A or the B register or in both. The select controls (SBA, SAB) can multiplex stored and real-time (transparent mode) data. In the isolation mode (both outputs disabled), A data may be stored in the B register or B data may be stored in the A register. When in the real-time mode, it is possible to store data without using the internal registers by simultaneously enabling OEAB and \overline{OEBA} . In this configuration, each output reinforces its input (data retention is not guaranteed in this mode).

- Designed for 2.3 to 3.6 V V_{CC} Operation
- 5 V Tolerant – Interface Capability With 5 V TTL Logic
- Supports Live Insertion and Withdrawal
- I_{OFF} Specification Guarantees High Impedance When $V_{CC} = 0$ V
- LVTTTL Compatible
- LVC MOS Compatible
- 24 mA Balanced Output Sink and Source Capability
- Near Zero Static Supply Current in All Three Logic States (10 μ A) Substantially Reduces System Power Requirements
- Latchup Performance Exceeds 500 mA
- ESD Performance: Human Body Model >2000 V; Machine Model >200 V

MC74LCX652

LCX

**LOW-VOLTAGE CMOS
OCTAL TRANSCEIVER/
REGISTERED TRANSCEIVER
WITH DUAL ENABLE**

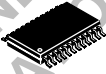

DT SUFFIX
24-LEAD PLASTIC TSSOP PACKAGE
CASE 948H

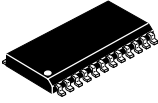

DW SUFFIX
24-LEAD PLASTIC SOIC PACKAGE
CASE 751E

Figure 1. PIN NAMES

Pins	Function
A0-A7	Side A Inputs/Outputs
B0-B7	Side B Inputs/Outputs
CAB, CBA	Clock Pulse Inputs
SAB, SBA	Select Control Inputs
OEBA, OEAB	Output Enable Inputs

MC74LCX652

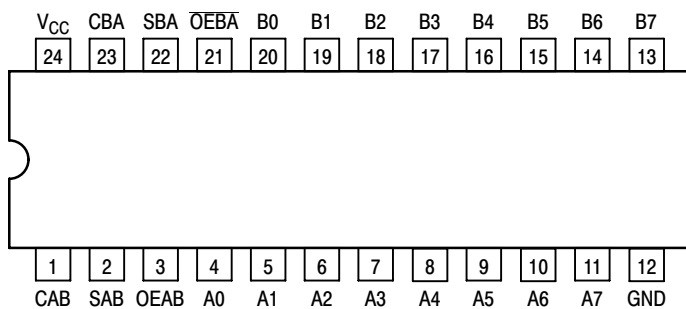

Figure 2. 24-Lead Pinout (Top View)

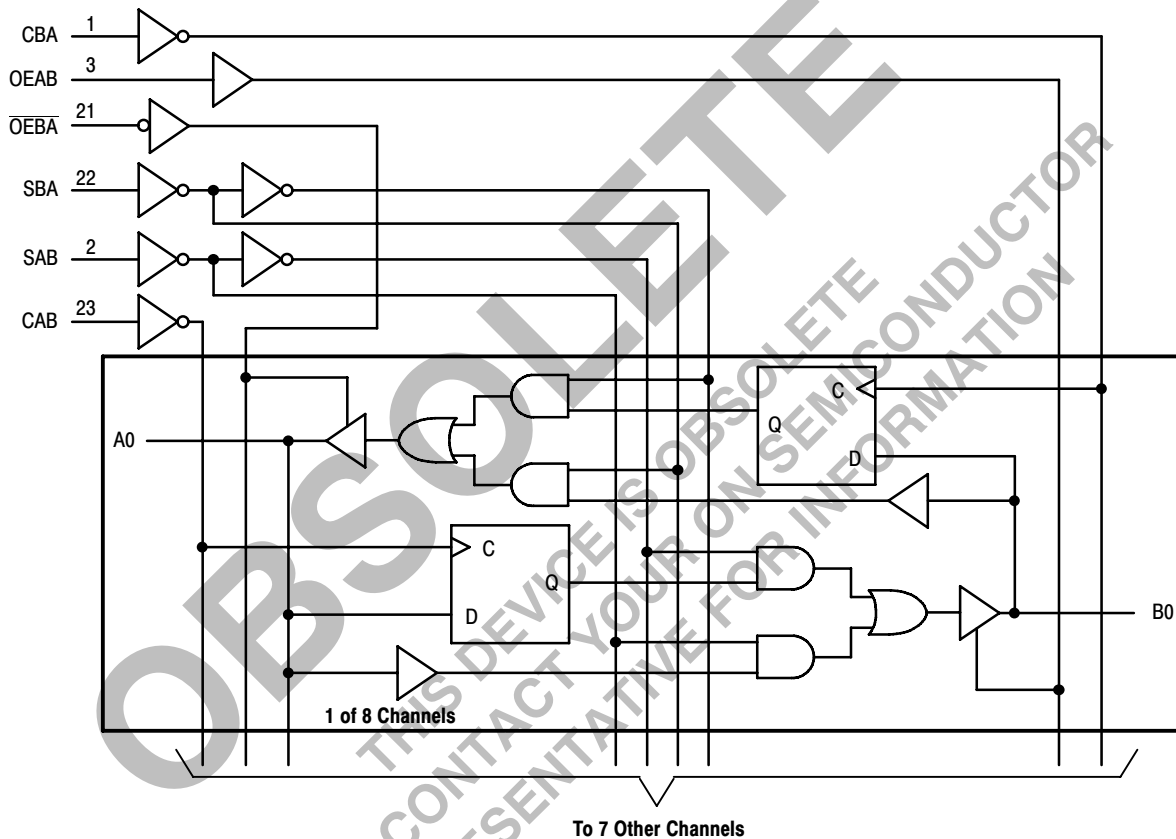

Figure 3. Logic Diagram

MC74LCX652

TRUTH TABLE

Inputs						Data Ports		Operating Mode
OEAB	OEBA	CAB	CBA	SAB	SBA	An	Bn	
L	H					Input	Input	
		↑	↑	X	X	X	X	Isolation, Hold Storage
		↑	↑	X	X	l h	l h	Store A and/or B Data
H	H					Input	Output	
		↑	X*	L	X	L H	L H	Real Time A Data to B Bus
				H	X	X	QA	Stored A Data to B Bus
		↑	X*	L	X	l h	L H	Real Time A Data to B Bus; Store A Data
				H	X	L H	QA QA	Clock A Data to B Bus; Store A Data
L	L					Output	Input	
		X*	↑	X	L	L H	L H	Real Time B Data to A Bus
				X	H	QB	X	Stored B Data to A Bus
		X*	↑	X	L	L H	l h	Real Time B Data to A Bus; Store B Data
				X	H	QB QB	L H	Clock B Data to A Bus; Store B Data
H	L					Output	Output	
		↑	↑	H	H	QB	QA	Stored A Data to B Bus, Stored B Data to A Bus

H = High Voltage Level

h = High Voltage Level One Setup Time Prior to the Low-to-High Clock Transition

L = Low Voltage Level

l = Low Voltage Level One Setup Time Prior to the Low-to-High Clock Transition

X = Don't Care

↑ = Low-to-High Clock Transition

↑ = NOT Low-to-High Clock Transition

QA = A input storage register

QB = B input storage register

* = The clocks are not internally gated with either the Output Enables or the Source Inputs. Therefore, data at the A or B ports may be clocked into the storage registers, at any time. For I_{CC} reasons, Do Not Float Inputs.

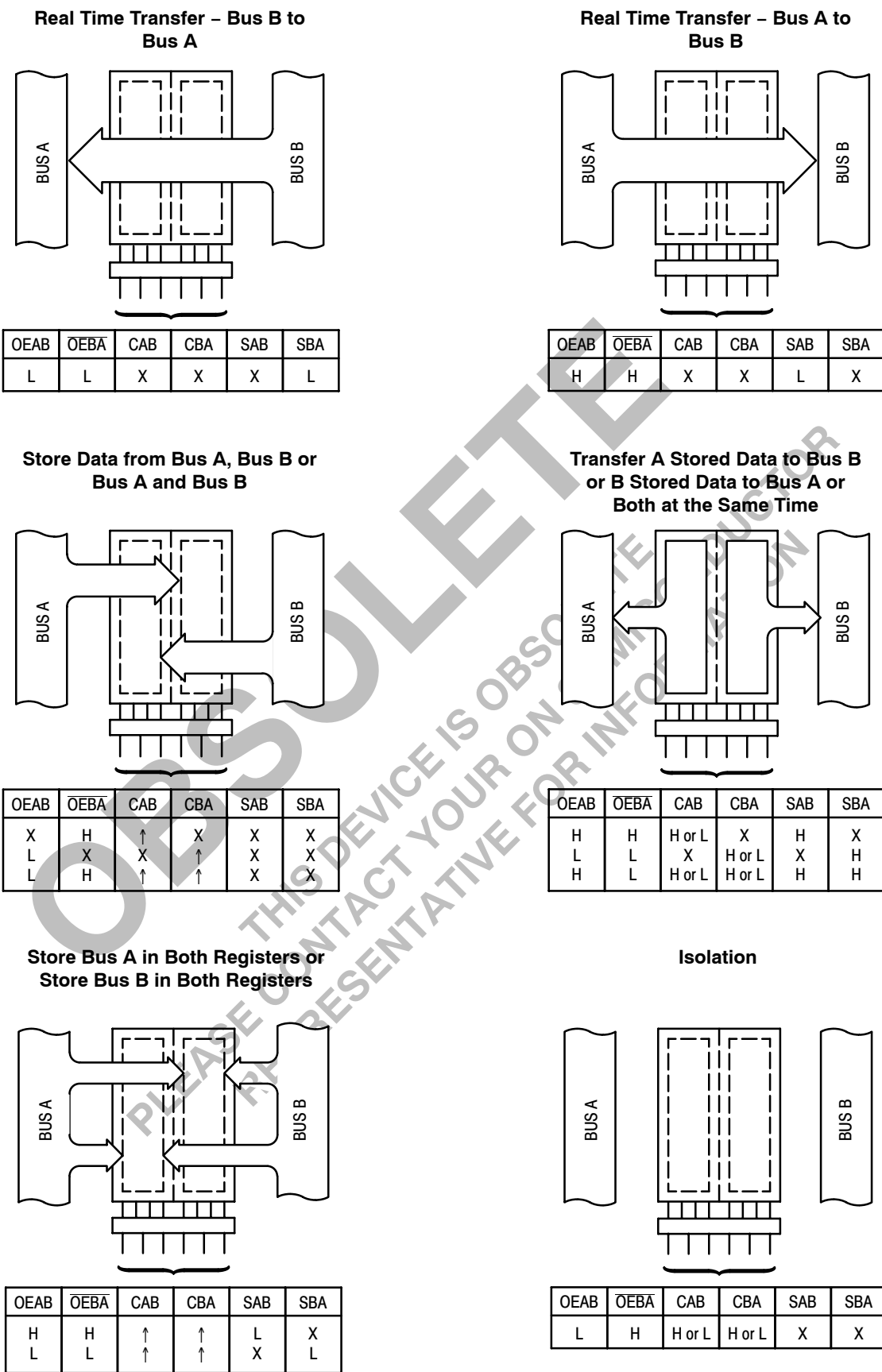

Figure 4. Bus Applications

MC74LCX652

MAXIMUM RATINGS

Symbol	Parameter	Value	Condition	Unit
V_{CC}	DC Supply Voltage	-0.5 to +7.0		V
V_I	DC Input Voltage	$-0.5 \leq V_I \leq +7.0$		V
V_O	DC Output Voltage	$-0.5 \leq V_O \leq +7.0$	Output in 3-State	V
		$-0.5 \leq V_O \leq V_{CC} + 0.5$	Note 1.	V
I_{IK}	DC Input Diode Current	-50	$V_I < GND$	mA
I_{OK}	DC Output Diode Current	-50	$V_O < GND$	mA
		+50	$V_O > V_{CC}$	mA
I_O	DC Output Source/Sink Current	± 50		mA
I_{CC}	DC Supply Current Per Supply Pin	± 100		mA
I_{GND}	DC Ground Current Per Ground Pin	± 100		mA
T_{STG}	Storage Temperature Range	-65 to +150		$^{\circ}C$

Stresses exceeding Maximum Ratings may damage the device. Maximum Ratings are stress ratings only. Functional operation above the Recommended Operating Conditions is not implied. Extended exposure to stresses above the Recommended Operating Conditions may affect device reliability.

1. Output in HIGH or LOW State. I_O absolute maximum rating must be observed.

RECOMMENDED OPERATING CONDITIONS

Symbol	Parameter	Min	Typ	Max	Unit	
V_{CC}	Supply Voltage	Operating	2.0	3.3	3.6	V
		Data Retention Only	1.5	3.3	3.6	
V_I	Input Voltage	0		5.5	V	
V_O	Output Voltage (HIGH or LOW State) (3-State)	0		V_{CC}	V	
		0		5.5		
I_{OH}	HIGH Level Output Current, $V_{CC} = 3.0\text{ V} - 3.6\text{ V}$			-24	mA	
I_{OL}	LOW Level Output Current, $V_{CC} = 3.0\text{ V} - 3.6\text{ V}$			24	mA	
I_{OH}	HIGH Level Output Current, $V_{CC} = 2.7\text{ V} - 3.0\text{ V}$			-12	mA	
I_{OL}	LOW Level Output Current, $V_{CC} = 2.7\text{ V} - 3.0\text{ V}$			12	mA	
T_A	Operating Free-Air Temperature	-40		+85	$^{\circ}C$	
$\Delta t/\Delta V$	Input Transition Rise or Fall Rate, V_{IN} from 0.8 V to 2.0 V, $V_{CC} = 3.0\text{ V}$	0		10	ns/V	

DC ELECTRICAL CHARACTERISTICS

Symbol	Characteristic	Condition	$T_A = -40^{\circ}C$ to $+85^{\circ}C$		Unit
			Min	Max	
V_{IH}	HIGH Level Input Voltage (Note 2.)	$2.7\text{ V} \leq V_{CC} \leq 3.6\text{ V}$	2.0		V
V_{IL}	LOW Level Input Voltage (Note 2.)	$2.7\text{ V} \leq V_{CC} \leq 3.6\text{ V}$		0.8	V
V_{OH}	HIGH Level Output Voltage	$2.7\text{ V} \leq V_{CC} \leq 3.6\text{ V}$; $I_{OH} = -100\ \mu A$	$V_{CC} - 0.2$		V
		$V_{CC} = 2.7\text{ V}$; $I_{OH} = -12\text{ mA}$	2.2		
		$V_{CC} = 3.0\text{ V}$; $I_{OH} = -18\text{ mA}$	2.4		
		$V_{CC} = 3.0\text{ V}$; $I_{OH} = -24\text{ mA}$	2.2		
V_{OL}	LOW Level Output Voltage	$2.7\text{ V} \leq V_{CC} \leq 3.6\text{ V}$; $I_{OL} = 100\ \mu A$		0.2	V
		$V_{CC} = 2.7\text{ V}$; $I_{OL} = 12\text{ mA}$		0.4	
		$V_{CC} = 3.0\text{ V}$; $I_{OL} = 16\text{ mA}$		0.4	
		$V_{CC} = 3.0\text{ V}$; $I_{OL} = 24\text{ mA}$		0.55	

2. These values of V_I are used to test DC electrical characteristics only.

MC74LCX652

DC ELECTRICAL CHARACTERISTICS (Continued)

Symbol	Characteristic	Condition	T _A = -40°C to +85°C		Unit
			Min	Max	
I _I	Input Leakage Current	2.7 V ≤ V _{CC} ≤ 3.6 V; 0 V ≤ V _I ≤ 5.5 V		±5.0	μA
I _{OZ}	3-State Output Current	2.7 ≤ V _{CC} ≤ 3.6 V; 0 V ≤ V _O ≤ 5.5 V; V _I = V _{IH} or V _{IL}		±5.0	μA
I _{OFF}	Power-Off Leakage Current	V _{CC} = 0 V; V _I or V _O = 5.5 V		10	μA
I _{CC}	Quiescent Supply Current	2.7 ≤ V _{CC} ≤ 3.6 V; V _I = GND or V _{CC}		10	μA
		2.7 ≤ V _{CC} ≤ 3.6 V; 3.6 ≤ V _I or V _O ≤ 5.5 V		±10	μA
ΔI _{CC}	Increase in I _{CC} per Input	2.7 ≤ V _{CC} ≤ 3.6 V; V _{IH} = V _{CC} - 0.6 V		500	μA

AC CHARACTERISTICS (t_R = t_F = 2.5 ns; C_L = 50 pF; R_L = 500 Ω)

Symbol	Parameter	Waveform	Limits				Unit
			T _A = -40°C to +85°C				
			V _{CC} = 3.0 V to 3.6 V		V _{CC} = 2.7 V		
			Min	Max	Min	Max	
f _{max}	Clock Pulse Frequency	3	150				MHz
t _{PLH} t _{PHL}	Propagation Delay Input to Output	1	1.5 7.0	7.0 1.5	1.5 8.0	8.0 1.5	ns
t _{PLH} t _{PHL}	Propagation Delay Clock to Output	3	1.5 8.5	8.5 1.5	1.5 9.5	9.5 1.5	ns
t _{PLH} t _{PHL}	Propagation Delay Select to Output	1	1.5 8.5	8.5 1.5	1.5 9.5	9.5 1.5	ns
t _{PZH} t _{PZL}	Output Enable Time to High and Low Level	2	1.5 8.5	8.5 1.5	1.5 9.5	9.5 1.5	ns
t _{PHZ} t _{PLZ}	Output Disable Time From High and Low Level	2	1.5 8.5	8.5 1.5	1.5 9.5	9.5 1.5	ns
t _s	Setup Time, HIGH or LOW Data to Clock	3	2.5		2.5		ns
t _h	Hold Time, HIGH or LOW Data to Clock	3	1.5		1.5		ns
t _w	Clock Pulse Width, HIGH or LOW	3	3.3		3.3		ns
t _{OSSL} t _{OSLH}	Output-to-Output Skew (Note 3.)			1.0 1.0			ns

3. Skew is defined as the absolute value of the difference between the actual propagation delay for any two separate outputs of the same device. The specification applies to any outputs switching in the same direction, either HIGH-to-LOW (t_{OSSL}) or LOW-to-HIGH (t_{OSLH}); parameter guaranteed by design.

DYNAMIC SWITCHING CHARACTERISTICS

Symbol	Condition	T _A = +25°C			Unit
		Min	Typ	Max	
V _{OLP}	V _{CC} = 3.3 V, C _L = 50 pF, V _{IH} = 3.3 V, V _{IL} = 0 V		0.8		V
V _{OLV}	V _{CC} = 3.3 V, C _L = 50 pF, V _{IH} = 3.3 V, V _{IL} = 0 V		0.8		V

4. Number of outputs defined as "n". Measured with "n-1" outputs switching from HIGH-to-LOW or LOW-to-HIGH. The remaining output is measured in the LOW state. The LCX652 is characterized with 7 outputs switching with 1 output held LOW.

MC74LCX652

CAPACITIVE CHARACTERISTICS

Symbol	Parameter	Condition	Typical	Unit
C_{IN}	Input Capacitance	$V_{CC} = 3.3\text{ V}$, $V_I = 0\text{ V}$ or V_{CC}	7	pF
$C_{I/O}$	Input/Output Capacitance	$V_{CC} = 3.3\text{ V}$, $V_I = 0\text{ V}$ or V_{CC}	8	pF
C_{PD}	Power Dissipation Capacitance	10 MHz, $V_{CC} = 3.3\text{ V}$, $V_I = 0\text{ V}$ or V_{CC}	25	pF

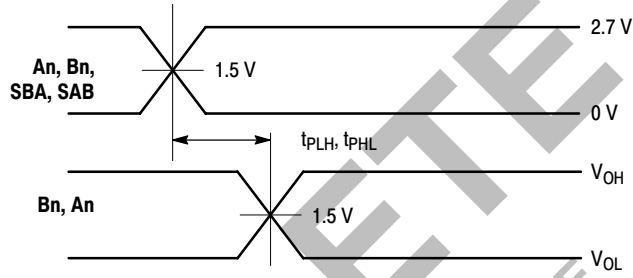

WAVEFORM 1 – SAB to B and SBA to A, An to Bn PROPAGATION DELAYS

$t_R = t_F = 2.5\text{ ns}$, 10% to 90%; $f = 1\text{ MHz}$; $t_W = 500\text{ ns}$

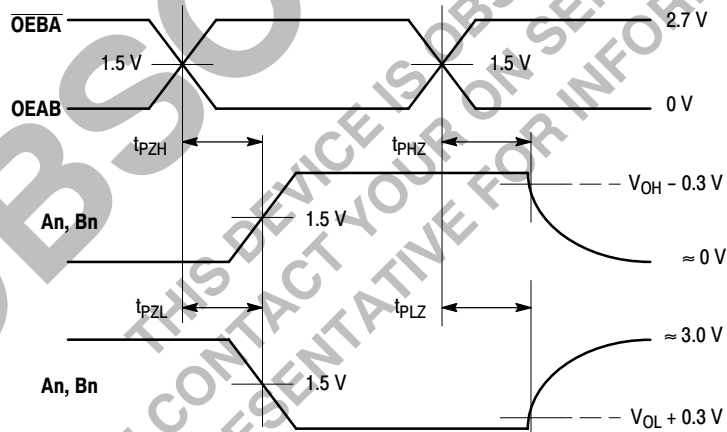

WAVEFORM 2 – OEBA/OEAB to An/Bn OUTPUT ENABLE AND DISABLE TIMES

$t_R = t_F = 2.5\text{ ns}$, 10% to 90%; $f = 1\text{ MHz}$; $t_W = 500\text{ ns}$

Figure 5. AC Waveforms

MC74LCX652

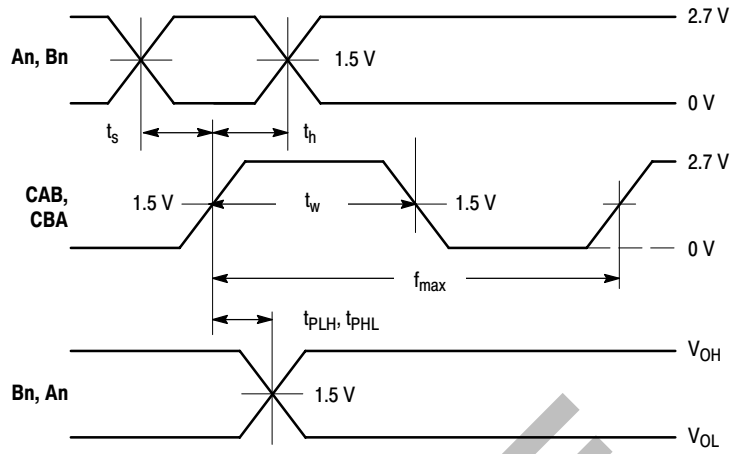

WAVEFORM 3 - CLOCK to Bn/An PROPAGATION DELAYS, CLOCK MINIMUM PULSE WIDTH, An/Bn to CLOCK SETUP AND HOLD TIMES

$t_R = t_F = 2.5$ ns, 10% to 90%; $f = 1$ MHz; $t_W = 500$ ns except when noted

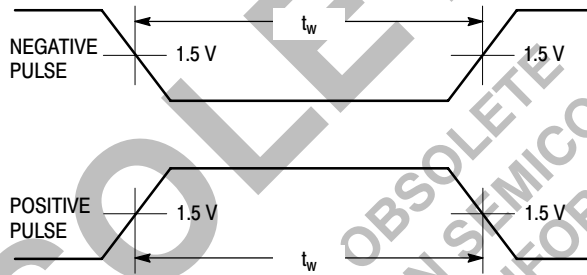

WAVEFORM 4 - INPUT PULSE DEFINITION

$t_R = t_F = 2.5$ ns, 10% to 90% of Q V to 2.7 V

Figure 5. AC Waveforms (Continued)

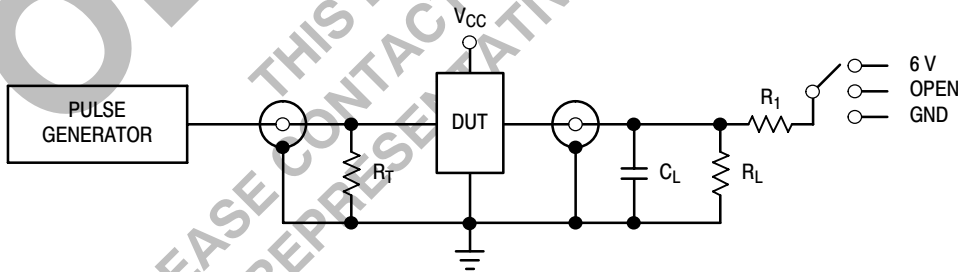

TEST	SWITCH
t_{PLH}, t_{PHL}	Open
t_{PZL}, t_{PLZ}	6 V
Open Collector/Drain t_{PLH} and t_{PHL}	6 V
t_{PZH}, t_{PHZ}	GND

$C_L = 50$ pF or equivalent (Includes jig and probe capacitance)

$R_L = R_1 = 500 \Omega$ or equivalent

$R_T = Z_{OUT}$ of pulse generator (typically 50Ω)

Figure 6. Test Circuit

MC74LCX652

PACKAGE DIMENSIONS

DT SUFFIX
 PLASTIC TSSOP PACKAGE
 CASE 948H-01
 ISSUE O

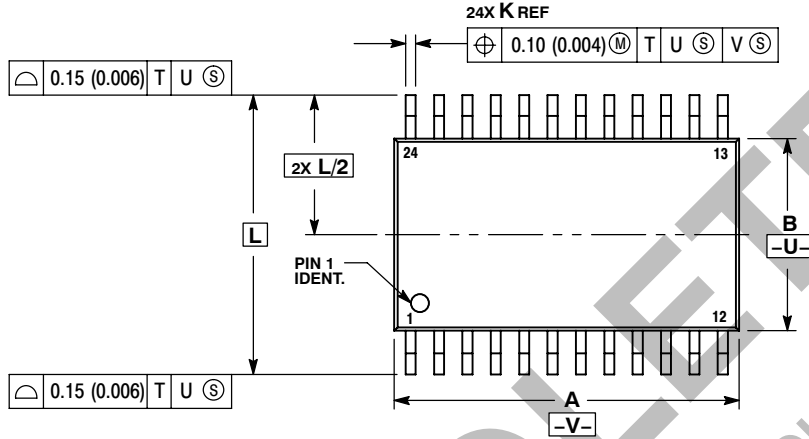

NOTES:

1. DIMENSIONING AND TOLERANCING PER ANSI Y14.5M, 1982.
2. CONTROLLING DIMENSION: MILLIMETER.
3. DIMENSION A DOES NOT INCLUDE MOLD FLASH, PROTRUSIONS OR GATE BURRS. MOLD FLASH OR GATE BURRS SHALL NOT EXCEED 0.15 (0.006) PER SIDE.
4. DIMENSION B DOES NOT INCLUDE INTERLEAD FLASH OR PROTRUSION. INTERLEAD FLASH OR PROTRUSION SHALL NOT EXCEED 0.25 (0.010) PER SIDE.
5. DIMENSION K DOES NOT INCLUDE DAMBAR PROTRUSION. ALLOWABLE DAMBAR PROTRUSION SHALL BE 0.08 (0.003) TOTAL IN EXCESS OF THE K DIMENSION AT MAXIMUM MATERIAL CONDITION.
6. TERMINAL NUMBERS ARE SHOWN FOR REFERENCE ONLY.
7. DIMENSION A AND B ARE TO BE DETERMINED AT DATUM PLANE -W-.



DIM	MILLIMETERS		INCHES	
	MIN	MAX	MIN	MAX
A	7.70	7.90	0.303	0.311
B	4.30	4.50	0.169	0.177
C	---	1.20	---	0.047
D	0.05	0.15	0.002	0.006
F	0.50	0.75	0.020	0.030
G	0.65 BSC		0.026 BSC	
H	0.27	0.37	0.011	0.015
J	0.09	0.20	0.004	0.008
J1	0.09	0.16	0.004	0.006
K	0.19	0.30	0.007	0.012
K1	0.19	0.25	0.007	0.010
L	6.40 BSC		0.252 BSC	
M	0°	8°	0°	8°

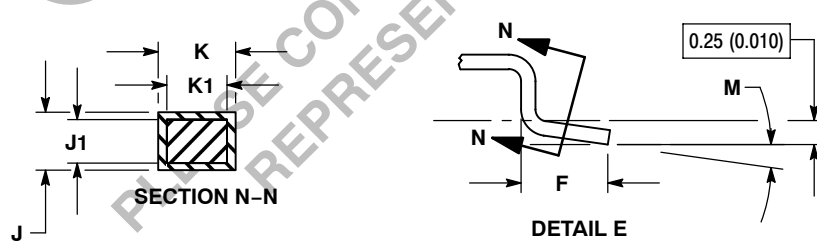
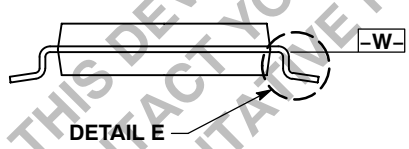

MC74LCX652

PACKAGE DIMENSIONS

DW SUFFIX
PLASTIC SOIC PACKAGE
CASE 751E-04
ISSUE E

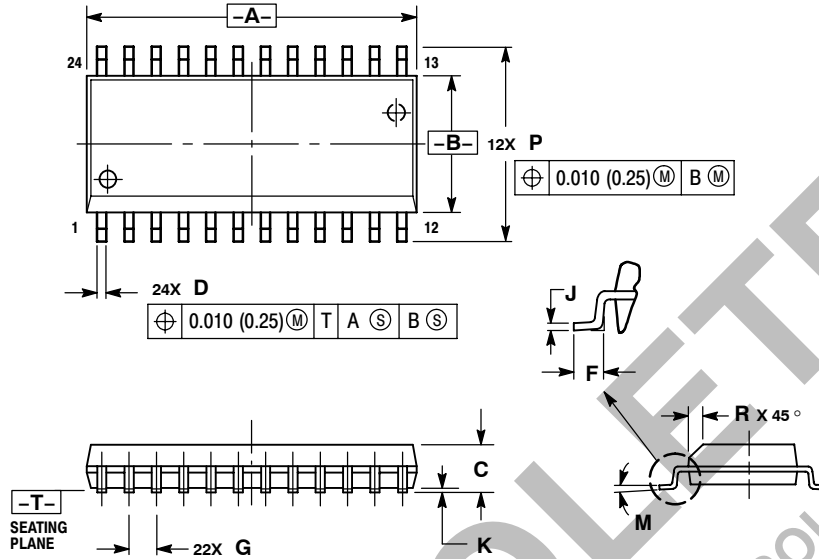

NOTES:

1. DIMENSIONING AND TOLERANCING PER ANSI Y14.5M, 1982.
2. CONTROLLING DIMENSION: MILLIMETER.
3. DIMENSIONS A AND B DO NOT INCLUDE MOLD PROTRUSION.
4. MAXIMUM MOLD PROTRUSION 0.15 (0.006) PER SIDE.
5. DIMENSION D DOES NOT INCLUDE DAMBAR PROTRUSION. ALLOWABLE DAMBAR PROTRUSION SHALL BE 0.13 (0.005) TOTAL IN EXCESS OF D DIMENSION AT MAXIMUM MATERIAL CONDITION.

MILLIMETERS		INCHES		
DIM	MIN	MAX	MIN	MAX
A	15.25	15.54	0.601	0.612
B	7.40	7.60	0.292	0.299
C	2.35	2.65	0.093	0.104
D	0.35	0.49	0.014	0.019
F	0.41	0.90	0.016	0.035
G	1.27 BSC		0.050 BSC	
J	0.23	0.32	0.009	0.013
K	0.13	0.29	0.005	0.011
M	0°	8°	0°	8°
P	10.05	10.55	0.395	0.415
R	0.25	0.75	0.010	0.029

ON Semiconductor and **ON** are registered trademarks of Semiconductor Components Industries, LLC (SCILLC). SCILLC reserves the right to make changes without further notice to any products herein. SCILLC makes no warranty, representation or guarantee regarding the suitability of its products for any particular purpose, nor does SCILLC assume any liability arising out of the application or use of any product or circuit, and specifically disclaims any and all liability, including without limitation special, consequential or incidental damages. "Typical" parameters which may be provided in SCILLC data sheets and/or specifications can and do vary in different applications and actual performance may vary over time. All operating parameters, including "Typicals" must be validated for each customer application by customer's technical experts. SCILLC does not convey any license under its patent rights nor the rights of others. SCILLC products are not designed, intended, or authorized for use as components in systems intended for surgical implant into the body, or other applications intended to support or sustain life, or for any other application in which the failure of the SCILLC product could create a situation where personal injury or death may occur. Should Buyer purchase or use SCILLC products for any such unintended or unauthorized application, Buyer shall indemnify and hold SCILLC and its officers, employees, subsidiaries, affiliates, and distributors harmless against all claims, costs, damages, and expenses, and reasonable attorney fees arising out of, directly or indirectly, any claim of personal injury or death associated with such unintended or unauthorized use, even if such claim alleges that SCILLC was negligent regarding the design or manufacture of the part. SCILLC is an Equal Opportunity/Affirmative Action Employer. This literature is subject to all applicable copyright laws and is not for resale in any manner.

PUBLICATION ORDERING INFORMATION

LITERATURE FULFILLMENT:
 Literature Distribution Center for ON Semiconductor
 P.O. Box 5163, Denver, Colorado 80217 USA
Phone: 303-675-2175 or 800-344-3860 Toll Free USA/Canada
Fax: 303-675-2176 or 800-344-3867 Toll Free USA/Canada
Email: orderlit@onsemi.com

N. American Technical Support: 800-282-9855 Toll Free
 USA/Canada
Europe, Middle East and Africa Technical Support:
 Phone: 421 33 790 2910
Japan Customer Focus Center
 Phone: 81-3-5773-3850

ON Semiconductor Website: www.onsemi.com
Order Literature: <http://www.onsemi.com/orderlit>

For additional information, please contact your local Sales Representative