

### 30 and 40 W - 10 Nm - Right-angle gearbox 801410 SNI10 Part number 80141003



#### With or without integrated control electronics

- Output perpendicular to motor
- Ideal for short reduction ratios
- Ideal for very compact applications
- Silent operation
- Non-reversible movement at high ratios

#### Part numbers

	Type	With built-in electronic control	Without built-in control, with Hall effect sensors	Ratios (i)	Output speed (rpm) 24 V DC	Available torque (Nm)	Efficiency (%)
<b>80141003</b>	801410 SNI10	SNI10	-	20	110	1,5	-

#### Specifications

##### General characteristics

Motor	80140004
Gearbox	81041
Nominal motor power at 24 V (W)	32
Max. torque (Nm)	10
Axial load dynamic (N)	10
Radial load dynamic (N)	15
Temperature rise at 50 % cycle (°C)	45
Weight (g)	1500
Protection index	IP54

#### Dimensions (mm)

##### 801410 with SNI10

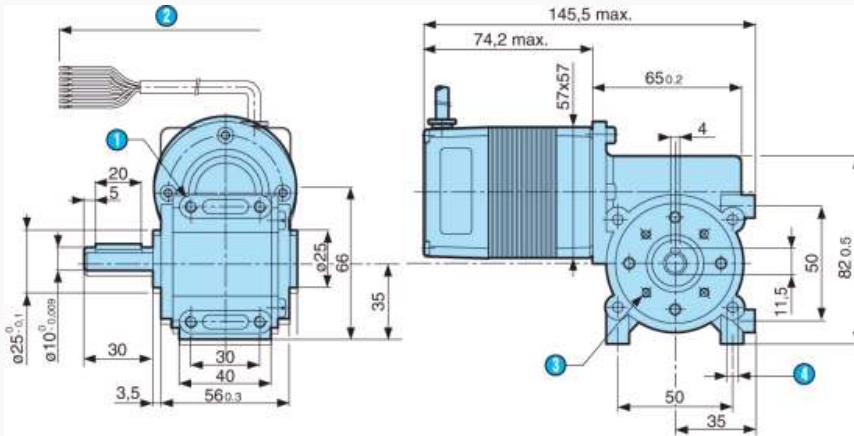

N°	Legend
1	4 x M5 depth 8 mm (on rectangle 30x50)
2	Length of cable 400 ± 10 mm
3	4 x M4 over Ø 36 depth 8 mm
4	4 x M5 over depth 8 mm (on rectangle 30x50) The left-hand and right-hand sides of the gearbox are identical

#### Precautions for use

The limits and precautions for use described in the 80140 brushless motor section must be observed.

#### Product adaptations



- Other powers (60 W - 95 W)
- Dimensions of gearbox shaft
- Without cable but with connector integrated in motor
- Cable length, with or without connector
- Other reduction ratios
- Mechanical holding brake