



[www.aopled.com](http://www.aopled.com)

**American Opto Plus LED Corp.**  
**0.56" SMD Type LED Display**  
**SMA561B-ST-1.5 G/W**  
**SMC561B-ST-1.5 G/W**

● **EDIT HISTORY**

Version A: Jul. 15, 2015

Preliminary spec.

Version B: Jul. 22, 2015

1. Modify mechanical dimensions.
2. Modify typical internal equivalent circuit.

Version C: Oct. 07, 2016

Add package spec.

Version D: Aug. 29, 2017

Modify package spec.

Version E: Apr. 25, 2019

1. Modify absolute maximum rating.
2. Modify electrical-optical characteristics.
3. Modify bin grade data.
4. Modify mechanical dimensions.
5. Modify curve graph.
6. Modify packing & label specifications.



[www.aopled.com](http://www.aopled.com)

**American Opto Plus LED Corp.**  
**0.56" SMD Type LED Display**  
**SMA561B-ST-1.5 G/W**  
**SMC561B-ST-1.5 G/W**

● **FEATURES**

- 0.56 inch (14.22 mm) Digit Height.
- Low current operation.
- Super thin SMD type.
- Gray face, White segment.
- RoHS compliant, Pb Free.

● **DESCRIPTION**

The SMA561B-ST-1.5 G/W & SMC561B-ST-1.5 G/W

Are 0.56 inch (14.22mm) height single digit 7-segment display.

This device utilizes Super Bright Blue LED chip which are made from InGaN on a transparent GaN, substrate.

The display has Gray face, White segment.

● **DEVICE**

PART NO	DESCRIPTION
SMA561B-ST-1.5 G/W	Common Anode
SMC561B-ST-1.5 G/W	Common Cathode

**RoHS Compliance**



**Pb free.**





[www.aopled.com](http://www.aopled.com)

# American Opto Plus LED Corp.

## 0.56" SMD Type LED Display

### SMA561B-ST-1.5 G/W

### SMC561B-ST-1.5 G/W

#### ● MECHANICAL DIMENSIONS

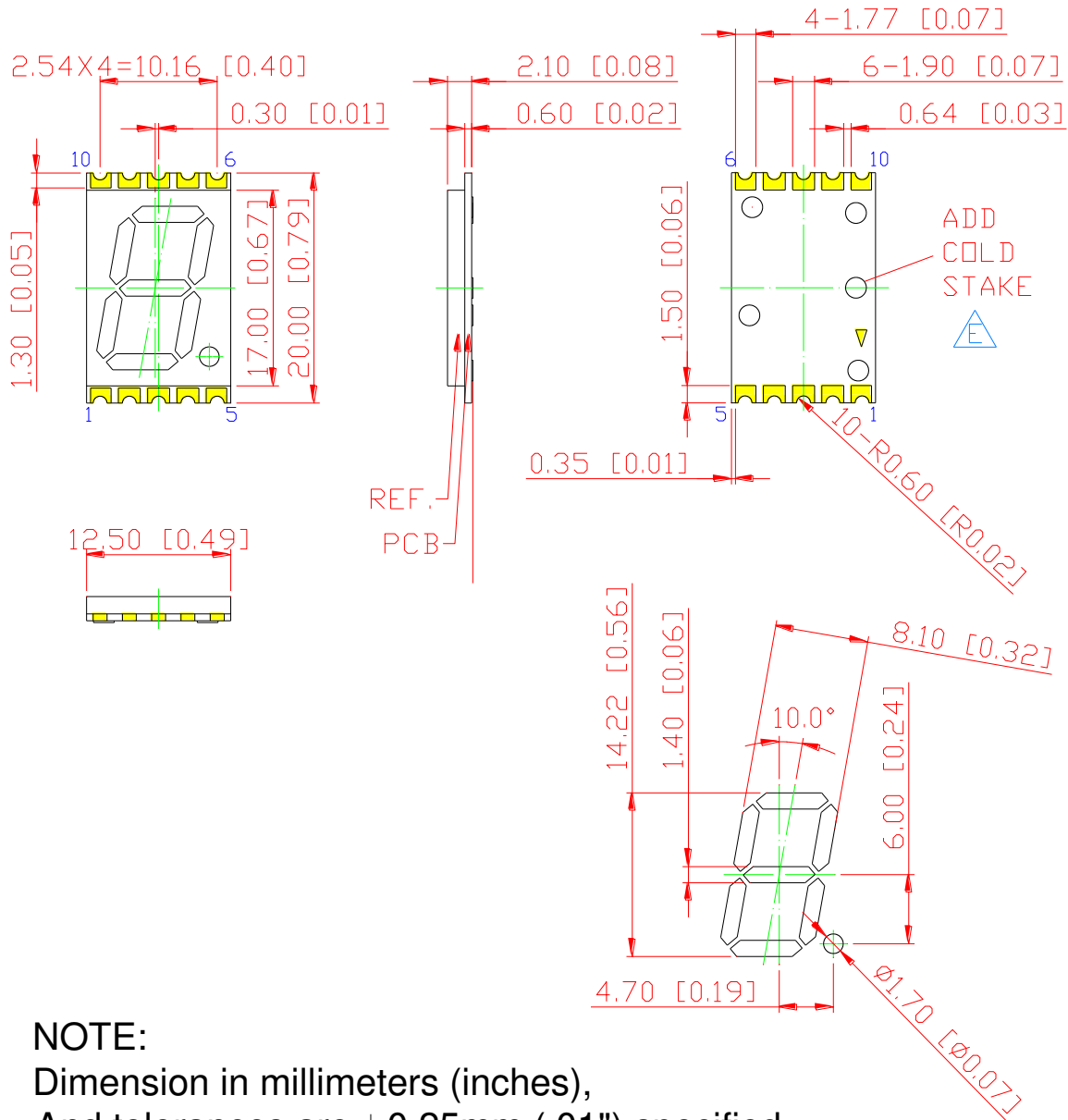

**NOTE:**  
Dimension in millimeters (inches),  
And tolerances are  $\pm 0.25\text{mm}$  (.01") specified.



[www.aopled.com](http://www.aopled.com)

# American Opto Plus LED Corp.

## 0.56" SMD Type LED Display

### SMA561B-ST-1.5 G/W

### SMC561B-ST-1.5 G/W

#### ● TYPICAL INTERNAL EQUIVALENT CIRCUIT

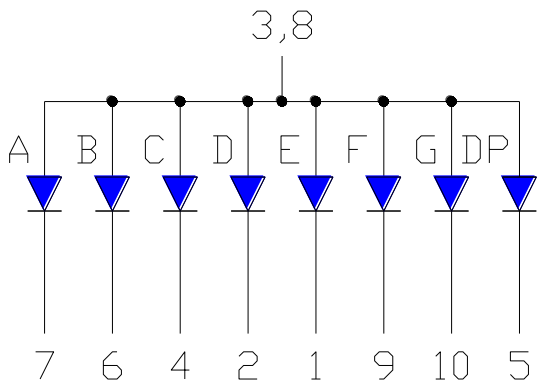
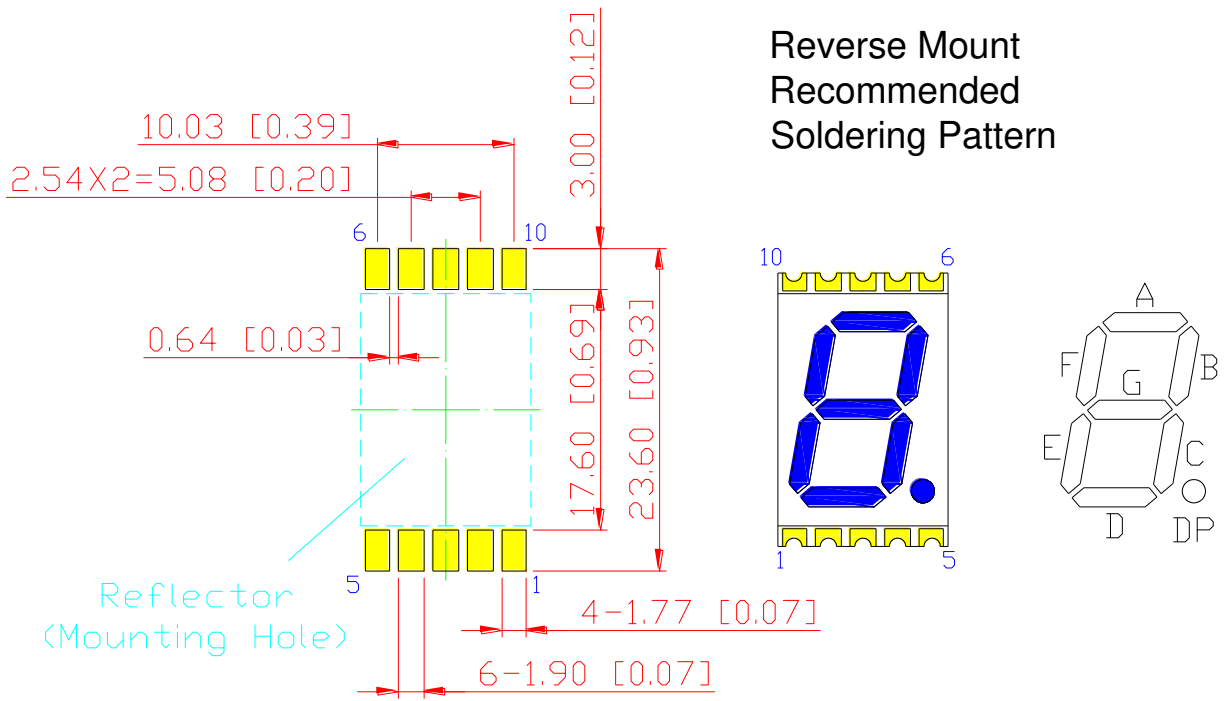

SMA561B-ST-1.5 G/W  
(Common Anode)

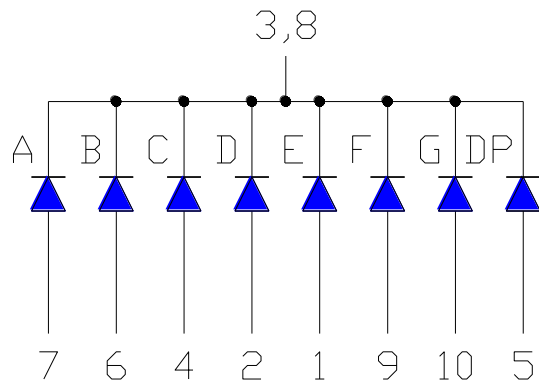

SMC561B-ST-1.5 G/W  
(Common Cathode)



[www.aopled.com](http://www.aopled.com)

**American Opto Plus LED Corp.**  
**0.56" SMD Type LED Display**  
**SMA561B-ST-1.5 G/W**  
**SMC561B-ST-1.5 G/W**

● **B: SUPER BRIGHT BLUE (InGaN/GaN)**

ABSOLUTE MAXIMUM RATING AT  $T_a=25^{\circ}\text{C}$

Parameter	Symbol	Maximum Rating	Unit
Power dissipation	$P_{AD}$	66	mW
Continuous forward current	$I_{AF}$	20	mA
Peak current (duty cycle 1/10, 1kHz)	$I_{PF}$	60	mA
Reverse voltage	$V_R$	5	V
Operating temperature	$T_{OPR}$	-40 to +85	$^{\circ}\text{C}$
Storage temperature	$T_{STG}$	-40 to +85	$^{\circ}\text{C}$

ELECTRICAL - OPTICAL CHARACTERISTICS AT  $T_a=25^{\circ}\text{C}$

Characteristic	Symbol	Condition	Min.	Type.	Max.	Unit
Forward Voltage, (Per Dice)	$V_F$	$I_F=5\text{mA}$	-	3.0	3.3	V
Reverse Current, (Per Dice)	$I_R$	$V_R=5\text{V}$	-	-	10	$\mu\text{A}$
Dominant Wavelength	$\lambda_D$	$I_F=5\text{mA}$	460	-	470	nm
Luminous Intensity	$I_V$	$I_F=5\text{mA}$	10	-	40	mcd
Spectral Line Half-Bandwidth	$\Delta\lambda$	$I_F=5\text{mA}$	-	20	-	nm



[www.aopled.com](http://www.aopled.com)

**American Opto Plus LED Corp.**  
**0.56" SMD Type LED Display**  
**SMA561B-ST-1.5 G/W**  
**SMC561B-ST-1.5 G/W**

● **B: BIN GRADE (Unit : mcd) 5mA**

Super Bright Blue	G	H	I
	10.0 – 20.0	20.1 – 30.0	30.1 – 40.0

● **B: HUE GRADE ( $\lambda_D$  : nm)**

Super Bright Blue	1	2	3
	460.0 - 463.0	463.1 – 467.0	467.1 – 470.0

● **AVAILABLE BIN / HUE TABLE**

G1	G2	G3
H1	H2	H3
I1	I2	I3



[www.aopled.com](http://www.aopled.com)

# American Opto Plus LED Corp.

## 0.56" SMD Type LED Display

### SMA561B-ST-1.5 G/W

### SMC561B-ST-1.5 G/W

## ● B: SUPER BRIGHT BLUE (InGaN/GaN) CURVE

Typical Electro-optical Characteristic Curves  
(25 °C Free Air Temperature Unless Otherwise Specified)

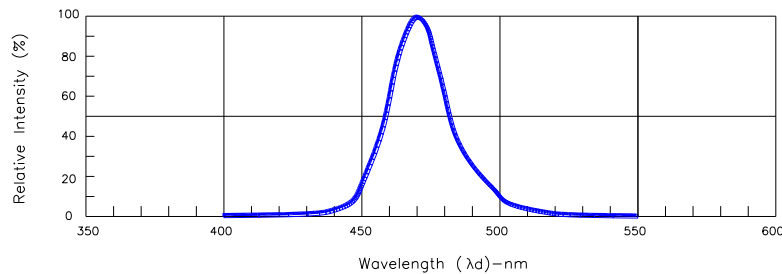

Fig.1-Relative Intensity VS. Wavelength

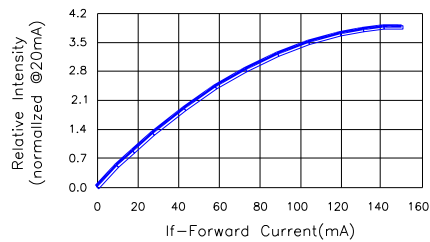

Fig.2-Relative Luminous Intensity vs. Forward Current

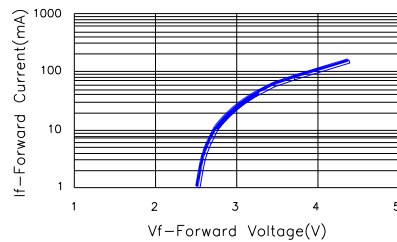

Fig.3-Forward Current vs. Forward Voltage

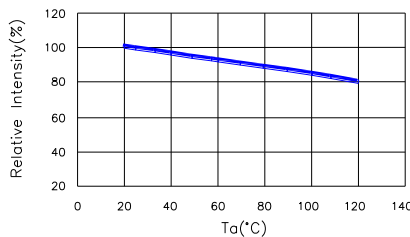

Fig.4-Relative Intensity(@20mA)VS. Ambient Temperature

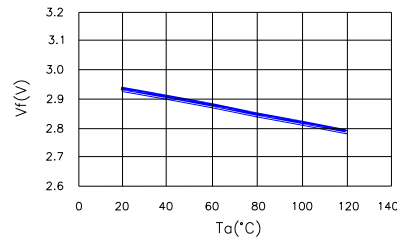

Fig.5-Forward Voltage(@20mA)VS. Ambient Temperature

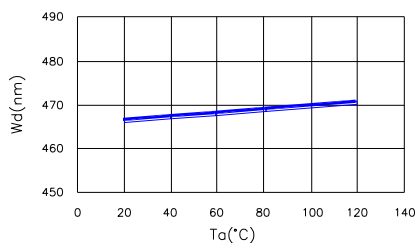

Fig.6-Dominant Wavelength(@20mA)  
VS. Ambient Temperature

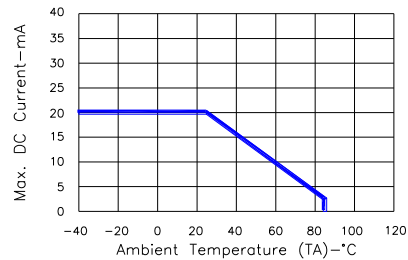

Fig.7-Max. Allowable DC Current  
VS. Ambient Temperature



[www.aopled.com](http://www.aopled.com)

# American Opto Plus LED Corp.

## 0.56" SMD Type LED Display

### SMA561B-ST-1.5 G/W

### SMC561B-ST-1.5 G/W

## ● SMT REFLOW SOLDERING INSTRUCTIONS

SMT Soldering Profile

Pb free reflow soldering Profile

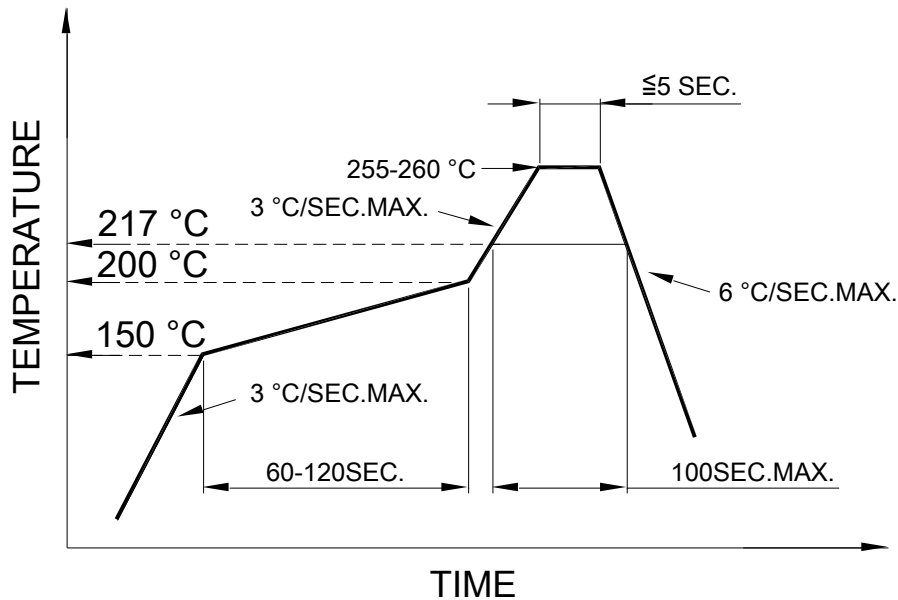

- We recommend the reflow temperature 245°C (+/- 5°C).  
The maximum soldering temperature should be limited to 260°C.
- Number of reflow process shall be 2 times or less.

## ● SOLDERING IRON

Basic spec is  $\leq 4$  sec when 260°C. If temperature is higher, time should be shorter (+10°C → 1 sec). Power dissipation of Iron should be smaller Than 15W, and temperature should be controllable. Surface temperature Of the device should be under 230°C.

## ● REWORK

- Customer must finish rework within 3 sec. under 350°C.
- The head of soldering iron cannot touch copper foil.





[www.aopled.com](http://www.aopled.com)

# American Opto Plus LED Corp.

## 0.56" SMD Type LED Display

### SMA561B-ST-1.5 G/W

### SMC561B-ST-1.5 G/W

#### ● REEL DIMENSIONS

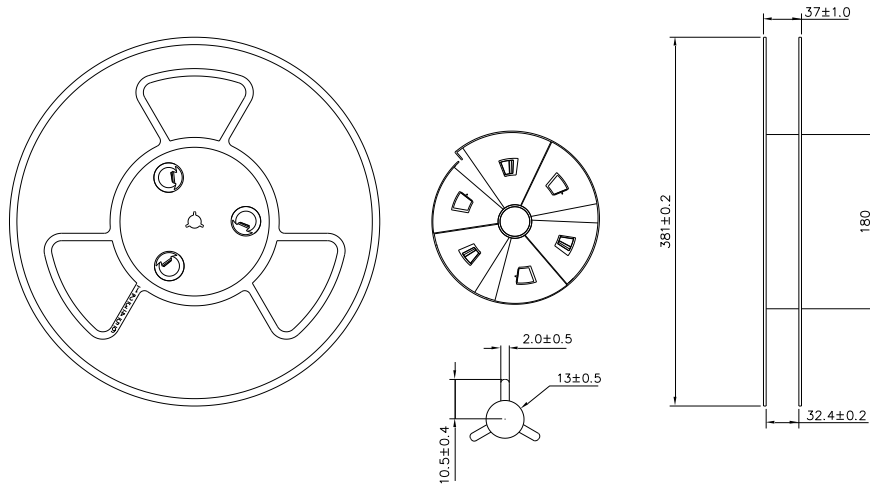

#### ● PACKING & LABEL SPECIFICATIONS

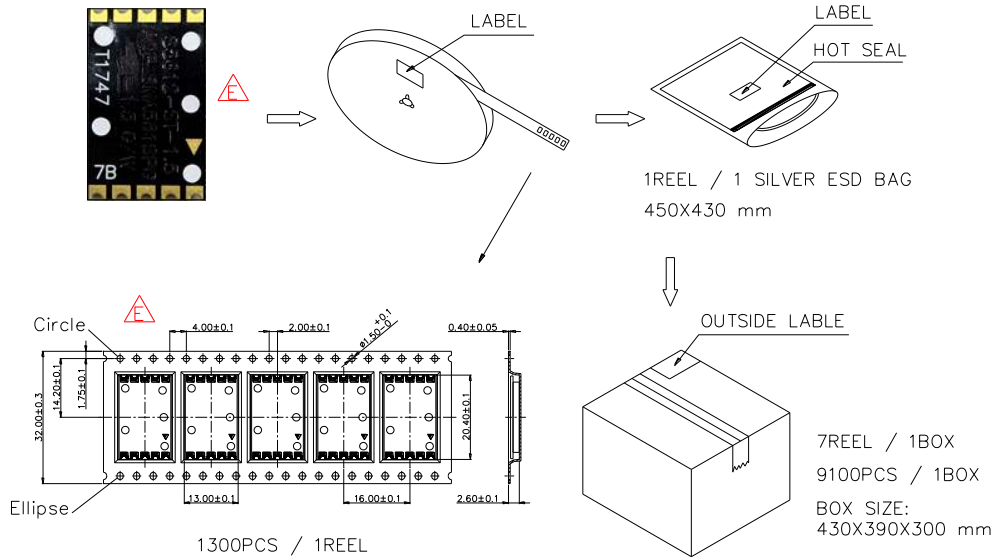

The leader and trailer length of actual tape with no component in it are 400 mm each.

#### ● STORAGE CONDITION

In factory original sealed bag package

TEMPERATURE CONDITION	HUMIDITY CONDITION
5°C ~ 30°C	Below 60%RH

After opened and not in factory original sealed bag package

TEMPERATURE CONDITION	HUMIDITY CONDITION	STORAGE TIME
5°C ~ 30°C	Below 60%RH	Within 4 weeks (MSL as level 2a)