

SCRs

JAN & JANTX 2N3027-2N3032

0.5 Amp, Planar



FEATURES

- JAN and JANTX Types Available
- Fully Characterized for "Worst Case" Design
- Passivated Planar Construction for Maximum Reliability and Parameter Uniformity
- Low On-State Voltage and Fast Switching at High Current Levels
- Typical Turn-On Time: 0.12μs
- Typical Recovery Time: 0.1μs
- Pulse Currents: to 30A

DESCRIPTION

The 2N3027 series of planar SCRs (controlled switches) are intended for use in military and space applications requiring a high degree of reliability. They offer a unique combination of extremely fast switching, precise triggering, high pulse power, small size, intrinsic parameter stability, and high radiation tolerance.

The JAN and JANTX types are specified under MIL-S-19500/419, and are included in MIL-STD-701 as recommended types for military usage.

ABSOLUTE MAXIMUM RATINGS

	JAN & JANTX 2N3027 JAN & JANTX 2N3030	JAN & JANTX 2N3028 JAN & JANTX 2N3031	JAN & JANTX 2N3029 JAN & JANTX 2N3032
Repetitive Peak Off-State Voltage, V_{DRM}	30V	60V	100V
Repetitive Peak Reverse Voltage, V_{RRM}	30V	60V	100V
D.C. On-State Current, I_T			
100°C Case		500mA	
75°C Ambient		250mA	
Repetitive Peak On-State Current, I_{IKM}		30A	
Surge (Non-Rep.) On-State Current, I_{TSM}			
50ms		5A	
8ms		8A	
Peak Gate Current, I_{GM}		250mA	
Average Gate Current, $I_{G(AV)}$		25mA	
Reverse Gate Voltage		5V	
Reverse Gate Current		3mA	
Storage Temperature Range		-65°C to +200°C	
Operating Temperature Range		-65°C to +150°C	

Note: Blocking voltage ratings apply over the operating temperature range, provided the gate is connected to the cathode through an appropriate resistor, or adequate gate bias is used. (See section on bias stabilization.)

MECHANICAL SPECIFICATIONS

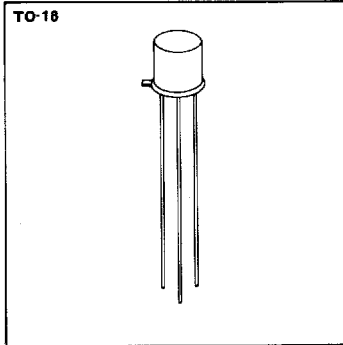
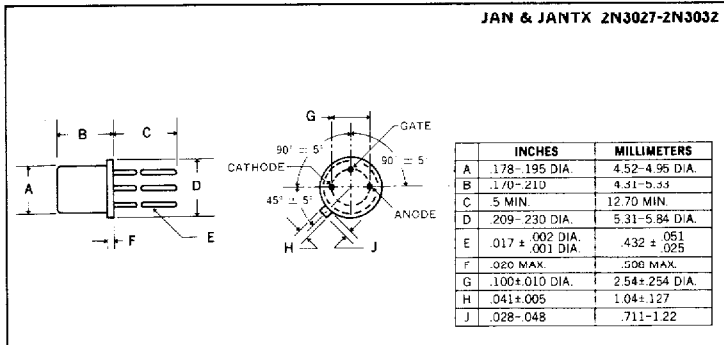

Microsemi Corp.
Watertown
The diode experts

ELECTRICAL SPECIFICATIONS (at 25°C unless noted) 2N3027 — 2N3028 — 2N3029

Parameter	Symbol	Min.	Typical	Max.	Units	Test Conditions
SUBGROUP 1 Visual and Mechanical						MIL-STD-750 Method 2071
SUBGROUP 2 (25°C Tests)						
Off-State Current	I_{DRM}	—	.002	0.1	μA	$R_{GK} = 1K, V_{DRM} = \text{Rating}$
Reverse Current	I_{RRM}	—	.002	0.1	μA	$R_{GK} = 1K, V_{RRM} = \text{Rating}$
Reverse Gate Voltage	V_{GR}	5	8	—	V	$I_{GR} = 0.1mA$
Gate Trigger Current	I_{GT}	-5	8	200	μA	$R_{GS} = 10K, V_D = 5V$
Gate Trigger Voltage	V_{GT}	.40	.55	.80	V	$R_{GS} = 100\Omega, V_D = 5V$
On-State Voltage	V_T	0.8	1.2	1.5	V	$I_T = 1A$ (pulse test)
Holding Current	I_H	0.3	0.7	5.0	mA	$R_{GK} = 1K, V_D = 5V$
SUBGROUP 3 (25°C Tests)						
Off-State Voltage — Critical Rate of Rise	dv_c/dt	30 15	60 30	—	$V/\mu s$	$R_{GK} = 1K, V_D = 30V$ (2N3027) $R_{GK} = 1K, V_D = 60V$ (2N3028)
Gate Trigger-on Pulse Width	$t_{pg}(\text{on})$	10	25	—	μs	$R_{GK} = 1K, V_D = 100V$ (2N3029)
Delay Time	t_d	—	.07	0.2	μs	$I_G = 10mA, I_T = 1A, V_D = 30V$
Rise Time	t_r	—	.08	—	μs	$I_G = 10mA, I_T = 1A, V_D = 30V$
Circuit Commutated Turn-off Time	t_g	—	.04	—	μs	$I_G = 10mA, I_T = 1A, V_D = 30V$
SUBGROUP 4 (150°C Tests)						
High Temp. Off-State Current	I_{DRM}	—	2	20	μA	$R_{GK} = 1K, V_{DRM} = \text{Rating}$
High Temp. Reverse Current	I_{RRM}	—	20	50	μA	$R_{GK} = 1K, V_{RRM} = \text{Rating}$
High Temp. Gate Trigger Voltage	V_{GT}	.10	.15	0.6	V	$R_{GS} = 100\Omega, V_D = 5V$
High Temp. Holding Current	I_H	.05	.20	1.0	mA	$R_{GK} = 1K, V_D = 5V$
SUBGROUP 5 (-65°C Tests)						
Low Temp. Gate Trigger Voltage	V_{GT}	0.6	0.75	1.1	V	$R_{GS} = 100\Omega, V_D = 5V$
Low Temp. Gate Trigger Current	I_{GT}	0	150	1.2	mA	$R_{GS} = 10K, V_D = 5V$
Low Temp. Holding Current	I_H	0.5	3.5	10	mA	$R_{GK} = 1K, V_D = 5V$



ELECTRICAL SPECIFICATIONS (at 25°C unless noted) 2N3030 — 2N3031 — 2N3032

Parameter	Symbol	Min.	Typical	Max.	Units	Test Conditions
SUBGROUP 1 Visual and Mechanical						MIL-STD-750 Method 2071
SUBGROUP 2 (25°C Tests)						
Off-State Current	I_{DRM}	—	.002	0.1	μA	$R_{GK} = 1K, V_{DRM} = \text{Rating}$
Reverse Current	I_{RRM}	—	.002	0.1	μA	$R_{GK} = 1K, V_{RRM} = \text{Rating}$
Reverse Gate Voltage	V_{GR}	5	8	—	V	$I_{GR} = 0.1mA$
Gate Trigger Current	I_{GT}	-5	—	20	μA	$R_{GS} = 10K, V_D = 5V$
Gate Trigger Voltage	V_{GT}	0.44	—	0.6	V	$R_{GS} = 100\Omega, V_D = 5V$
On-State Voltage	V_T	0.8	1.2	1.5	V	$I_T = 1A$ (pulse test)
Holding Current	I_H	0.3	1.0	4.0	mA	$R_{GK} = 1K, V_D = 5V$
SUBGROUP 3 (25°C Tests)						
Off-State Voltage — Critical Rate of Rise	dv_c/dt	30 15	60 30	—	$V/\mu s$	$R_{GK} = 1K, V_D = 30V$ (2N3030) $R_{GK} = 1K, V_D = 60V$ (2N3031)
Gate Trigger-on Pulse Width	$t_{pg}(\text{on})$	10	25	—	μs	$R_{GK} = 1K, V_D = 100V$ (2N3032)
Delay Time	t_d	—	.05	0.1	μs	$I_G = 10mA, I_T = 1A, V_D = 30V$
Rise Time	t_r	—	.01	—	μs	$I_G = 10mA, I_T = 1A, V_D = 30V$
Circuit Commutated Turn-off Time	t_g	—	.05	—	μs	$I_G = 10mA, I_T = 1A, V_D = 30V$
SUBGROUP 4 (150°C Tests)						
High Temp. Off-State Current	I_{DRM}	—	2	20	μA	$R_{GK} = 1K, V_{DRM} = \text{Rating}$
High Temp. Reverse Current	I_{RRM}	—	20	50	μA	$R_{GK} = 1K, V_{RRM} = \text{Rating}$
High Temp. Gate Trigger Voltage	V_{GT}	.10	.15	0.4	V	$R_{GS} = 100\Omega, V_D = 5V$
High Temp. Holding Current	I_H	.05	.30	2.0	mA	$R_{GK} = 1K, V_D = 5V$
SUBGROUP 5 (-65°C Tests)						
Low Temp. Gate Trigger Voltage	V_{GT}	0.44	0.8	0.95	V	$R_{GS} = 100\Omega, V_D = 5V$
Low Temp. Gate Trigger Current	I_{GT}	0	0.4	0.5	mA	$R_{GS} = 10K, V_D = 5V$
Low Temp. Holding Current	I_H	0.5	5.0	8	mA	$R_{GK} = 1K, V_D = 5V$

High Reliability Processing

The 2N3027-2N3032 series provides a complete range of high reliability processing from the standard devices that undergo extensive electrical testing, through JAN and JANTX levels. 100% processing, Group B, and Group C tests for JAN and JANTX devices is shown below. For further details, see MIL-S-19500/419(EL).

100% Screening TX Types

- High Temperature Storage
- Temperature Cycling
- Constant Acceleration
- Fine & Gross Hermetic Seal
- Electrical Test
- Burn-in
- Electrical Test

Group B Tests

- Subgroup 1 — Physical Dimensions
- Subgroup 2 — Solderability
 - Temperature Cycling
 - Thermal Shock
 - Constant Acceleration
 - Moisture Resistance
- Subgroup 3 — Surge Current
- Subgroup 4 — Blocking Life Test
- Subgroup 5 — Storage Life Test
- Subgroup 6 — Operating Life Test

Group C Tests

- Subgroup 1 — Shock
 - Vibration, Variable Frequency
- Subgroup 2 — Salt Atmosphere
- Subgroup 3 — Terminal Strength
- Subgroup 4 — High Temp. Anode Voltage — Critical rate or rise
- Subgroup 5 — Storage Life Test
- Subgroup 6 — Operating Life Test

TYPICAL CHARACTERISTICS
2N3027 — 2N3028 — 2N3029

1 Gate Trigger Current

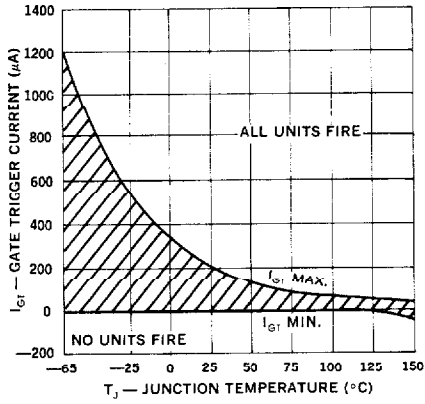

2 Gate Trigger Voltage

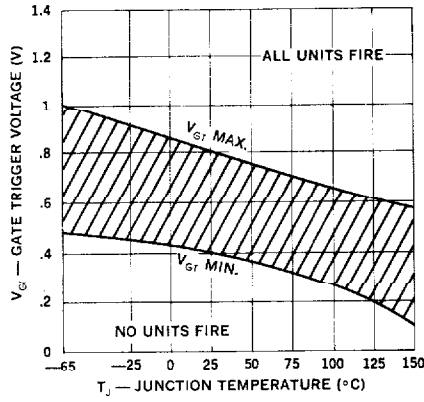

3 Min. Critical dv/dt (25°C — R Bias)

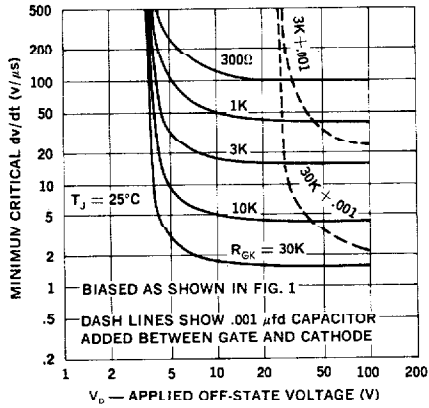

4 Min. Critical dv/dt (125°C — R Bias)

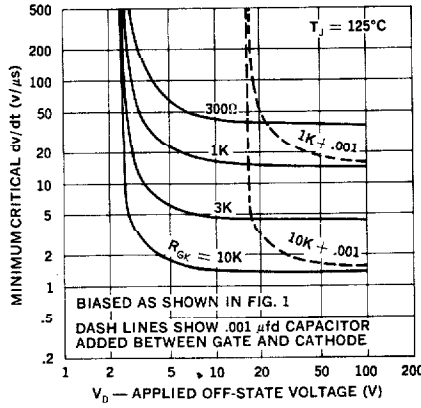

5 Max. Holding Current (Resistor Bias)

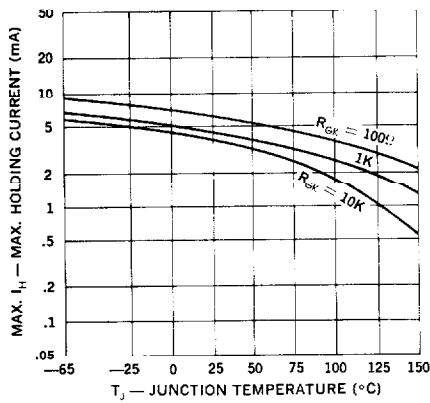

6 Min. Holding Current (Resistor Bias)

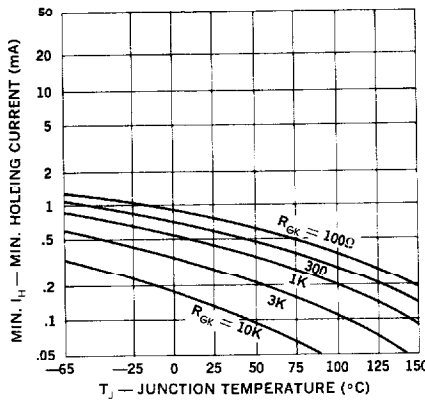

TYPICAL CHARACTERISTICS
2N3030 — 2N3031 — 2N3032

1 Gate Trigger Current

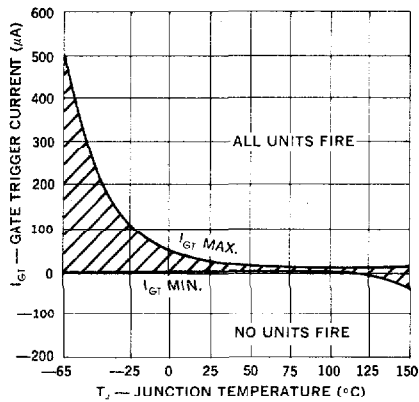

2 Gate Trigger Voltage

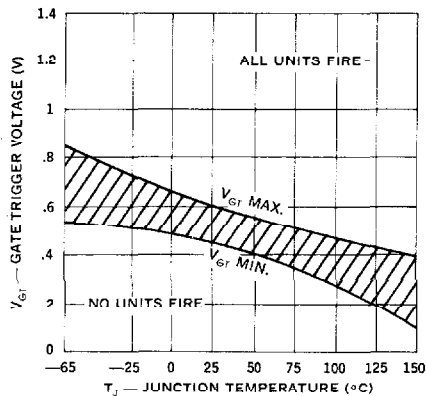

3 Min. Critical dv/dt (25°C — R Bias)

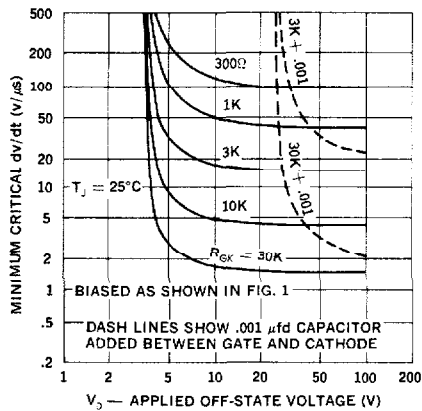

4 Min. Critical dv/dt (125°C — R Bias)

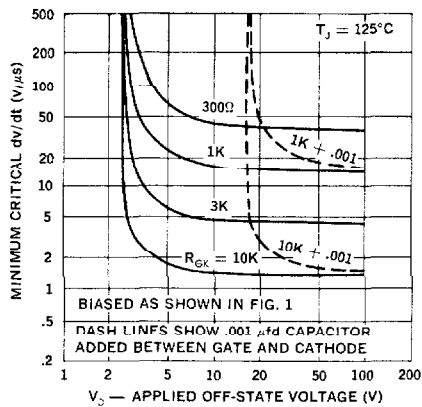

5 Max. Holding Current (Resistor Bias)

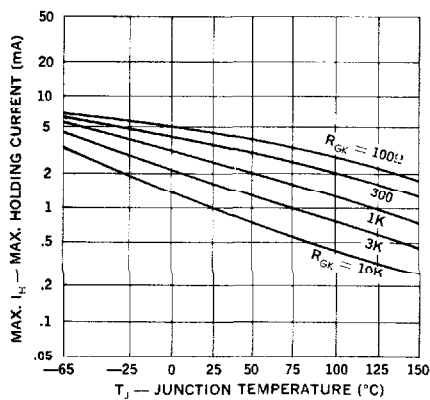

6 Min. Holding Current (Resistor Bias)

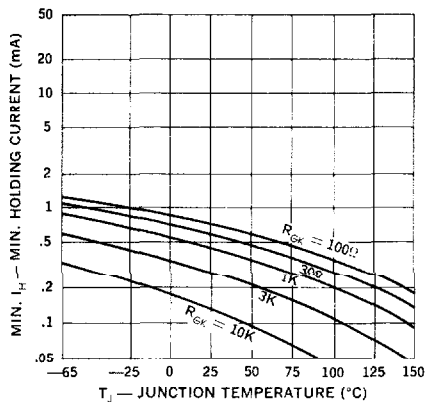

CURRENT RATINGS

C1 Forward on Current vs. Voltage

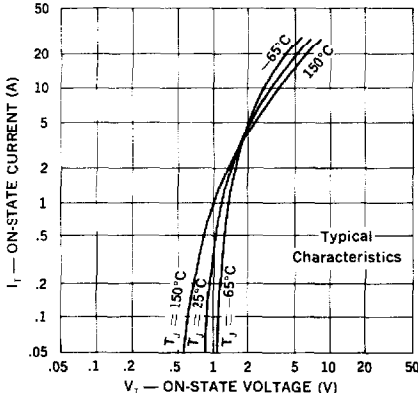

C2 Peak Current vs. Case Temperature
 P_A — POWER DISSIPATION (W)

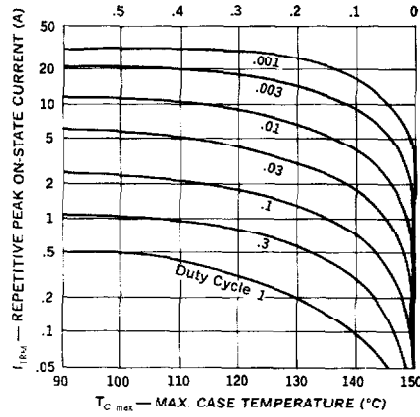

C3 Peak Current vs. Ambient Temperature
TO-18 Ratings (see note)

P_A — POWER DISSIPATION (W)

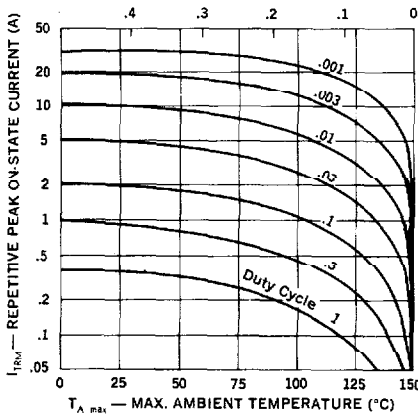

C4 Surge Current vs. Time

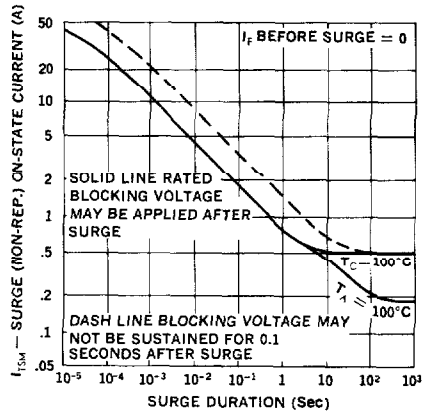

C5 Average Current vs. Case Temperature

P_A — POWER DISSIPATION (W)

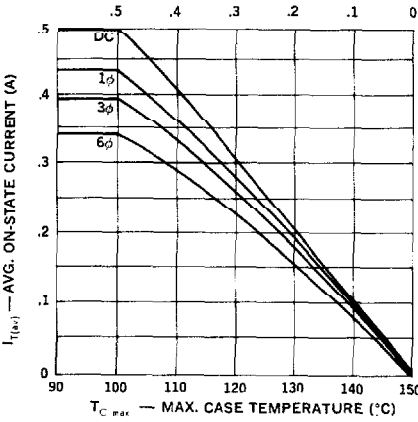

C6 Average Current vs. Ambient Temperature
TO-18 Ratings (see note)

P_A — POWER DISSIPATION (W)

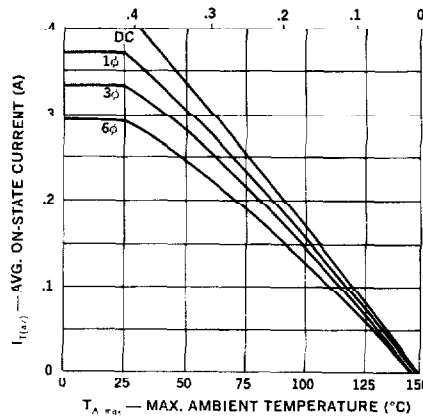

SWITCHING SPEEDS

S1 Maximum Delay Time t_d , Rise Time t_r , and Gate Trigger Pulse Width t_{pg} (on)

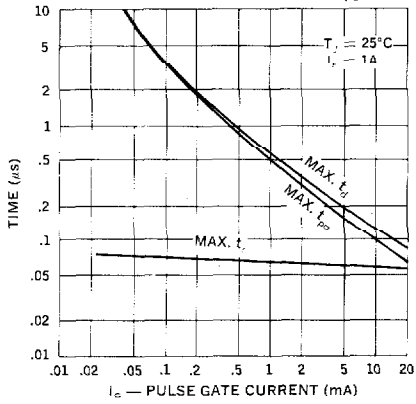

S2 Maximum Delay Time t_d , Rise Time t_r , and Gate Trigger Pulse Width t_{pg} (on)

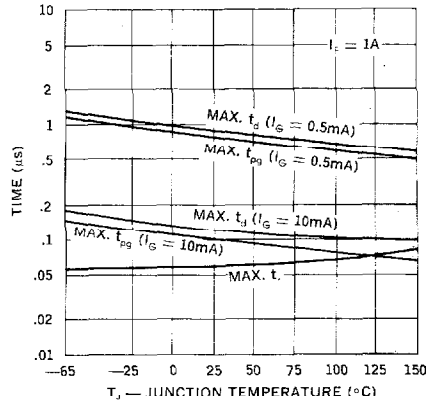

8

S3 Maximum Delay Time t_d , Rise Time t_r , and Gate Trigger Pulse Width t_{pg} (on)

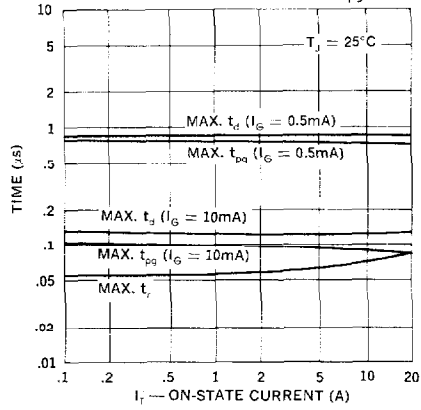

S4 Maximum Circuit Commutated Turn-off Time t_q

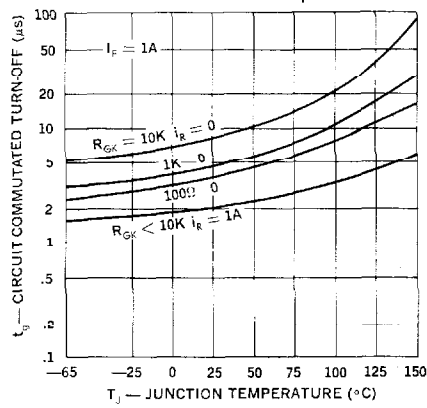

S5 Maximum Circuit Commutated Turn-off Time t_q

