

## Sensor/Actuator cable - SAC-8P-M 8MS/ 0,6-PUR/M 8FR - 1404202

Please be informed that the data shown in this PDF Document is generated from our Online Catalog. Please find the complete data in the user's documentation. Our General Terms of Use for Downloads are valid (<http://download.phoenixcontact.com>)



Sensor/Actuator cable, 8-position, PUR, Black RAL 9005, Plug straight M8, on Socket angled M8, Cable length: 0.6 m

### Product Features

- ✓ Easy and safe: 100% electrically tested plug-in components
- ✓ Our standard: robust halogen-free PUR cable
- ✓ Save space – with high-pos. plug-in connectors



### Key commercial data

Packing unit	1 PCE
GTIN	 4 046356 681223
Custom tariff number	85444290
Country of origin	GERMANY

### Technical data

#### General data

Rated current at 40°C	1.5 A
Rated voltage	30 V
Number of positions	8
Volume resistance	≤ 5 mΩ
Insulation resistance	≥ 100 MΩ
Length of cable	0.6 m
Ambient temperature (operation)	-25 °C ... 85 °C (Plug / socket)

#### General characteristics

Standards/regulations	M8 plug-in connector IEC 61076-2-104
Coding	A - standard

## Sensor/Actuator cable - SAC-8P-M 8MS/ 0,6-PUR/M 8FR - 1404202

### Technical data

#### General characteristics

Pollution degree	3
Degree of protection	IP65
Degree of protection	IP67
Degree of protection	IP68
Insertion/withdrawal cycles	≥ 100
Torque	0.2 Nm (M8 plug-in connectors)
Contact material	CuSn
Contact surface material	Ni/Au
Contact carrier material	TPU GF
Material of grip body	TPU, hardly inflammable, self-extinguishing
Material, knurls	Zinc die-cast, nickel-plated
Status display	No

#### Conductor data

Cable abbreviation	Li9Y11Y
UL AWM style	20549
Conductor cross section	8x 0.14 mm <sup>2</sup> (signal line)
AWG signal line	26
Conductor structure signal line	18x 0.10 mm
Core diameter including insulation	1 mm ±0.02 mm (signal line)
Thickness, insulation	≥ 0.21 mm (signal line)
Thickness, insulation	≥ 0.38 mm (Outer cable sheath)
Wire colors	white, brown, green, yellow, gray, pink, blue, red
Overall twist	8 wires around filler to the core
Length of twist, overall twist	58 mm
External sheath, color	Black-gray RAL 7021
External cable diameter D	5.1 mm ±0.15 mm
Smallest bending radius, fixed installation	25.5 mm
Smallest bending radius, movable installation	51 mm
Number of bending cycles	4000000
Bending radius	51 mm
Traversing path	10 m
Traversing rate	3 m/s
Acceleration	10 m/s <sup>2</sup>
Outer sheath, material	PUR
Material, filler	PE
Material conductor insulation	PP
Conductor material	Bare Cu litz wires

## Sensor/Actuator cable - SAC-8P-M 8MS/ 0,6-PUR/M 8FR - 1404202

### Technical data

#### Conductor data

Insulation resistance	1 GΩ*km (at 20 °C)
Conductor resistance	139 Ω/km (at 20 °C)
Nominal voltage, conductor	≤ 300 V AC
Test voltage, conductor	≥ 3000 V AC (Spark test)
Flame resistance	according to UL 758/1581 (horizontal)
Flame resistance	In accordance with UL 758/1581 FT2
Halogen-free	in accordance with DIN VDE 0472 part 815
Halogen-free	in accordance with DIN EN 50267-2-1
Resistance to oil	According to DIN EN 60811-2-1, 168 h at 100°C
Other resistance	hydrolysis and microbe resistant
Other resistance	Resistant to salt water
Other resistance	Low adhesion
Other resistance	abrasion-resistant
Ambient temperature (operation)	-40 °C ... 80 °C (cable, fixed installation)
Ambient temperature (operation)	-25 °C ... 80 °C (cable, flexible installation)

### Classifications

#### ETIM

ETIM 3.0	EC001855
ETIM 4.0	EC001855
ETIM 5.0	EC001855

#### UNSPSC

UNSPSC 11	31251501
UNSPSC 12.01	31251501
UNSPSC 13.2	31251501
UNSPSC 6.01	31251501
UNSPSC 7.0901	31251501

#### eCl@ss

eCl@ss 4.0	27060306
eCl@ss 4.1	27060306
eCl@ss 5.0	27061801
eCl@ss 5.1	27061801
eCl@ss 6.0	27061801
eCl@ss 7.0	27061801

## Sensor/Actuator cable - SAC-8P-M 8MS/ 0,6-PUR/M 8FR - 1404202

### Accessories

#### Accessories

#### Marking

##### Insert label - PABA WH/15 - 1013151



Insert label, Strip, white, Unlabeled, Can be labeled with: Plotter, Mounting type: Thread on, Cable diameter: 0.6-50 mm, Lettering field: 15 x 4 mm

---

##### Insert label - PABA YE/15 - 1013698



Insert label, Strip, yellow, Unlabeled, Can be labeled with: Plotter, Mounting type: Thread on, Cable diameter: 0.6-50 mm, Lettering field: 15 x 4 mm

---

##### Insert label - PABA RD/15 - 1013944



Insert label, Strip, red, Unlabeled, Can be labeled with: Plotter, Mounting type: Thread on, Cable diameter: 0.6-50 mm, Lettering field: 15 x 4 mm

---

##### Conductor marker carrier - PATO 2/15 - 1013122



Conductor marker carrier, transparent, Unlabeled, Mounting type: Clip on, Cable diameter: 2.8-4.4 mm, Lettering field: 4 x 15 mm

---

##### Conductor marker carrier - PATO 3/15 - 1013135



Conductor marker carrier, transparent, Unlabeled, Mounting type: Clip on, Cable diameter: 4.4-6.7 mm, Lettering field: 4 x 15 mm

## Sensor/Actuator cable - SAC-8P-M 8MS/ 0,6-PUR/M 8FR - 1404202

### Accessories

---

Conductor marker carrier - PATO 4/15 - 1013148



Conductor marker carrier, transparent, Unlabeled, Mounting type: Clip on, Cable diameter: 6.7-10 mm, Lettering field: 4 x 15 mm

Marker pen - B-STIFT - 1051993



Marker pen, for manual labeling of unprinted Zack strips, smear-proof and waterproof, line thickness 0.5 mm

### Protection and sealing elements

Sealing cap - PROT-M 8 FS-PA-CHAIN - 1430857



M8 sealing cap made of plastic with fixing band for sensor cables, for M8 plugs

Screw plug - PROT-M 8 MS-PA-CHAIN - 1430860



M8 sealing cap made of plastic with fixing band for sensor cables, for M8 sockets

### Tools

---

# Sensor/Actuator cable - SAC-8P-M 8MS/ 0,6-PUR/M 8FR - 1404202

## Accessories

Torque screwdriver - TSD 02 SAC - 1208487



Torque screwdriver, with preset torque of 0.2 Nm and 4 mm hexagonal drive for M8 connectors

Tool - SAC BIT M8-D10 - 1208461



Nut for assembling sensor/actuator cables with M8 connector and for M8 connectors with QUICKON fast connection technology, for 4 mm hexagonal drive

## Drawings

Schematic diagram

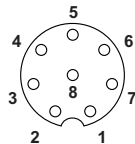

Connector pin assignment of M8 socket, 8-pos., view of socket side

Schematic diagram

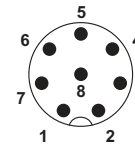

M8 plug pin assignment, 8-pos., view of pin side

Cable cross section



PUR halogen-free black [PUR]

Circuit diagram

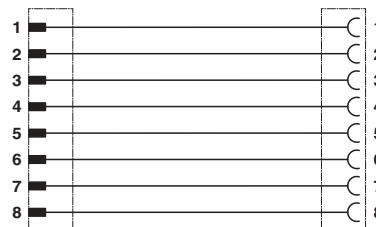

Contact assignment of M8 plugs/sockets

# Sensor/Actuator cable - SAC-8P-M 8MS/ 0,6-PUR/M 8FR - 1404202

Dimensioned drawing

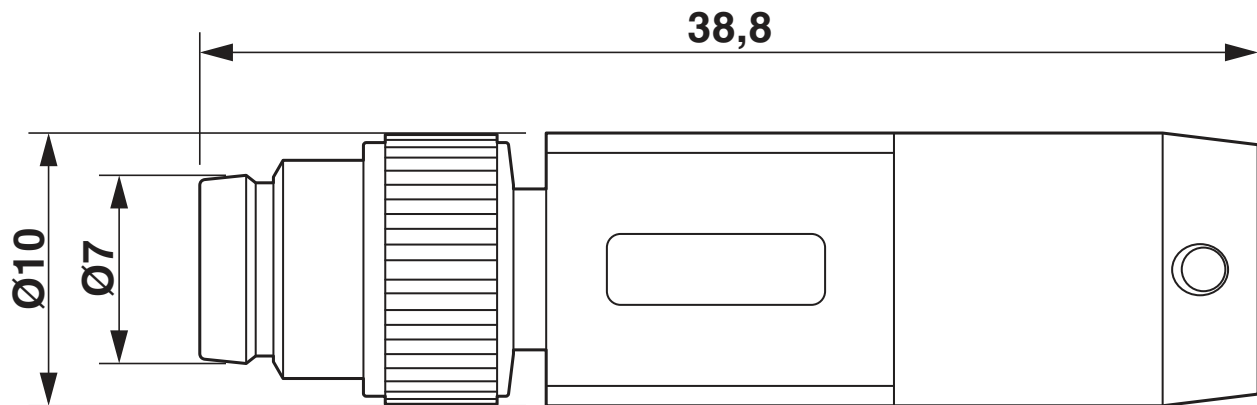

# Sensor/Actuator cable - SAC-8P-M 8MS/ 0,6-PUR/M 8FR - 1404202

Dimensioned drawing

