



## GSM 900/1800MHz

### Features

- Omni directional Antenna
- Miniature Size:
  - Length = 16mm
  - DIA = 7mm
- VSWR <2
- 50Ω Impedance
- OdBi Gain (nominal)

### Applications

- General Low Power Radio
- M2M Applications
- Telemetry



### Description

The BEAD Antenna provides a compact PCB mounting solution where a high performance is required from a small space.

Available as straight or 90 degree mount this antenna is a general purpose omni-directional.

### Ordering Information

PART No	Description
ANT-BEAD-GSM	Miniature Bead Antenna
ANT-BEAD-GSM90	Miniature Bead Antenna R/A Leg

## Technical Data

### Parameter Description

Frequency Band	900 / 1800MHz
Nominal Impedance	50 ohm
Polarization	Vertical
Return Loss Please See Data	
V. S. W. R	2.5: 1

### Mechanical

Antenna Type	External Antenna
Antenna Material	POM
Antenna Dimensions	22.7mm $\pm$ 2
Antenna Color	Black
Operating Temperature Range	-20°C~+60°C
Storage Temperature Range	-30°C~+70°C

## Notes

Optimum antenna performance is achieved with a Ground Plane. The following data was characterised with the setup as below  
Test PCB, Size: 137(L) x 57(W) x 1(H) mm (for ref.)

## Customisation

We are able to provide custom tuning of these antenna for specific customer applications. Please contact our sales dept for further information.

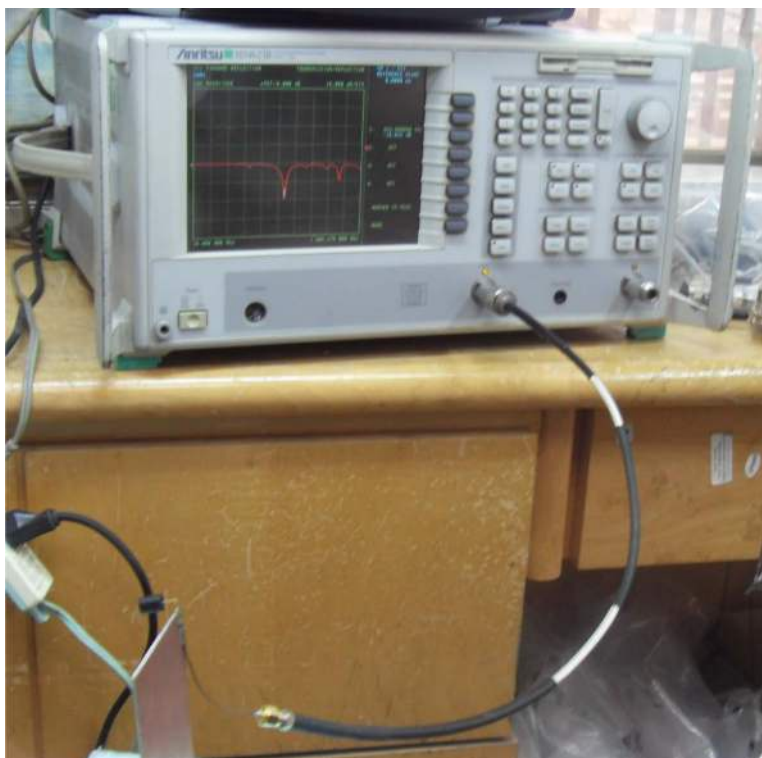

## Straight Leg Version

### Mechanical Detail

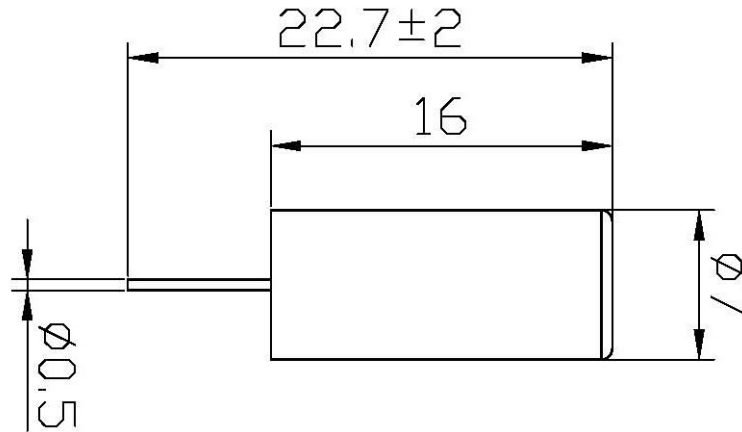

### Performance Data — SMITH CHART

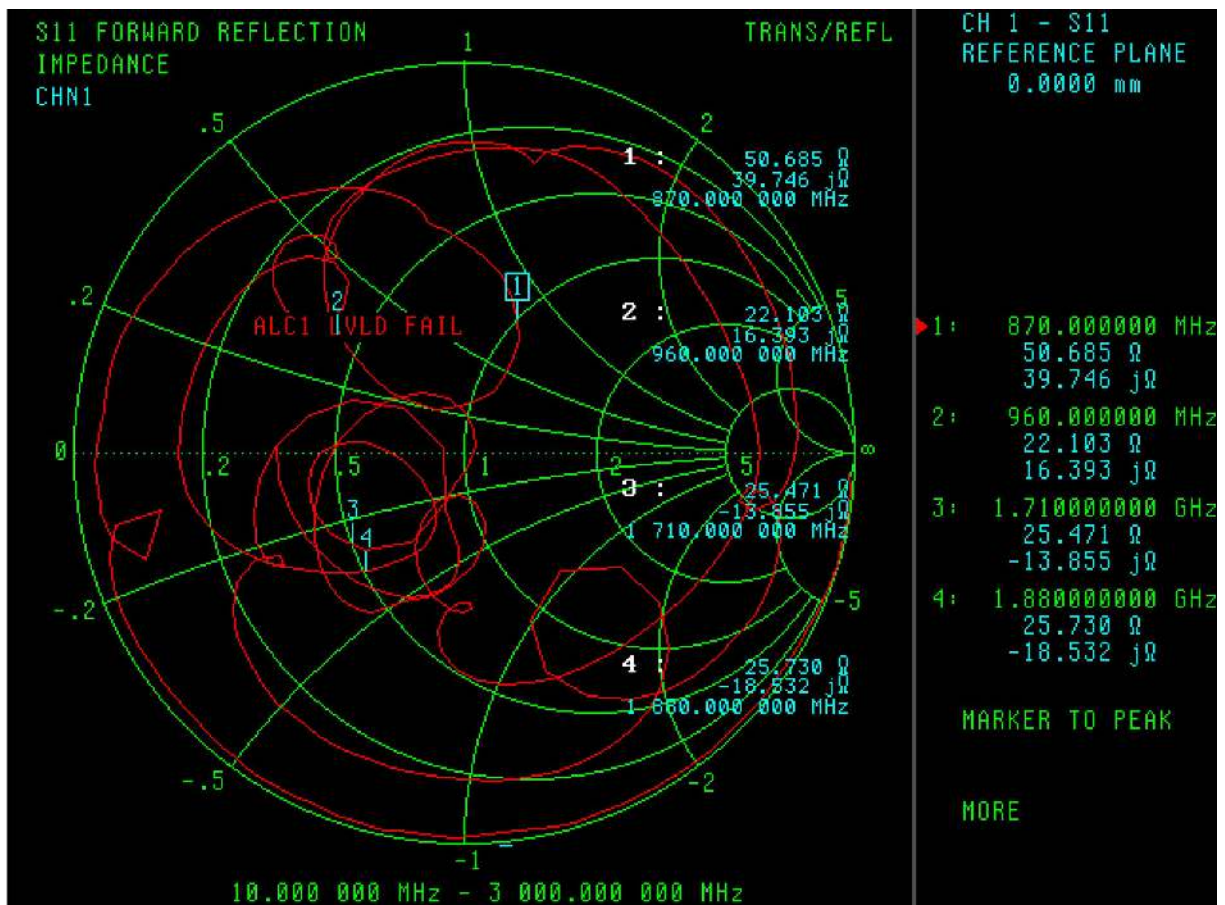

## Performance Data — VSWR

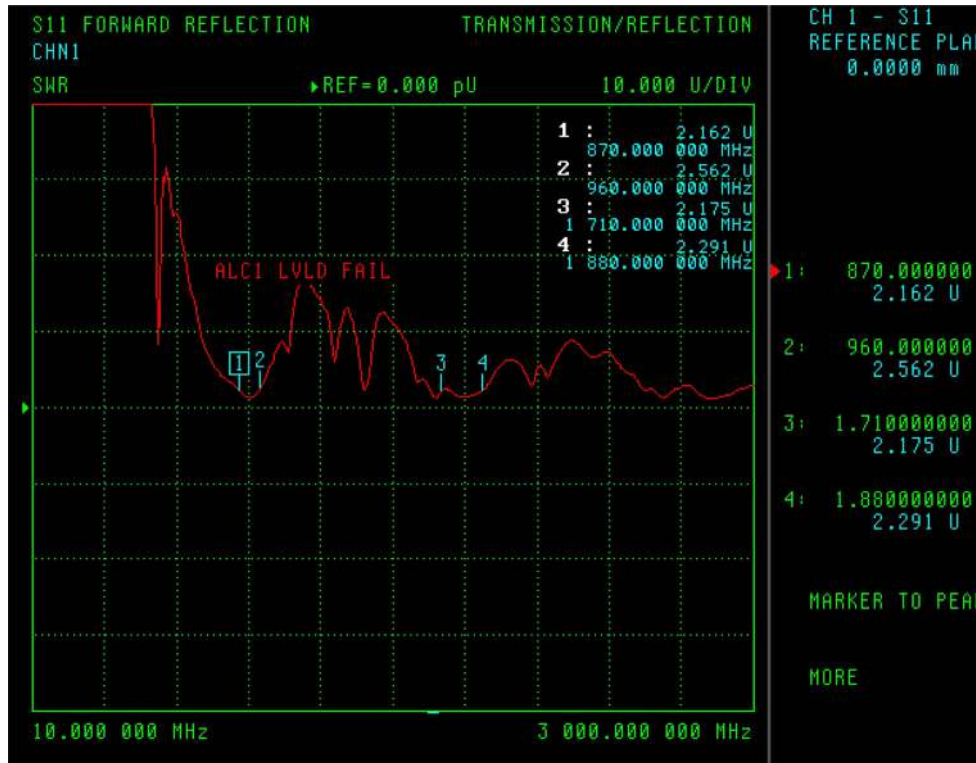

## Performance Data — RETURN LOSS

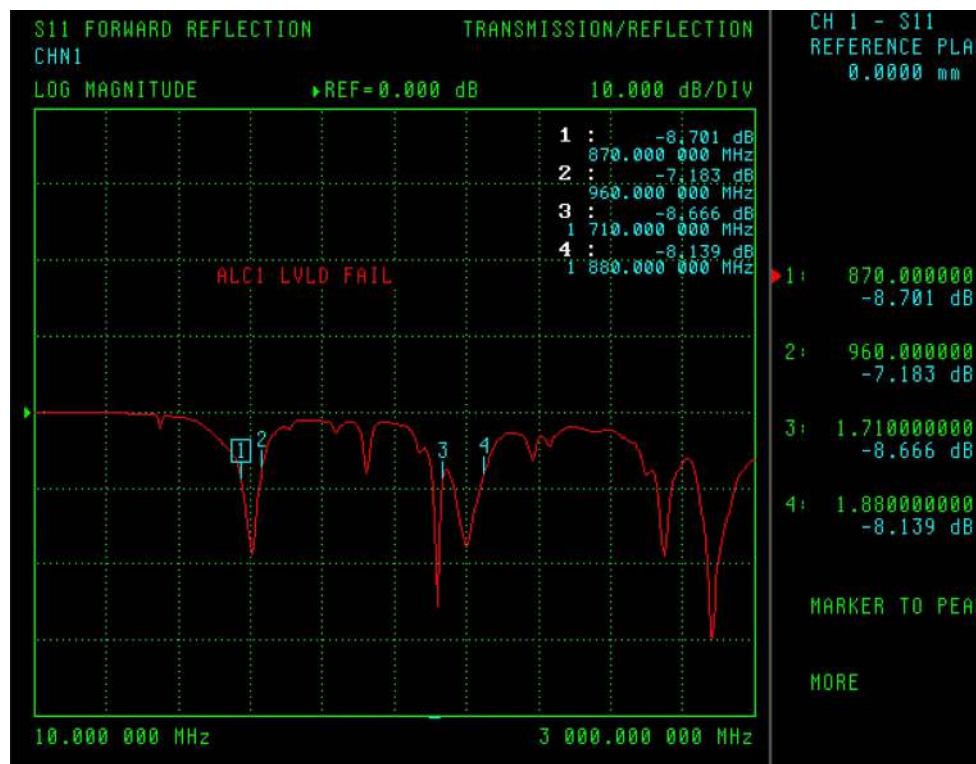

## Bent Leg Version

### Mechanical Detail

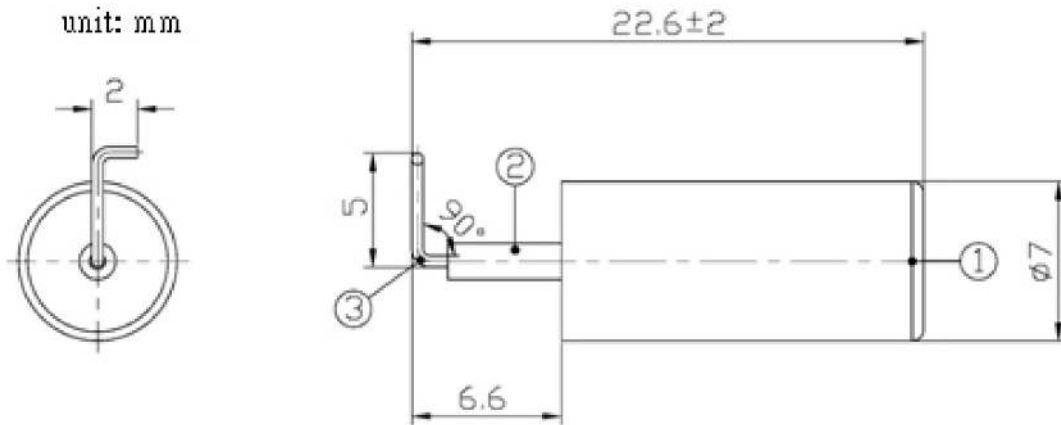

### Performance Data — SMITH CHART

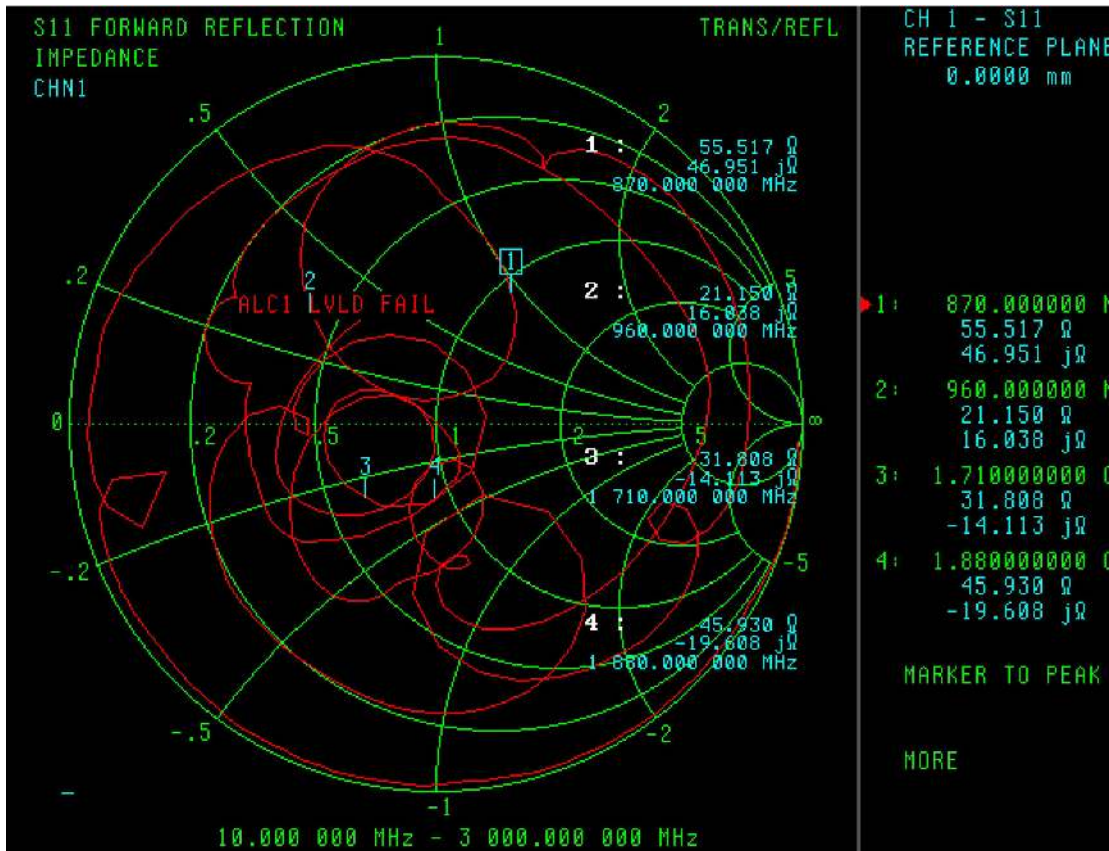

## Performance Data — VSWR



## Performance Data — RETURN LOSS

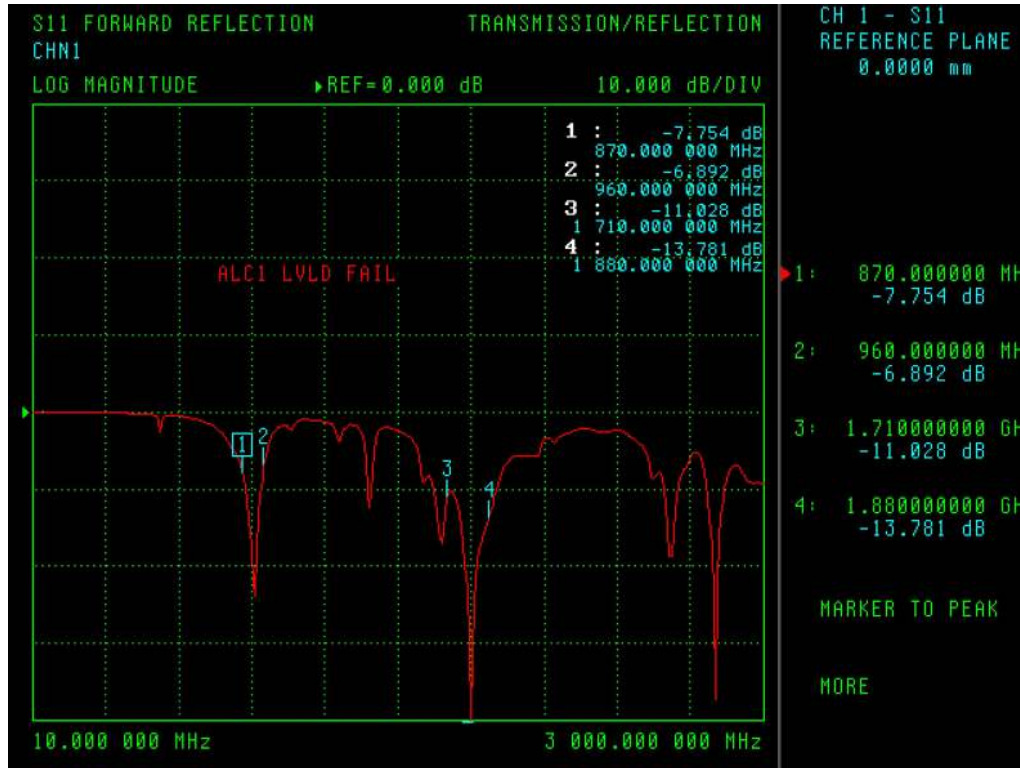

**RF Solutions Ltd. Recycling Notice**  
Meets the following EC Directives:

**DO NOT**  
**Discard with normal waste, please recycle.**

**ROHS Directive 2011/65/EU and amendment 2015/863/EU**  
Specifies certain limits for hazardous substances.

**WEEE Directive 2012/19/EU**

Waste electrical & electronic equipment. This product must be disposed of through a licensed WEEE collection point. RF Solutions Ltd., fulfills its WEEE obligations by membership of an approved compliance scheme.

Environment Agency Producer Registration Number: **WEE/JB0104WV**.

**Waste Batteries and Accumulators Directive 2006/66/EC**

Where batteries are fitted, before recycling the product, the batteries must be removed and disposed of at a licensed collection point.

**Disclaimer**

Whilst the information in this document is believed to be correct at the time of issue, RF Solutions Ltd does not accept any liability whatsoever for its accuracy, adequacy or completeness. No express or implied warranty or representation is given relating to the information contained in this document. RF Solutions Ltd reserves the right to make changes and improvements to the product(s) described herein without notice. Buyers and other users should determine for themselves the suitability of any such information or products for their own particular requirements or specification(s). RF Solutions Ltd shall not be liable for any loss or damage caused as a result of user's own determination of how to deploy or use RF Solutions Ltd's products. Use of RF Solutions Ltd products or components in life support and/or safety applications is not authorised except with express written approval. No licences are created, implicitly or otherwise, under any of RF Solutions Ltd's intellectual property rights. Liability for loss or damage resulting or caused by reliance on the information contained herein or from the use of the product (including liability resulting from negligence or where RF Solutions Ltd was aware of the possibility of such loss or damage arising) is excluded. This will not operate to limit or restrict RF Solutions Ltd's liability for death or personal injury resulting from its negligence.