

HA1630D04/05/06 Series

Ultra-Small Low Voltage Operation CMOS Dual Operational Amplifier

R03DS0111EJ0100

Rev.1.00

Nov. 30, 2017

Description

The HA1630D04/05/06 are high slew rate dual CMOS Operational Amplifiers realizing low voltage operation, low input offset voltage and low supply current. In addition to a low operating voltage from 1.8V, these device output can achieve full swing output voltage capability extending to either supply. Available in an ultra-small TSSOP-8 and MPAK-8 package that occupy more small area against the SOP-8.

Features

- Low power and single supply operation $V_{DD} = 1.8$ to 5.5 V
- Low input offset voltage $V_{IO} = 4.0$ mV Max
- Low supply current (per channel) $I_{DD} = 200$ μ A Typ (HA1630D04)
 $I_{DD} = 400$ μ A Typ (HA1630D05)
 $I_{DD} = 800$ μ A Typ (HA1630D06)
- High slew rate $SR = 2$ V/ μ s Typ (HA1630D04)
 $SR = 4$ V/ μ s Typ (HA1630D05)
 $SR = 8$ V/ μ s Typ (HA1630D06)
- Maximum output voltage $V_{OH} = 2.9$ V Min (at $V_{DD} = 3.0$ V)
- Low input bias current $I_{IB} = 1$ pA Typ

Ordering Information

Type No.	Package Name	Package Code
HA1630D04T	TTP-8DA	PTSP0008JC-B
HA1630D05T		
HA1630D06T		
HA1630D04MM	MPAK-8	PLSP0008JC-A
HA1630D05MM		
HA1630D06MM		

Pin Arrangement

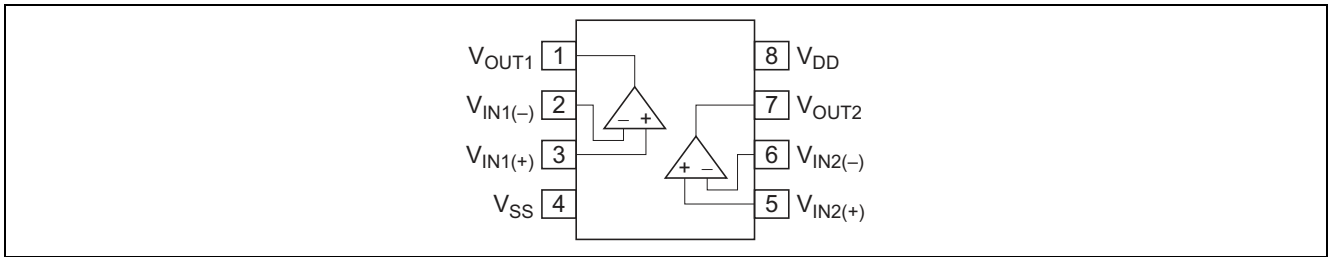

Equivalent Circuit (per one channel)

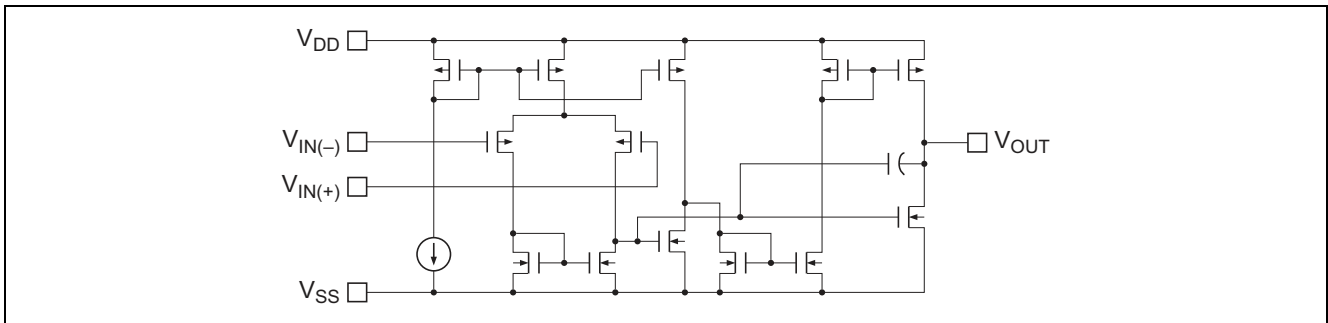

Absolute Maximum Ratings

(Ta = 25°C)

Items	Symbol	Ratings	Unit	Note
Supply voltage	V _{DD}	7	V	
Differential input voltage	V _{IN(diff)}	-V _{DD} to +V _{DD}	V	
Input voltage	V _{IN}	-0.3 to +V _{DD}	V	*1
Power dissipation	P _T	240/145	mW	TTP-8DA/MMPAK-8 *2
Operating temp. Range	Topr	-40 to +85	°C	
Storage temp. Range	Tstg	-55 to +125	°C	

Notes: 1. Do not apply Input Voltage exceeding V_{DD} or 7 V.2. The value of PTSP0008JC-B (TTP-8DAV) / PLSP0008JC-A (MMPAK-8). It computes from heat resistance $\theta_{ja} = 520^{\circ}\text{C}/\text{W}$, and $690^{\circ}\text{C}/\text{W}$ each other.

Electrical Characteristics

(V_{DD} = 3.0 V, Ta = 25°C)

Items	Symbol	Min	Typ	Max	Unit	Test Condition
Input offset voltage	V _{IO}	—	—	4.0	mV	V _{in} = 1.5 V
Input offset current	I _{IO}	—	(1.0)	—	pA	V _{in} = 1.5 V
Input bias current	I _{IB}	—	(1.0)	—	pA	V _{in} = 1.5 V
Output high voltage	V _{OH}	2.9	—	—	V	R _L = 100 k Ω
Output source current	I _{O SOURCE}	100	200	—	μA	V _{OH} = 2.5 V (HA1630D04)
		200	400	—		V _{OH} = 2.5 V (HA1630D05)
		400	800	—		V _{OH} = 2.5 V (HA1630D06)
Output low voltage	V _{OL}	—	—	0.1	V	R _L = 100 k Ω
Output sink current	I _{O SINK}	—	(5.0)	—	mA	V _{OL} = 0.5 V (HA1630D04)
		—	(6.0)	—		V _{OL} = 0.5 V (HA1630D05)
		—	(6.5)	—		V _{OL} = 0.5 V (HA1630D06)
Common mode input voltage range	V _{CM}	-0.05 to 2.1	—	—	V	(HA1630D04, HA1630D05)
		0 to 1.9	—	—		(HA1630D06)
Slew rate	SR	—	(2.0)	—	V/ μs	C _L = 20 pF (HA1630D04)
		—	(4.0)	—		C _L = 20 pF (HA1630D05)
		—	(8.0)	—		C _L = 20 pF (HA1630D06)
Voltage gain	A _V	60	90	—	dB	
Gain bandwidth product	BW	—	(2100)	—	kHz	C _L = 20 pF (HA1630D04)
		—	(3300)	—		C _L = 20 pF (HA1630D05)
		—	(3600)	—		C _L = 20 pF (HA1630D06)
Power supply rejection ratio	PSRR	50	70	—	dB	
Common mode rejection ratio	CMRR	50	70	—	dB	
Supply current	I _{DD}	—	400	800	μA	R _L = ∞ (HA1630D04)
		—	800	1600		R _L = ∞ (HA1630D05)
		—	1600	3400		R _L = ∞ (HA1630D06)

Notes: 1. In the case of continuous current flow, use a sink current of under 4 mA.

2. () : Design specification

Table of Graphs

Electrical Characteristics			HA1630D04 Figure	HA1630D05 Figure	HA1630D06 Figure	Test Circuit
Supply current	I_{DD}	vs Supply voltage	1-1	2-1	3-1	2
		vs Ambient temperature	1-2	2-2	3-2	
Output high voltage	V_{OH}	vs Output source current	1-3	2-3	3-3	4
		vs Supply voltage	1-4	2-4	3-4	
Output source current	$I_{O\ SOURCE}$	vs Ambient temperature	1-5	2-5	3-5	6
Output low voltage	V_{OL}	vs Output sink current	1-6	2-6	3-6	5
Output sink current	$I_{O\ SINK}$	vs Ambient temperature	1-7	2-7	3-7	6
Input offset voltage	V_{IO}	Distribution	1-8	2-8	3-8	1
		vs Supply voltage	1-9	2-9	3-9	
		vs Ambient temperature	1-10	2-10	3-10	
Common mode input voltage range	V_{CM}	vs Ambient temperature	1-11	2-11	3-11	7
Power supply rejection ratio	PSRR	vs Frequency	1-12	2-12	3-12	1
Common mode rejection ratio	CMRR	vs Frequency	1-13	2-13	3-13	7
Voltage gain & phase angle	A_V	vs Frequency	1-14	2-14	3-14	10
Input bias current	I_{IB}	vs Ambient temperature	1-15	2-15	3-15	3
		vs Input voltage	1-16	2-16	3-16	
Slew Rate (rising)	SRr	vs Ambient temperature	1-17	2-17	3-17	9
Slew Rate (falling)	SRf	vs Ambient temperature	1-18	2-18	3-18	
Slew rate		Large signal transient response	1-19	2-19	3-19	
		Small signal transient response	1-20	2-20	3-20	
Total harmonic distortion + noise	(0 dB)	vs. Output voltage p-p	1-21	2-21	3-21	8
	(40 dB)	vs. Output voltage p-p	1-22	2-22	3-22	
Maximum p-p output voltage		vs Frequency	1-23	2-23	3-23	
Voltage noise density		vs Frequency	1-24	2-24	3-24	
Channel separation		vs Frequency	1-25	2-25	3-25	

Main Characteristics (HA1630D04)

Figure 1-1. HA1630D04
Supply Current vs. Supply Voltage

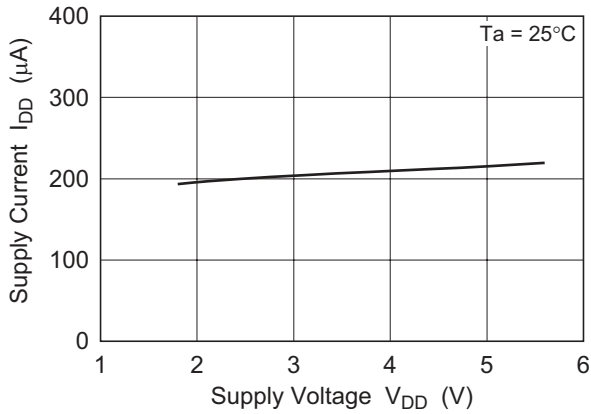

Figure 1-2. HA1630D04
Supply Current vs. Ambient Temperature

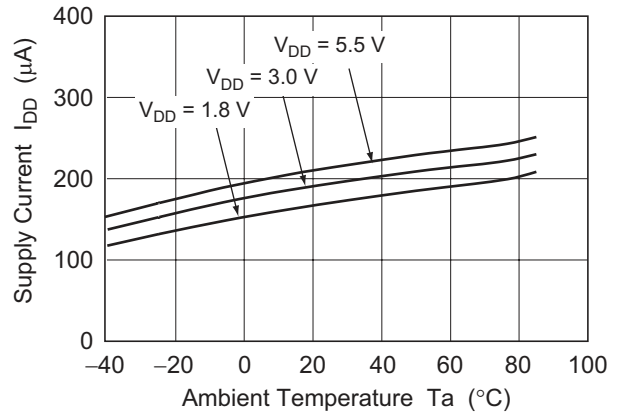

Figure 1-3. HA1630D04
Output High Voltage vs. Output Source Current

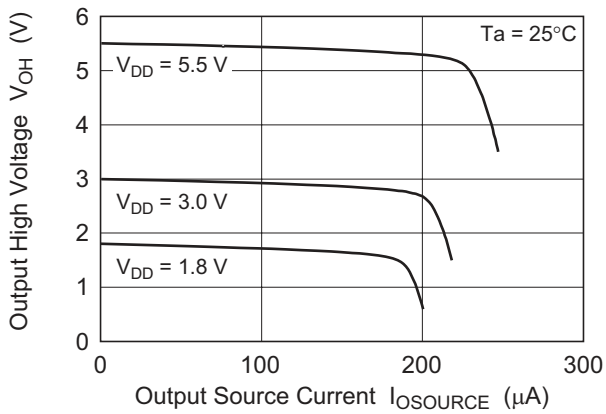

Figure 1-4. HA1630D04
Output High Voltage vs. Supply Voltage

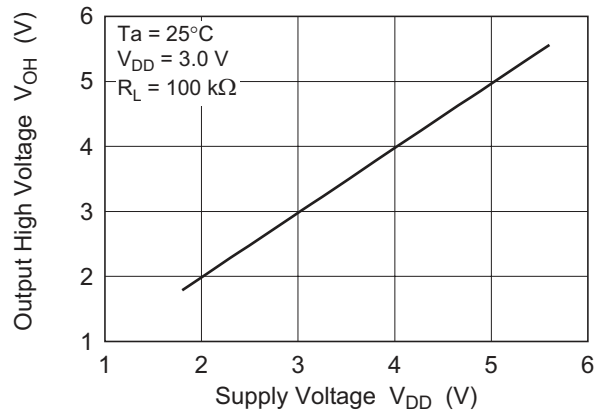
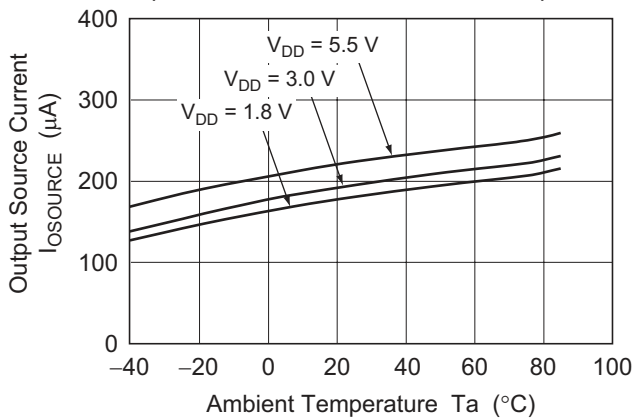

Figure 1-5. HA1630D04
Output Source Current vs. Ambient Temperature



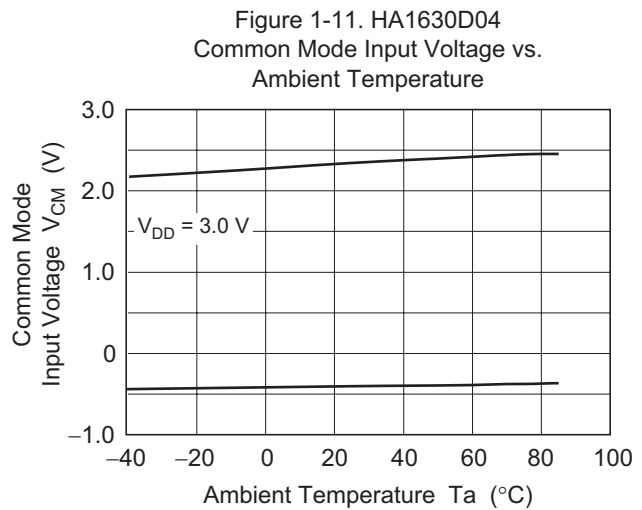
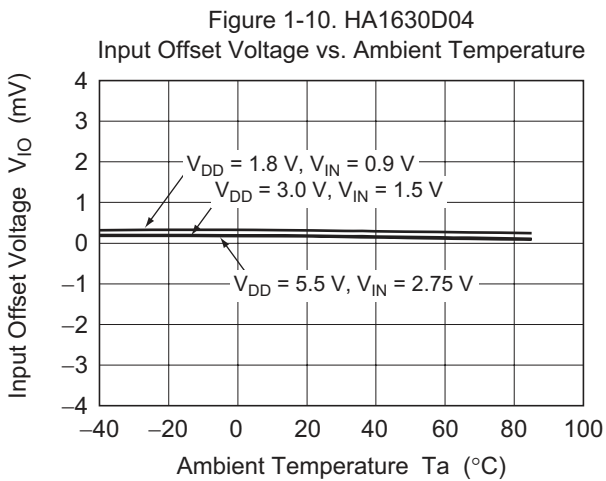
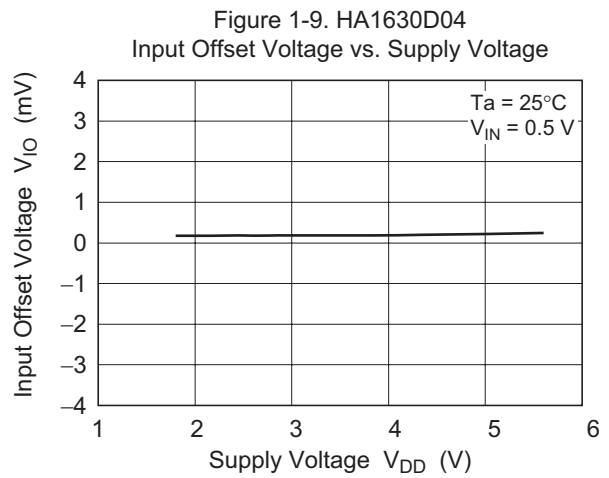
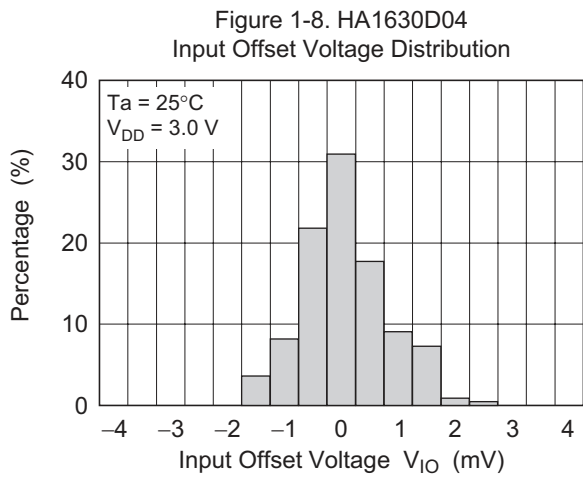
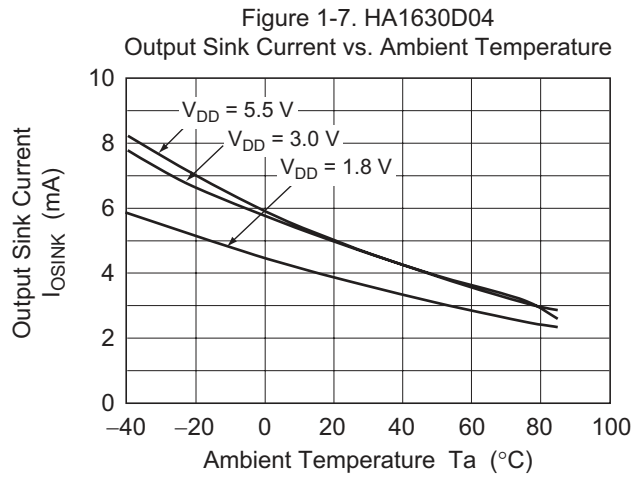
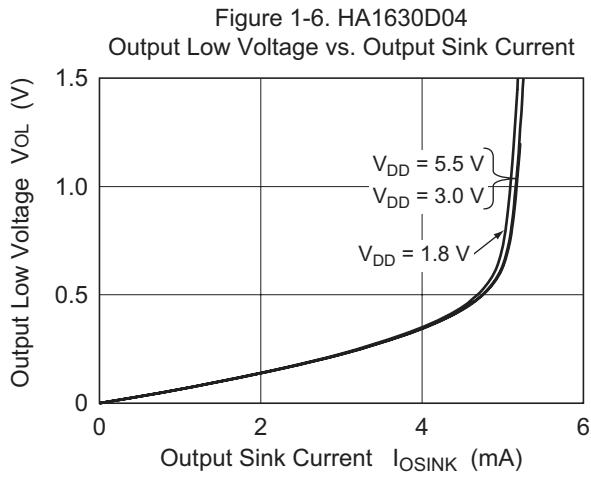

Figure 1-12. HA1630D04
Power Supply Rejection Ratio vs. Frequency

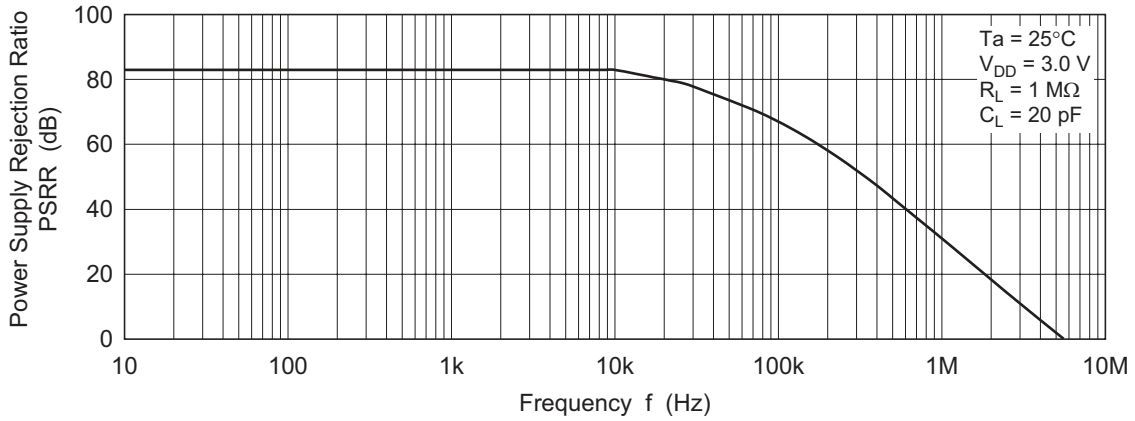

Figure 1-13. HA1630D04
Common Mode Rejection Ratio vs. Frequency

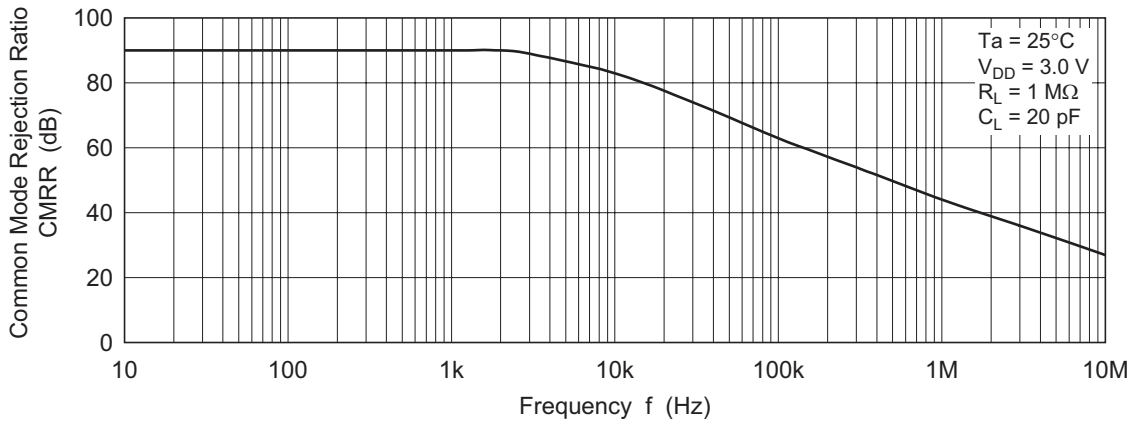
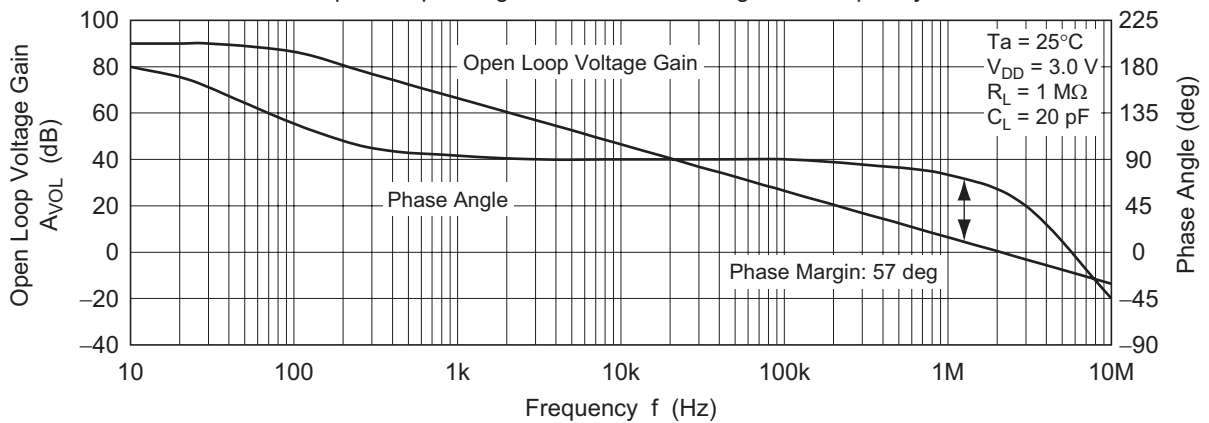

Figure 1-14. HA1630D04
Open Loop Voltage Gain and Phase Angle vs. Frequency



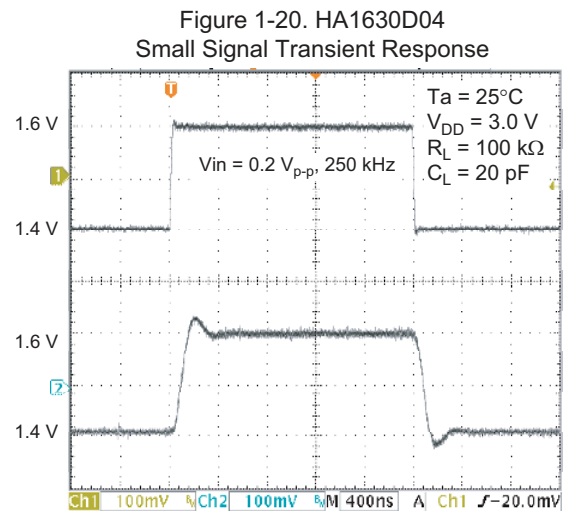
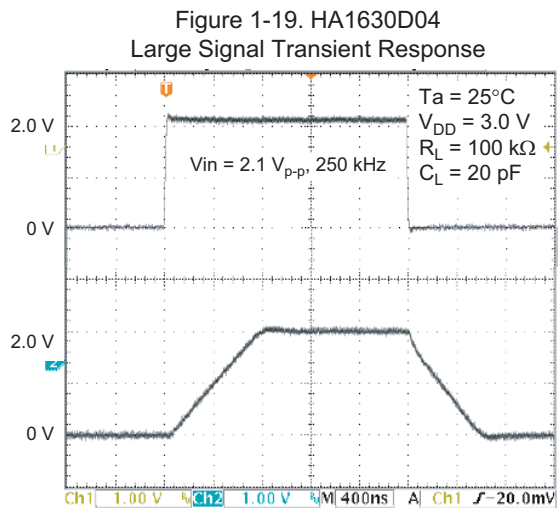
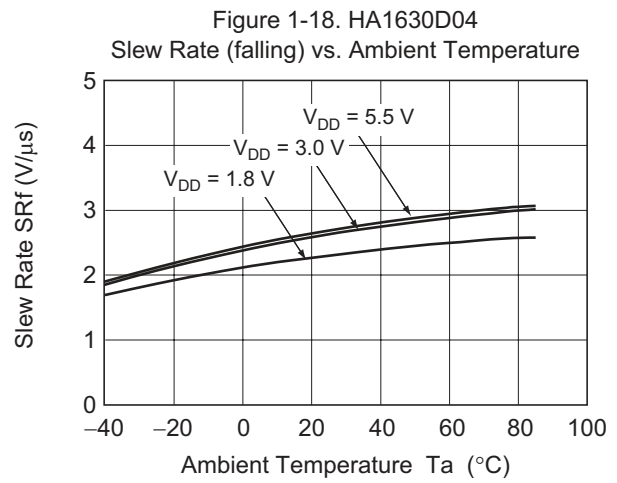
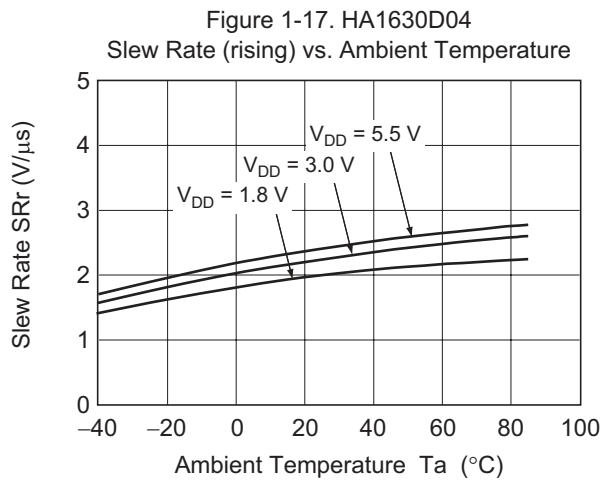
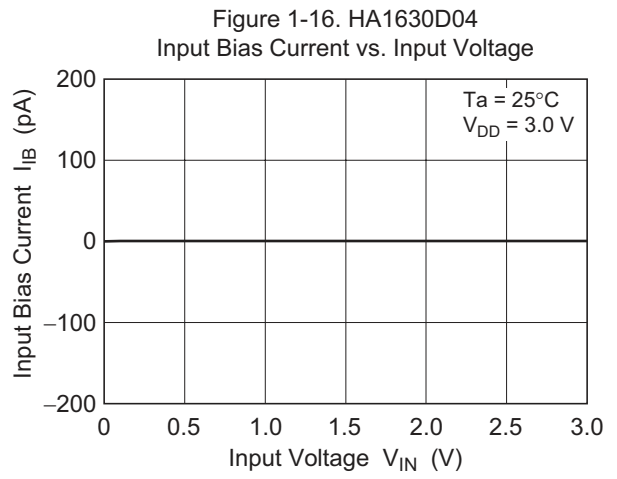
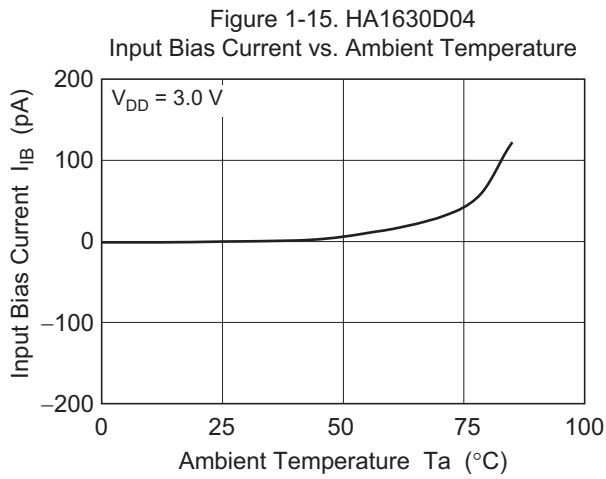

Figure 1-21. HA1630D04
Total Harmonic Distortion + Noise vs.
Output Voltage p-p

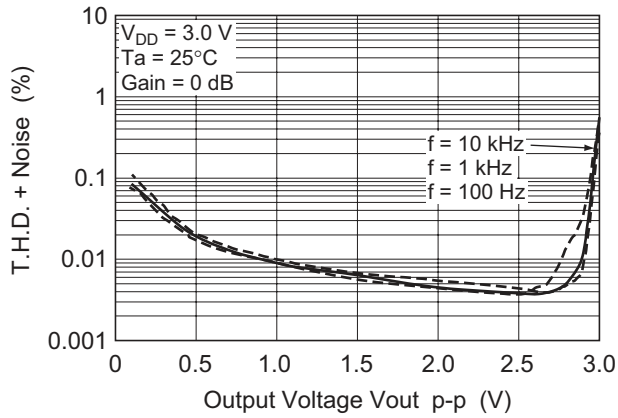

Figure 1-22. HA1630D04
Total Harmonic Distortion + Noise vs.
Output Voltage p-p

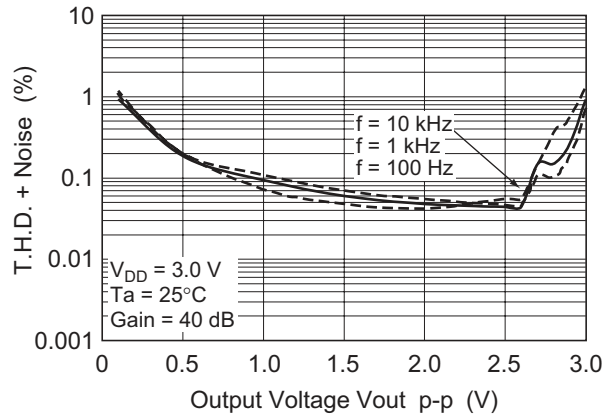

Figure 1-23. HA1630D04
Voltage Output p-p vs. Frequency

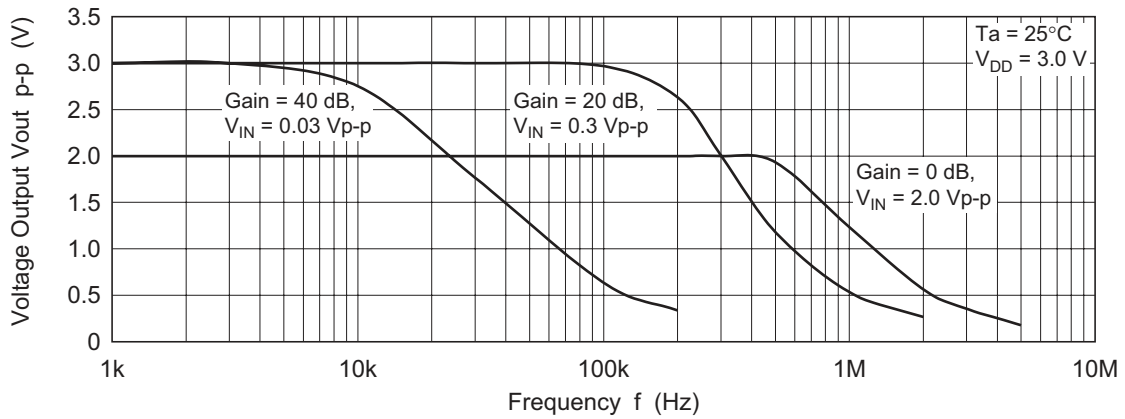

Figure 1-24. HA1630D04
Voltage Noise Density vs. Frequency

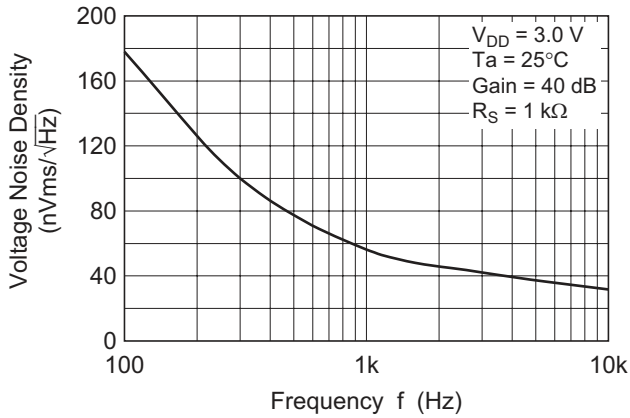
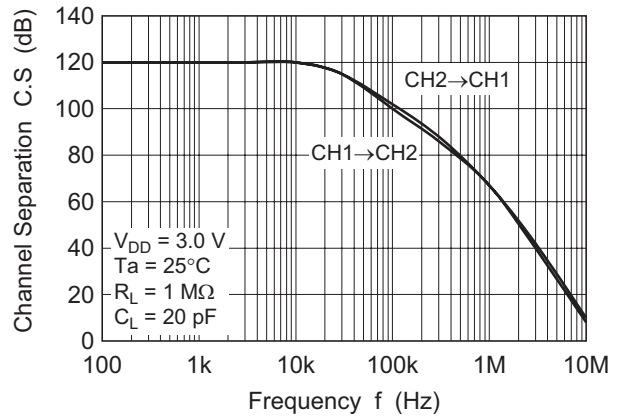
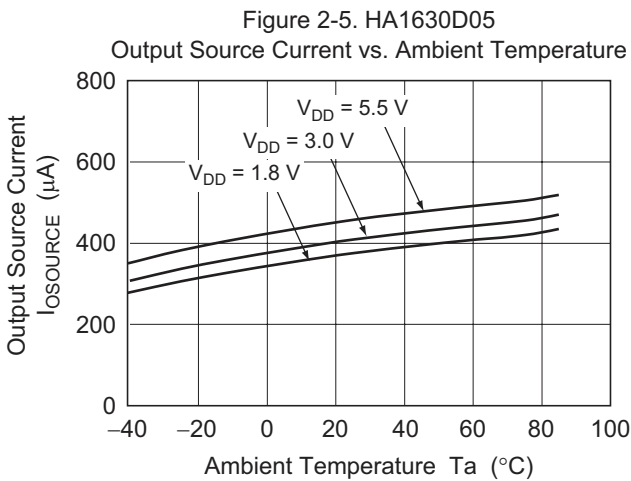
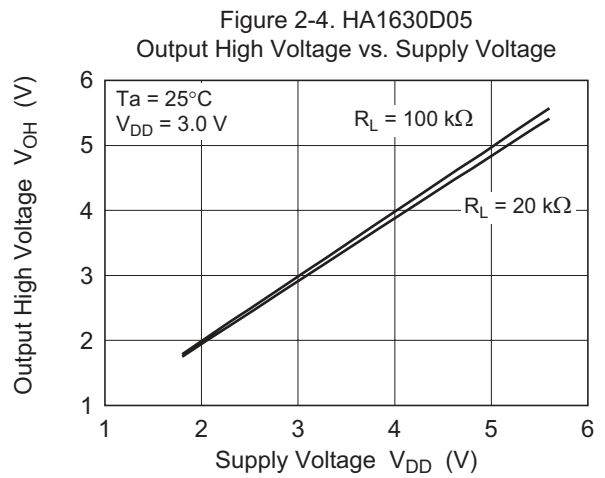
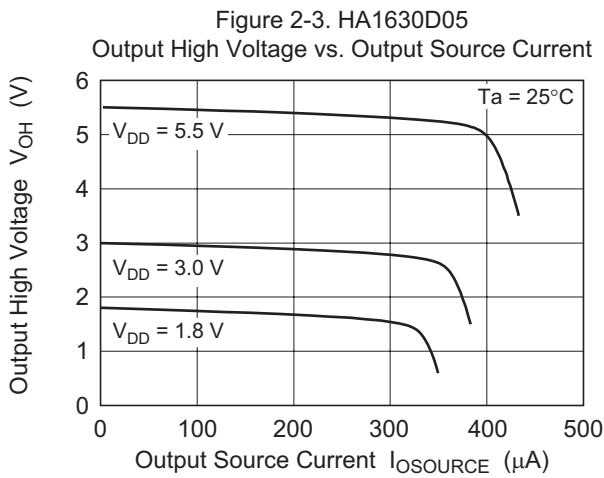
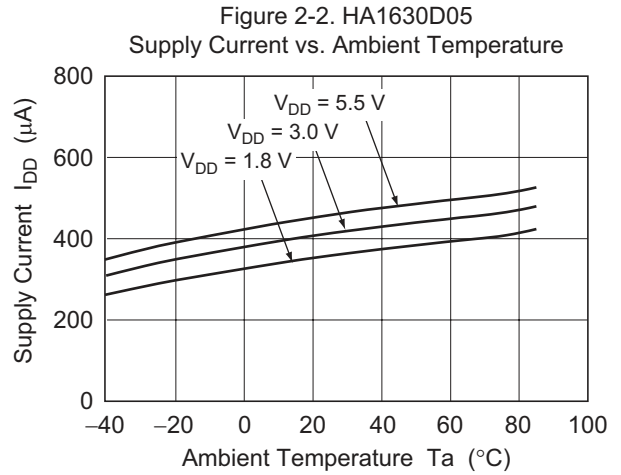
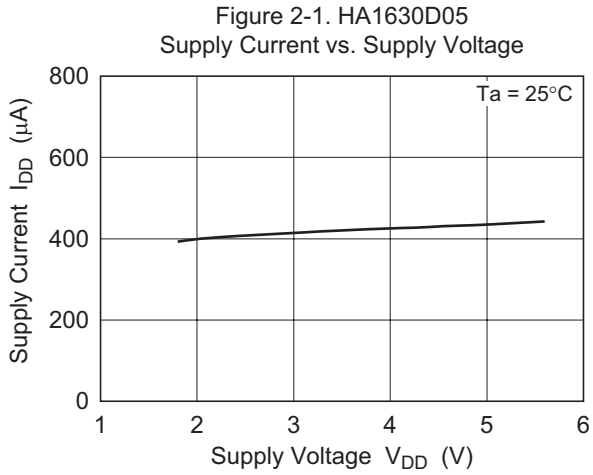

Figure 1-25. HA1630D04
Channel Separation vs. Frequency



Main Characteristics (HA1630D05)



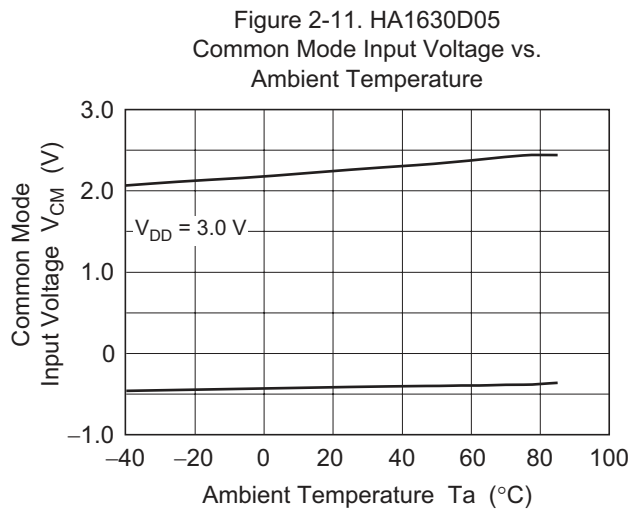
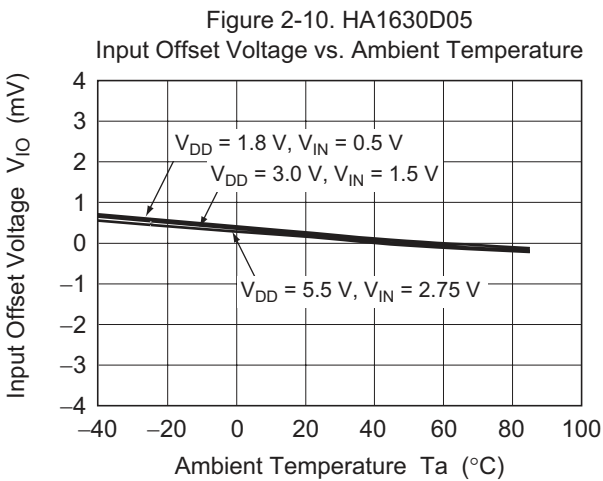
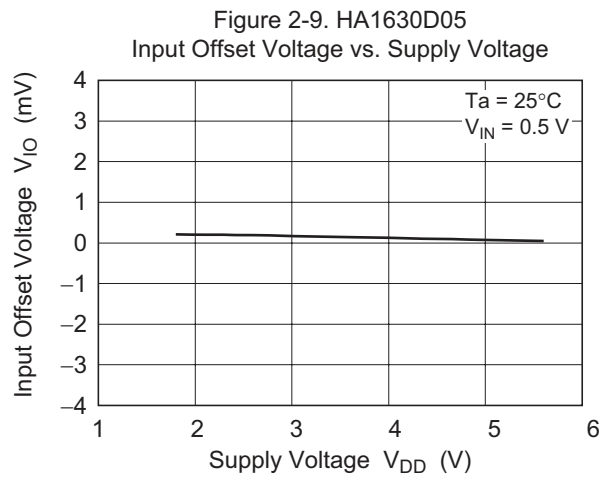
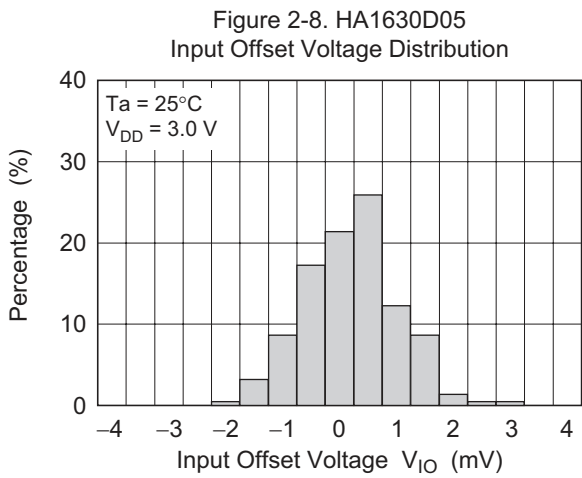
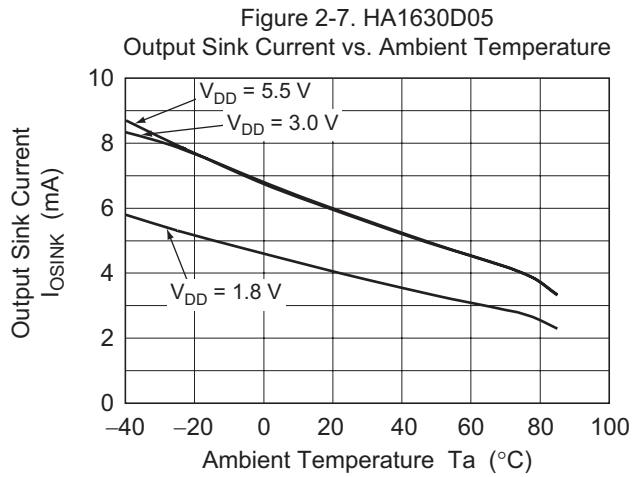
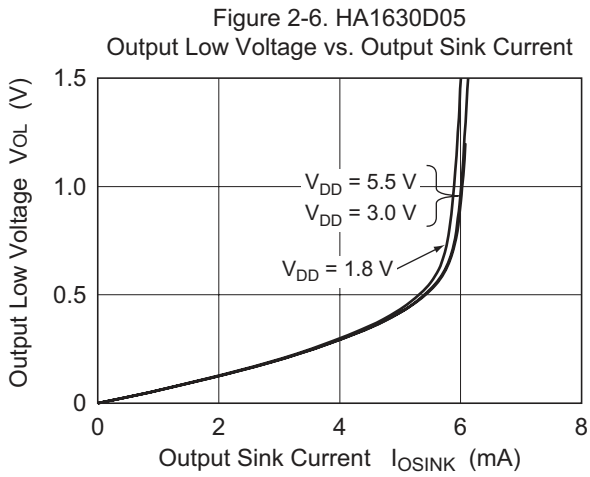

Figure 2-12. HA1630D05
Power Supply Rejection Ratio vs. Frequency

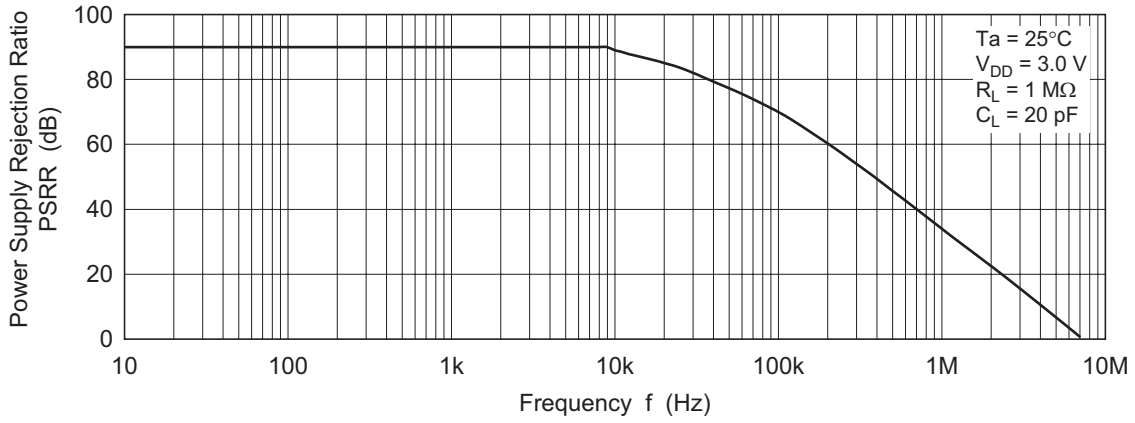

Figure 2-13. HA1630D05
Common Mode Rejection Ratio vs. Frequency

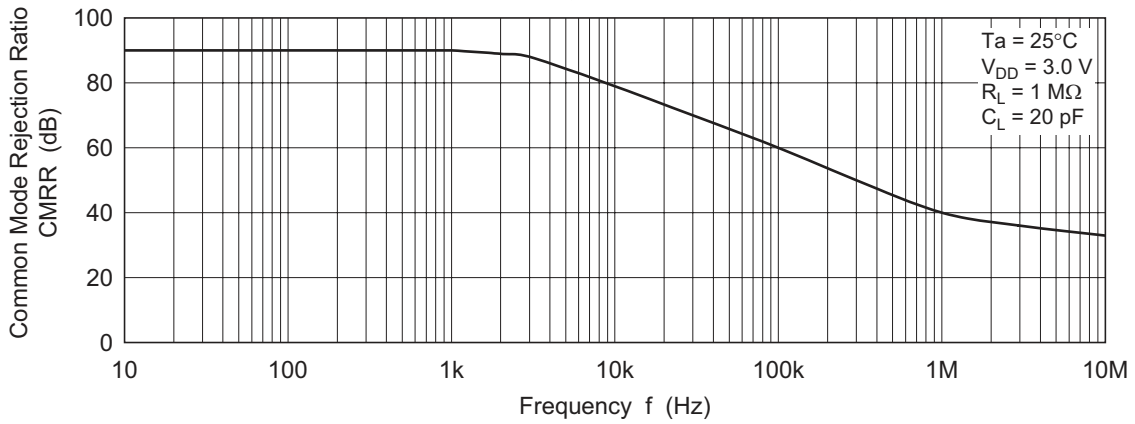
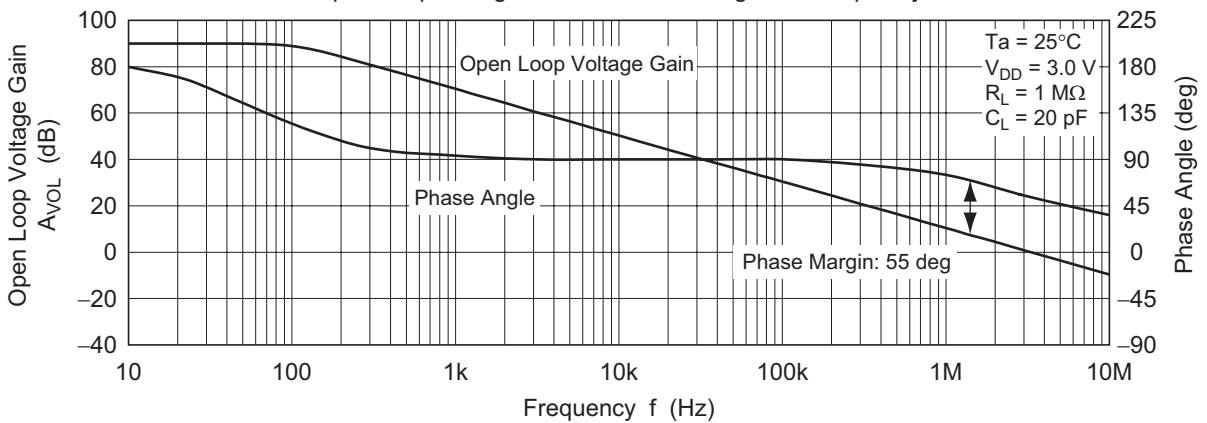

Figure 2-14. HA1630D05
Open Loop Voltage Gain and Phase Angle vs. Frequency



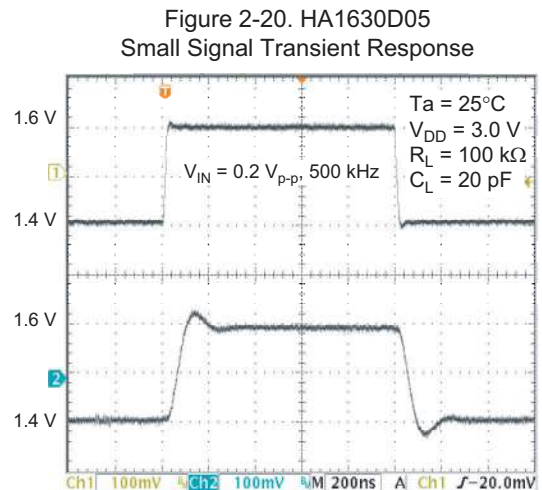
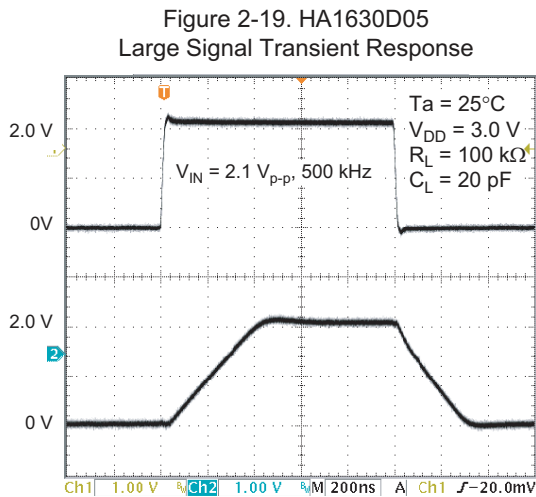
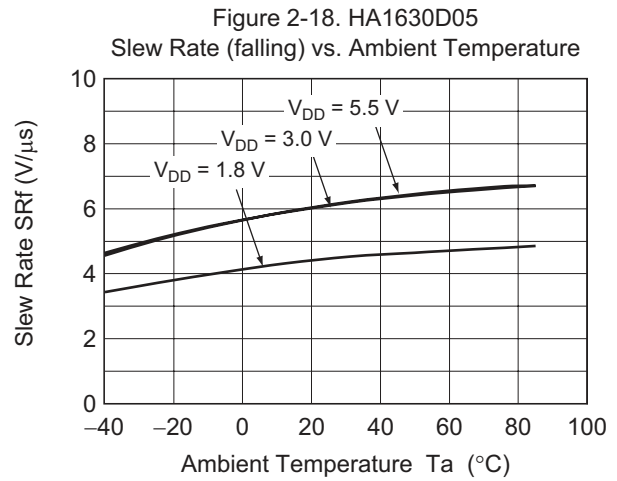
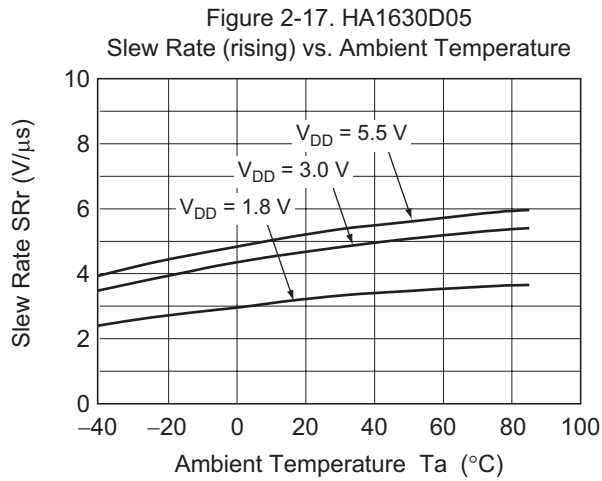
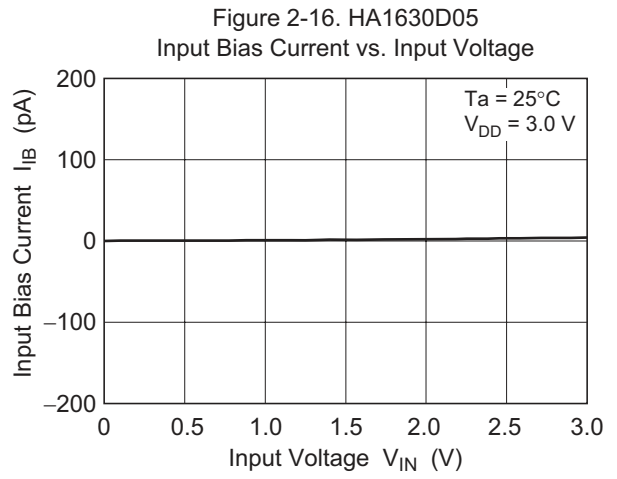
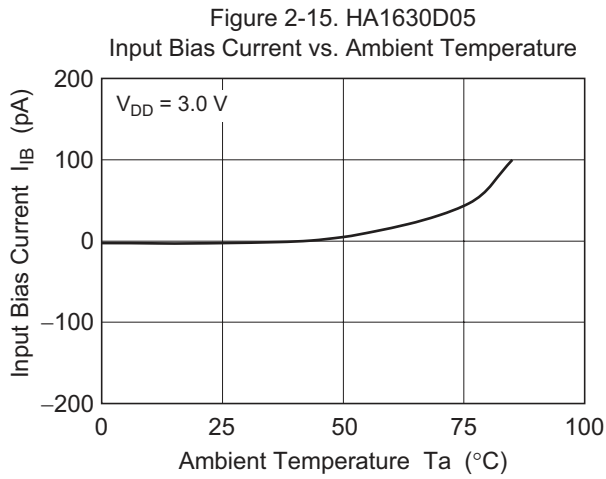

Figure 2-21. HA1630D05
Total Harmonic Distortion + Noise vs.
Output Voltage p-p

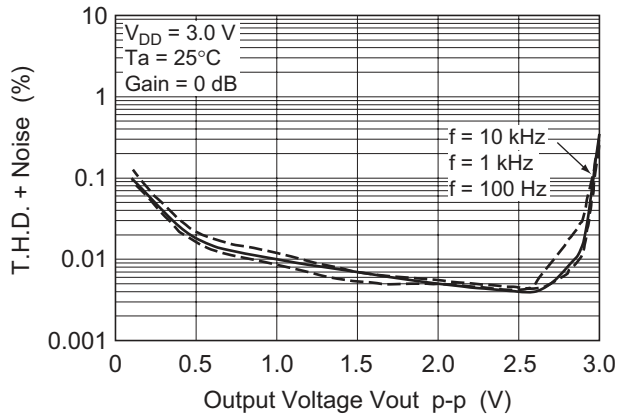

Figure 2-22. HA1630D05
Total Harmonic Distortion + Noise vs.
Output Voltage p-p

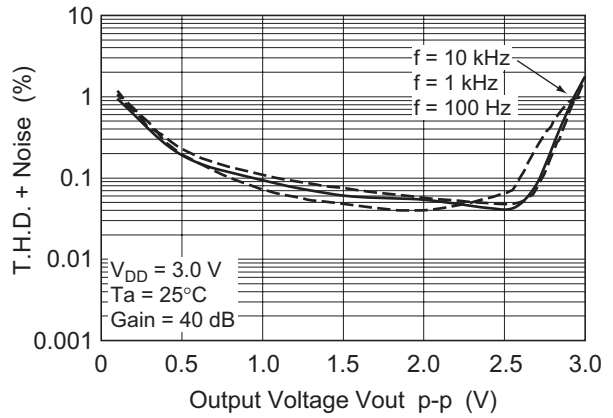

Figure 2-23. HA1630D05
Voltage Output p-p vs. Frequency

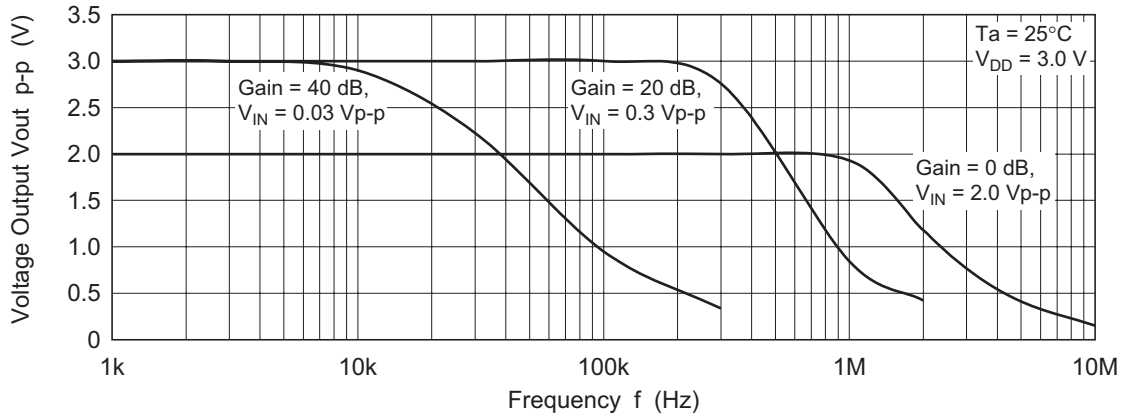

Figure 2-24. HA1630D05
Voltage Noise Density vs. Frequency

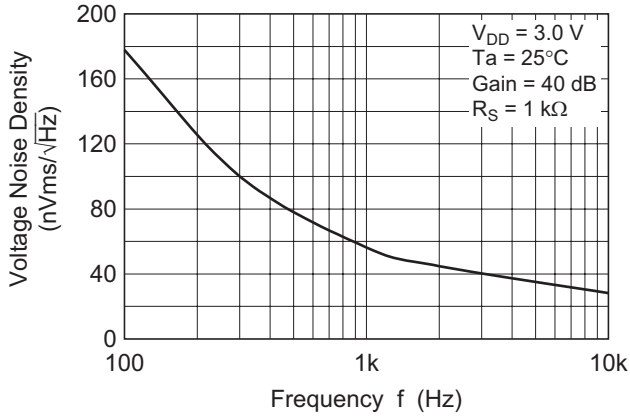
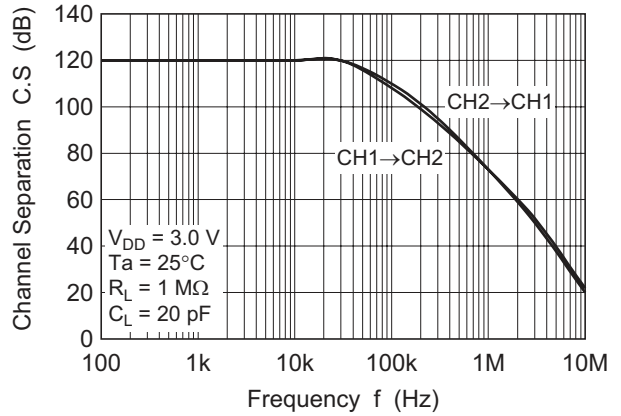
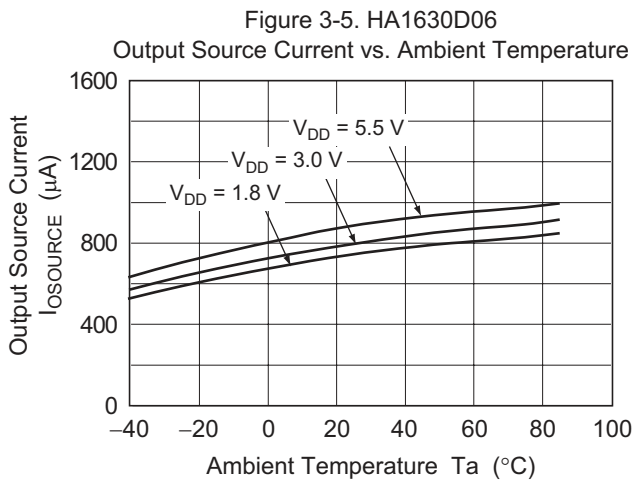
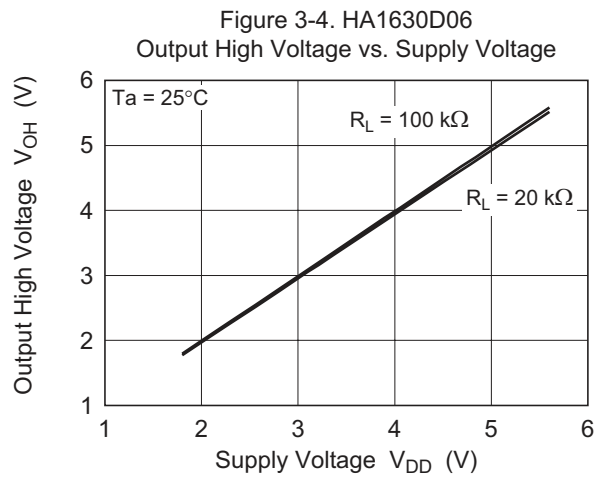
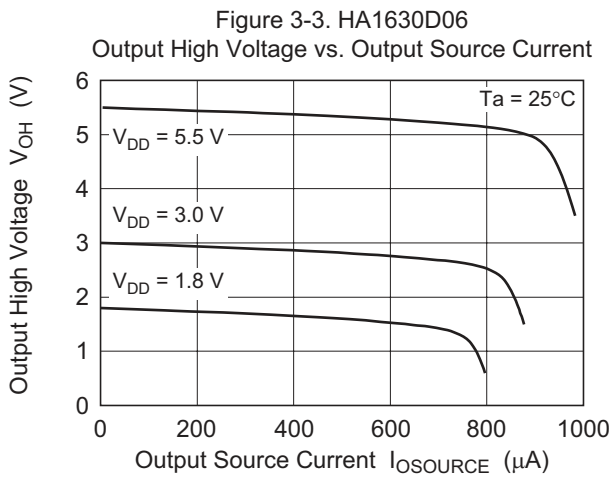
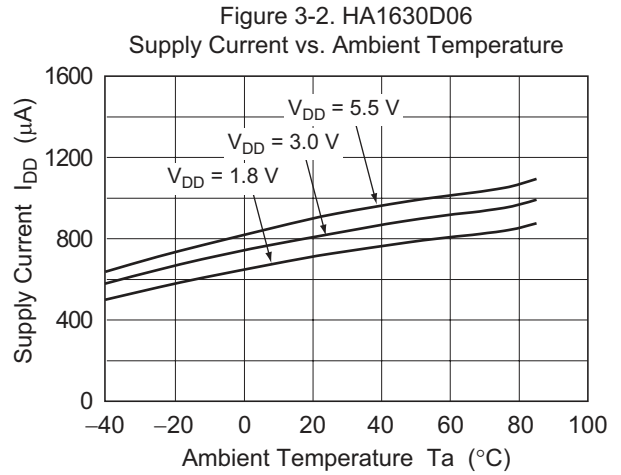
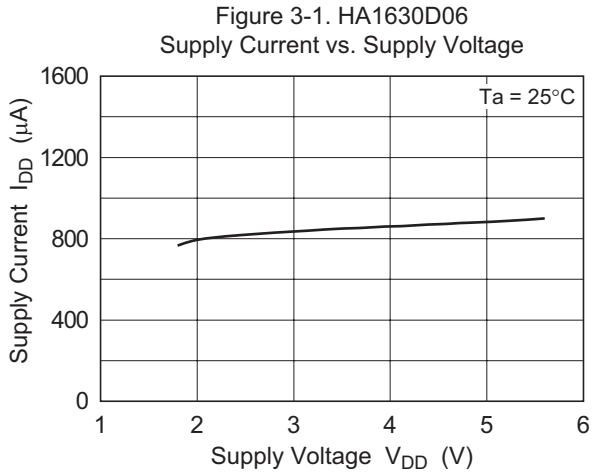

Figure 2-25. HA1630D05
Channel Separation vs. Frequency



Main Characteristics (HA1630D06)



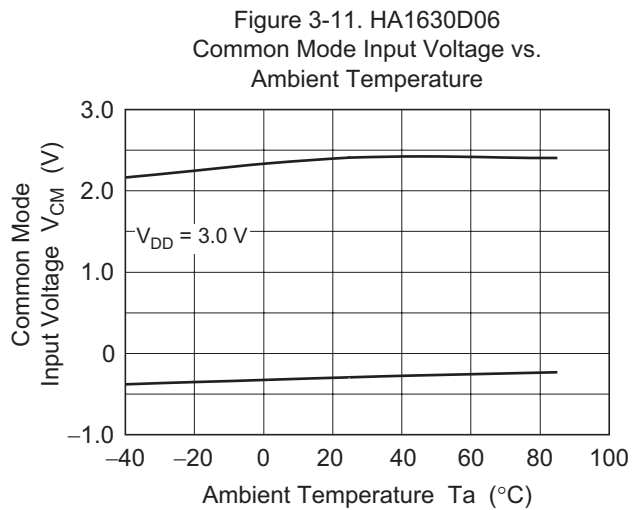
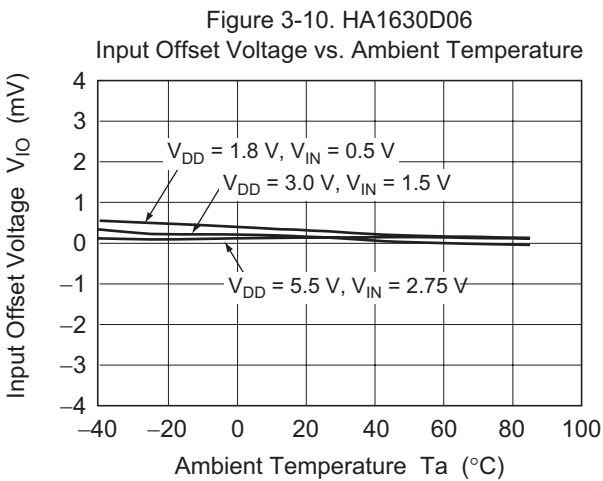
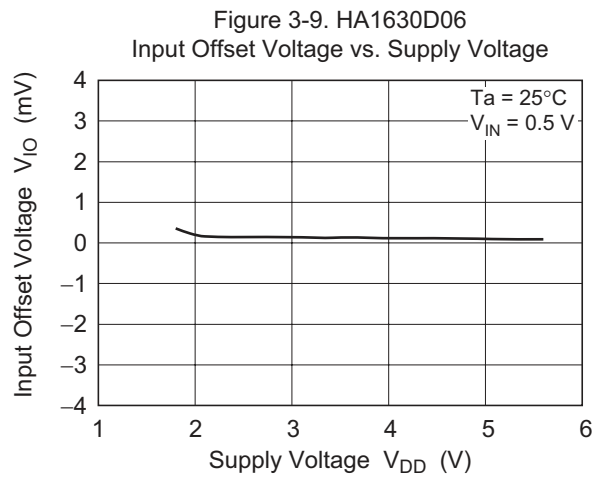
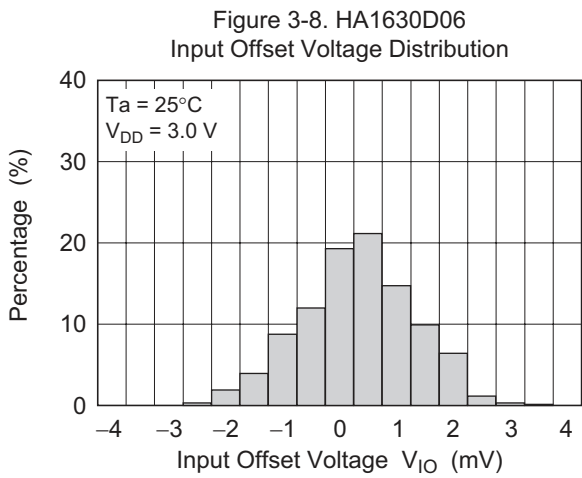
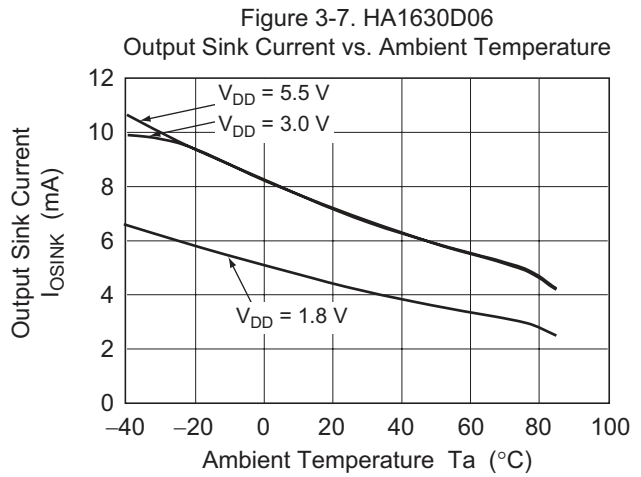
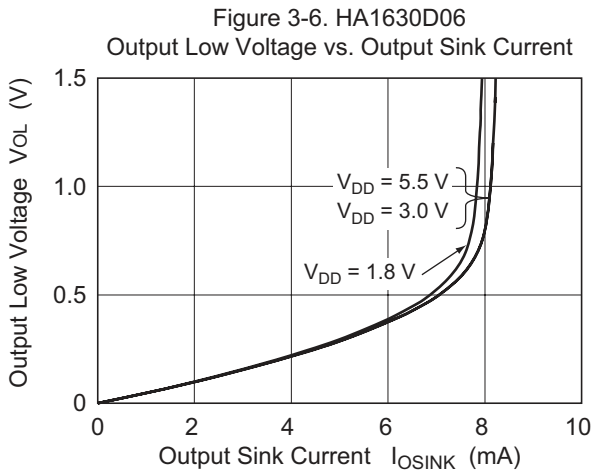

Figure 3-12. HA1630D06
Power Supply Rejection Ratio vs. Frequency

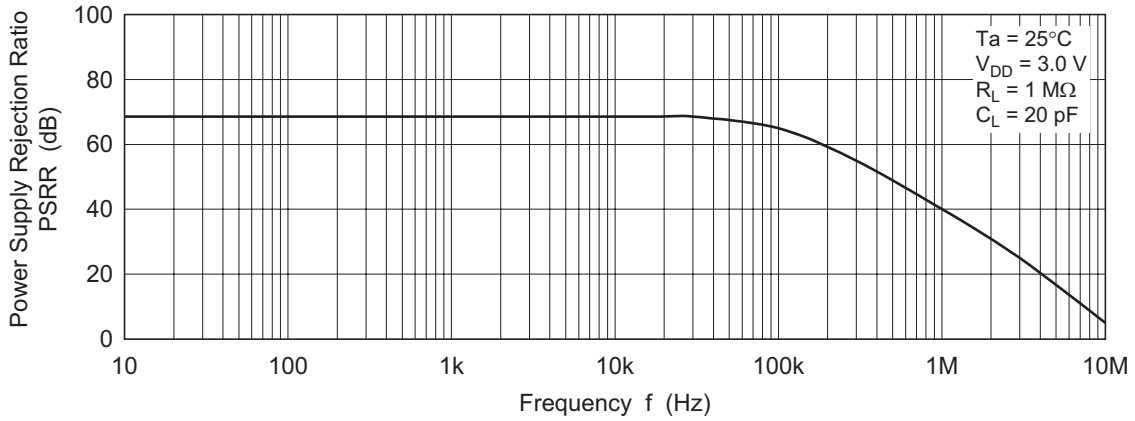

Figure 3-13. HA1630D06
Common Mode Rejection Ratio vs. Frequency

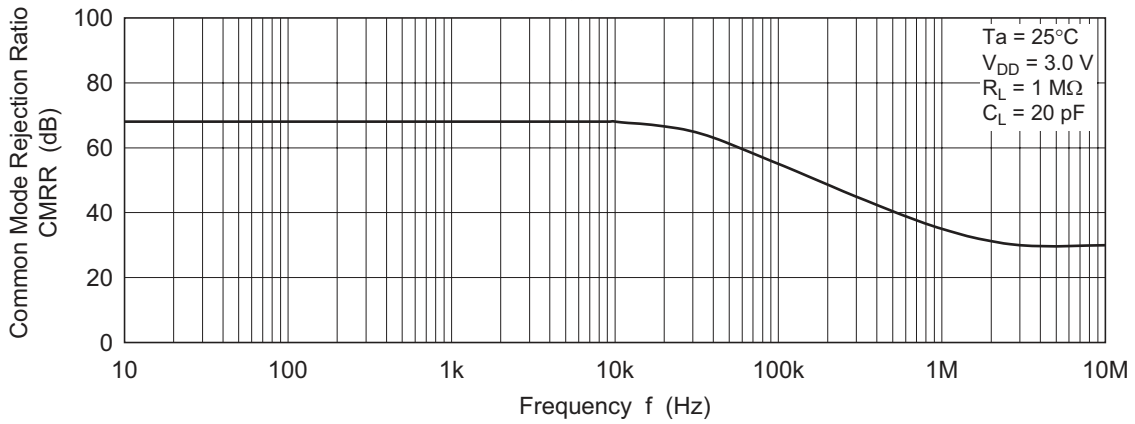
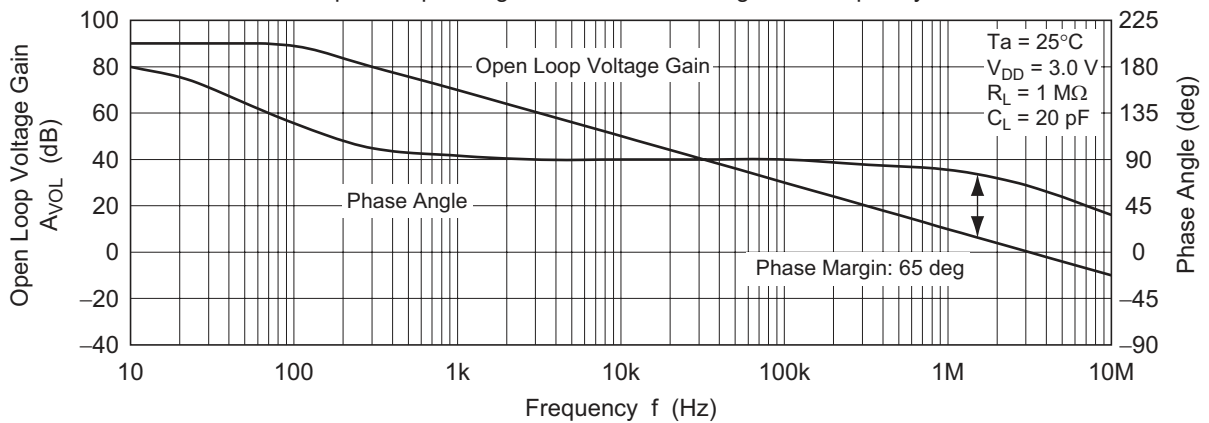

Figure 3-14. HA1630D06
Open Loop Voltage Gain and Phase Angle vs. Frequency



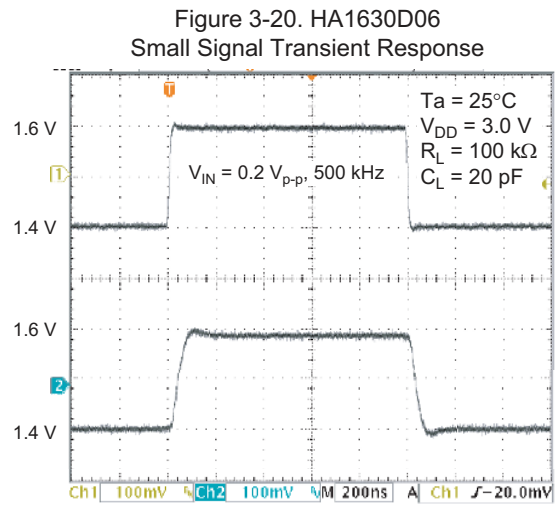
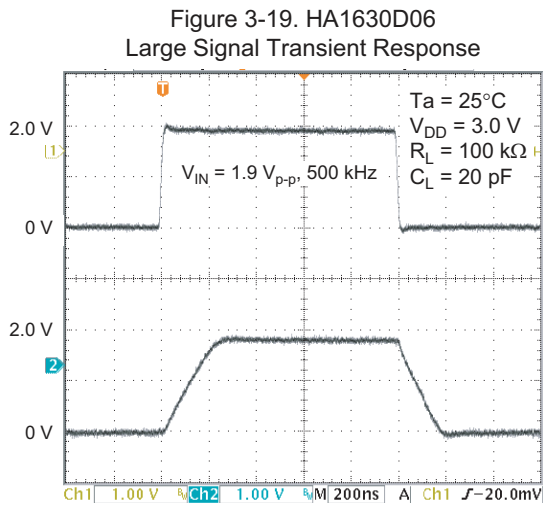
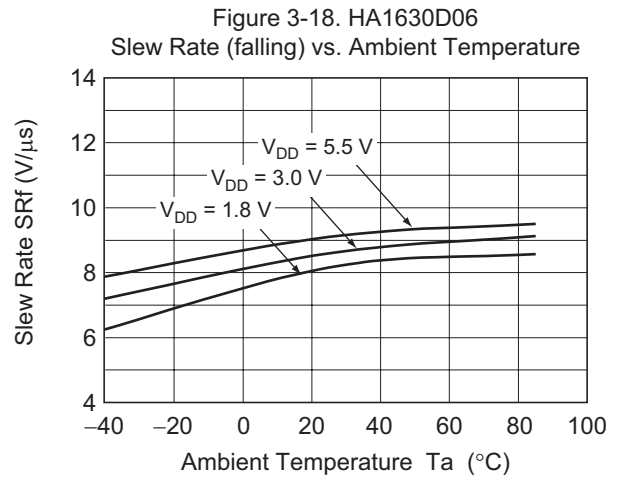
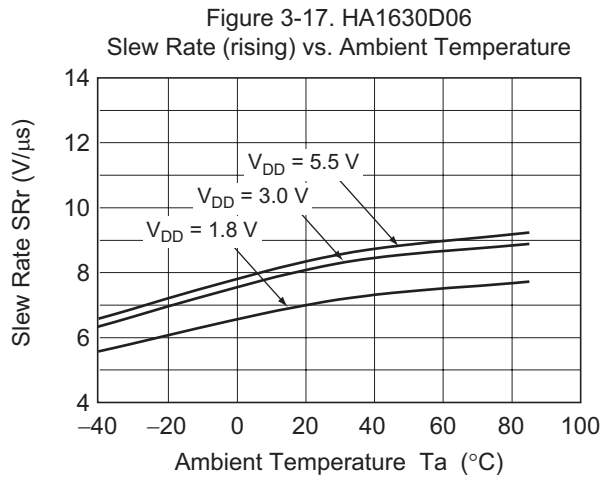
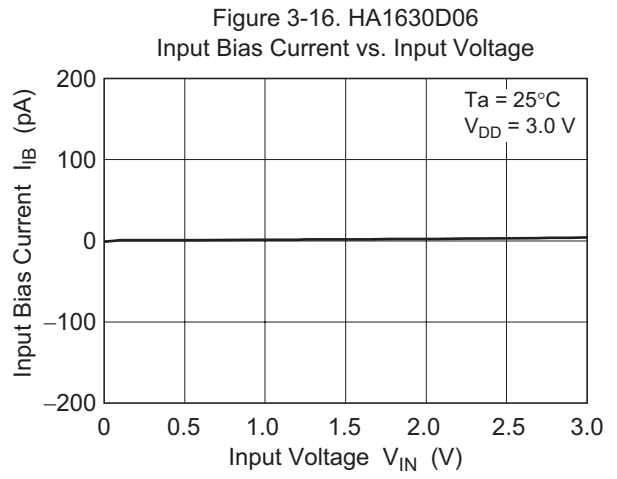
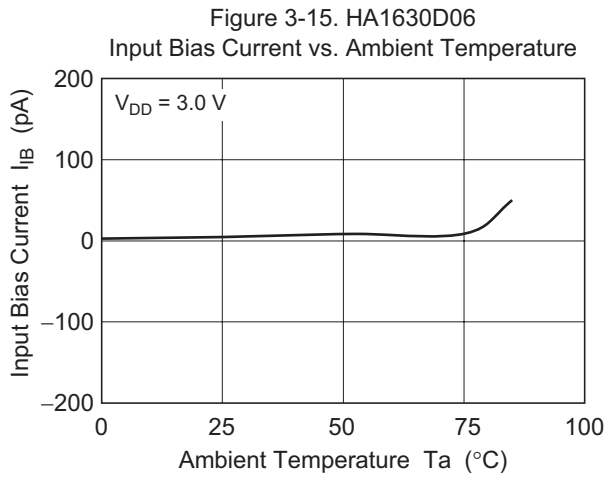

Figure 3-21. HA1630D06
Total Harmonic Distortion + Noise vs.
Output Voltage p-p

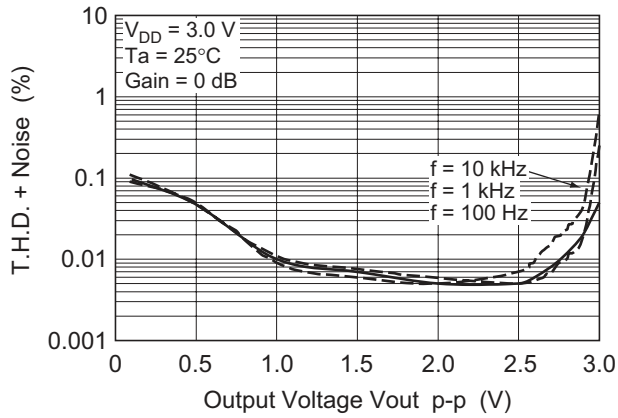

Figure 3-22. HA1630D06
Total Harmonic Distortion + Noise vs.
Output Voltage p-p

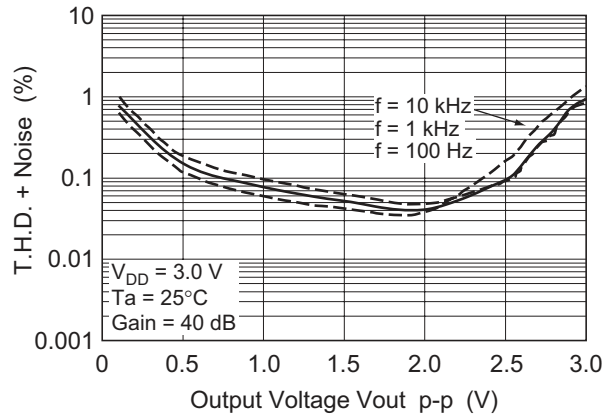

Figure 3-23. HA1630D06
Voltage Output p-p vs. Frequency

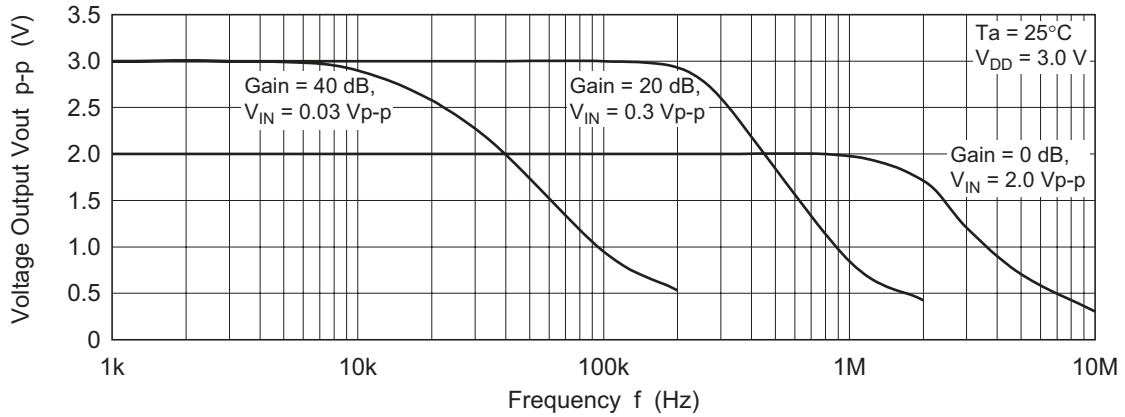

Figure 3-24. HA1630D06
Voltage Noise Density vs. Frequency

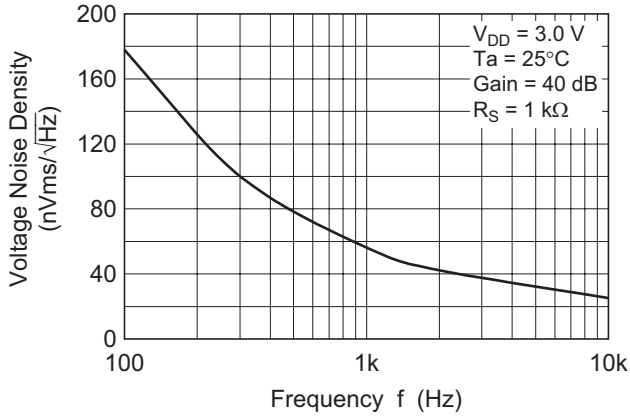
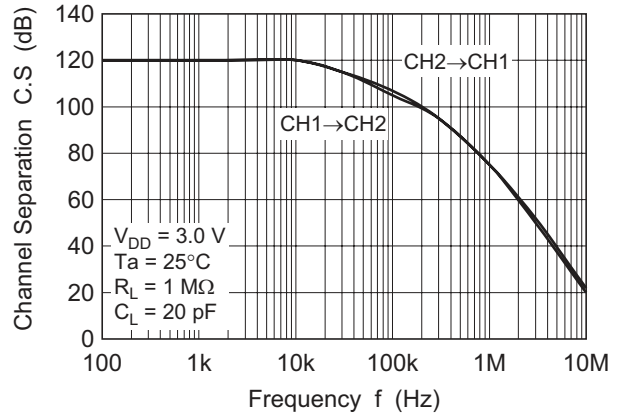
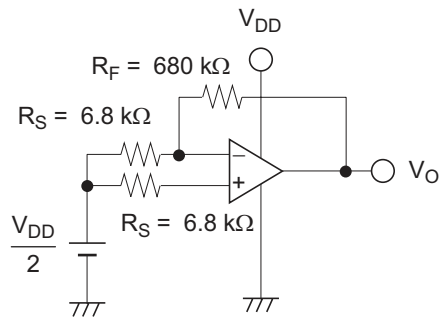

Figure 3-25. HA1630D06
Channel Separation vs. Frequency



Test Circuits

1. Power Supply Rejection Ratio, PSRR & Voltage Offset, V_{IO}



$$V_{IO} = \left(V_O - \frac{V_{DD}}{2} \right) \times \frac{R_S}{R_S + R_F}$$

PSRR

$$PSRR = -20 \log \left(\left| \frac{V_{DD1} - V_{DD2}}{V_{O1} - V_{O2}} \right| \times \frac{R_S}{R_S + R_F} \right)$$

Measure V_O corresponding to $V_{DD1} = 2.95 \text{ V}$ and $V_{DD2} = 3.05 \text{ V}$

2. Supply Current, I_{DD}

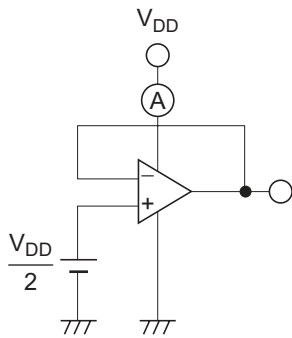

3. Input Bias Current, I_B

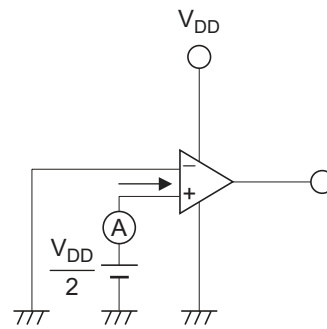

4. Output High Voltage, V_{OH}

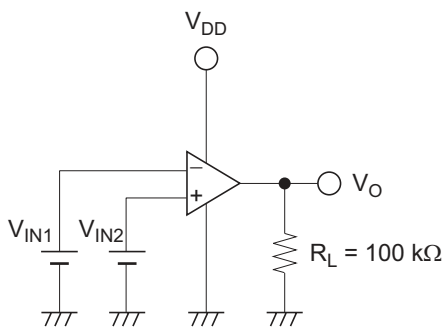

$$\begin{aligned} V_{OH} \\ V_{IN1} &= V_{DD} / 2 - 0.05 \text{ V} \\ V_{IN2} &= V_{DD} / 2 + 0.05 \text{ V} \end{aligned}$$

5. Output Low Voltage, V_{OL}

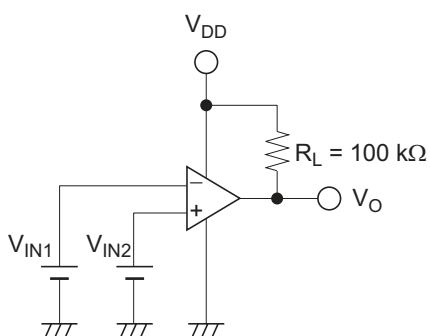

$$\begin{aligned} V_{OL} \\ V_{IN1} &= V_{DD} / 2 + 0.05 \text{ V} \\ V_{IN2} &= V_{DD} / 2 - 0.05 \text{ V} \end{aligned}$$

6. Output Source Current, $I_{OSOURCE}$ & Output Sink Current, I_{OSINK}

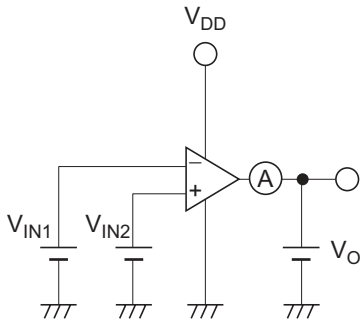

$I_{OSOURCE}$

$$V_O = V_{DD} - 0.5 \text{ V}$$

$$V_{IN1} = V_{DD} / 2 - 0.05 \text{ V}$$

$$V_{IN2} = V_{DD} / 2 + 0.05 \text{ V}$$

I_{OSINK}

$$V_O = + 0.5 \text{ V}$$

$$V_{IN1} = V_{DD} / 2 + 0.05 \text{ V}$$

$$V_{IN2} = V_{DD} / 2 - 0.05 \text{ V}$$

7. Common Mode Input Voltage, V_{CM} & Common Mode Rejection Ratio, CMRR

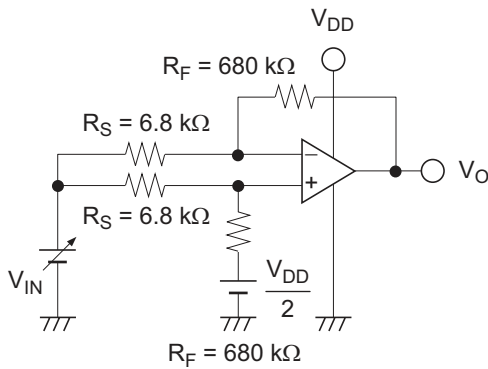

CMRR

$$CMRR = -20 \log \left(\left| \frac{V_{IN1} - V_{IN2}}{V_{O1} - V_{O2}} \right| \times \frac{R_S}{R_S + R_F} \right)$$

Measure V_O corresponding to $V_{IN1} = 1.45 \text{ V}$ and $V_{IN2} = 1.55 \text{ V}$

8. Total Harmonic Distortion, THD

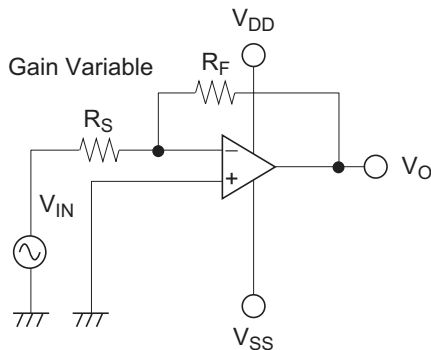

THD

Gain Variable
 $R_F / R_S = 20 \log (100 \text{ k}\Omega / 1 \text{ k}\Omega) = 40 \text{ dB}$
 $R_F / R_S = 20 \log (100 \text{ k}\Omega / 100 \text{ k}\Omega) = 0 \text{ dB}$
 freq = 100 Hz, 1 kHz, 10 kHz
 30 kHz LPF ON

9. Slew Rate, SR

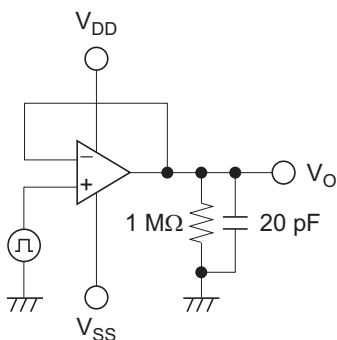

10. Gain, A_V & Phase, GBW

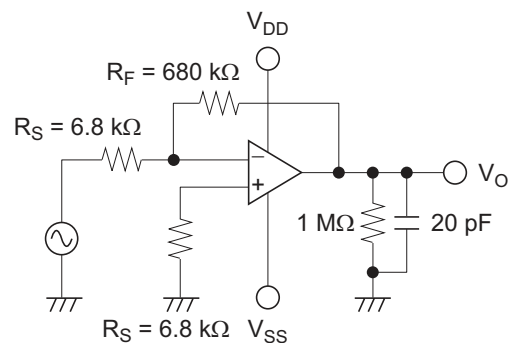

Package Dimensions

JEITA Package Code	RENEASAS Code	Previous Code	MASS[Typ.]
P-TSSOP8-4.4x3-0.65	PTSP0008JC-B	TTP-8DAV	0.034g

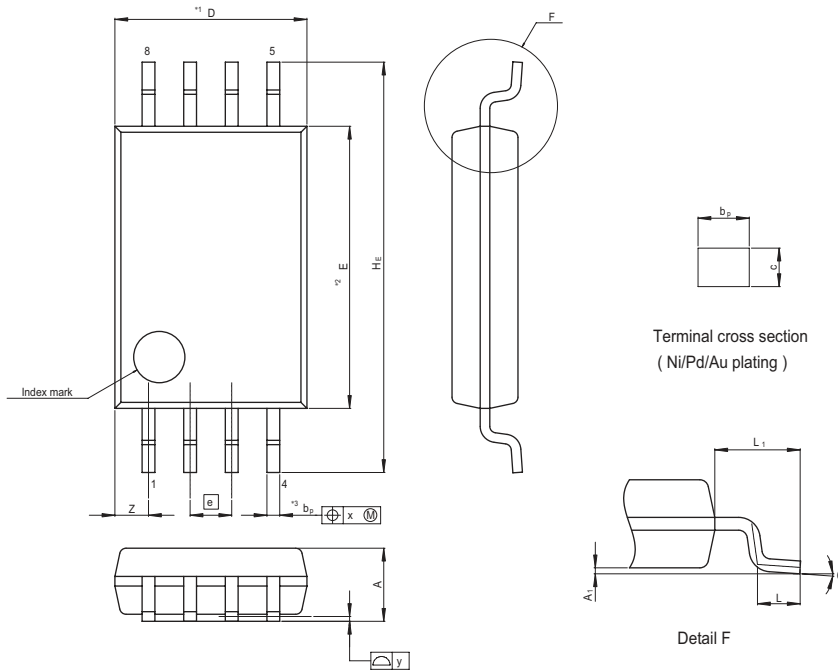

NOTE)
 1. DIMENSIONS*1 (Nom)*AND*2*
 DO NOT INCLUDE MOLD FLASH.
 2. DIMENSION*3*DOES NOT
 INCLUDE TRIM OFFSET.

Reference Symbol	Dimension in Millimeters		
	Min	Nom	Max
D	—	3.00	3.30
E	—	4.40	—
A ₂	—	—	—
A ₁	0.03	0.07	0.10
A	—	—	1.10
b _P	0.15	0.20	0.25
b ₁	—	—	—
c	0.10	0.15	0.20
c ₁	—	—	—
θ	0°	—	8°
H _E	6.20	6.40	6.60
e	—	0.65	—
x	—	—	0.13
y	—	—	0.10
Z	—	—	0.805
L	0.40	0.50	0.60
L ₁	—	1.00	—

Package Name	JEITA Package Code	RENEASAS Code	Previous Code	MASS[Typ.]
MMPAK-8	P-LSOP8-2.8 x 2.95 - 0.65	PLSP0008JC-A	—	0.02 g

Unit: mm

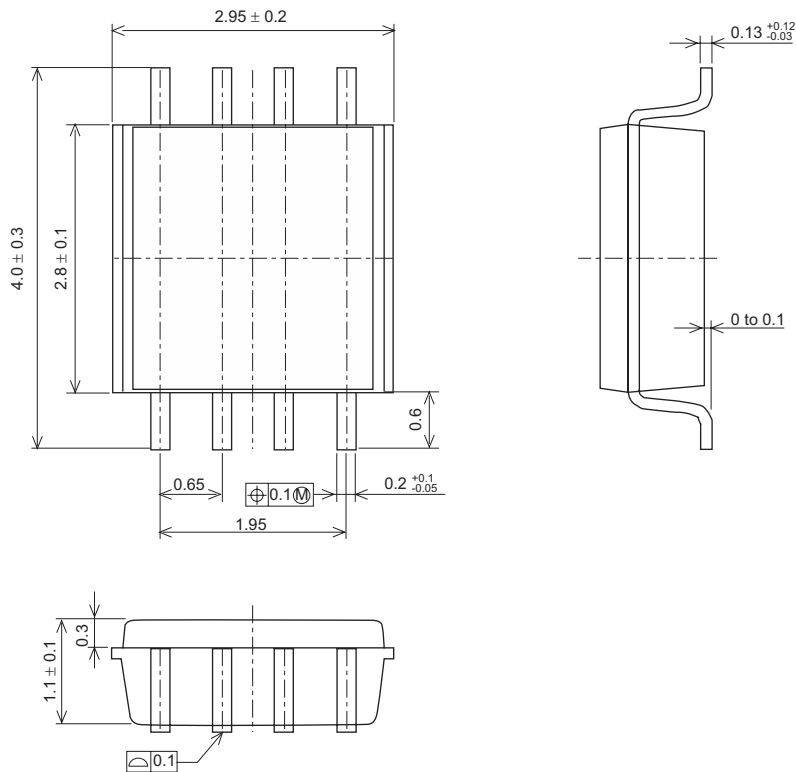

Taping & Reel Specification

[Taping]

Package Code	W	P	Ao	Bo	Ko	E	F	D1	Maximum Storage No.
TSSOP-8	12	8	6.9	3.6	1.7	1.75	5.5	1.5	3,000 pcs/reel
MMPAK-8	12	4.0	3.15	4.35	—	—	5.5	1.05	3,000 pcs/reel

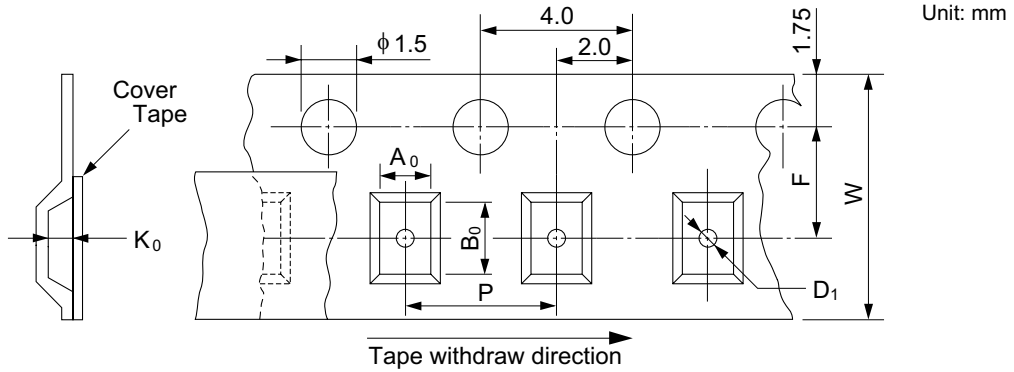

[Reel]

Package	Tape width	W1	W2	A
TSSOP-8	12	17.4	13.4	330
MMPAK-8	12	17.0	13.0	178

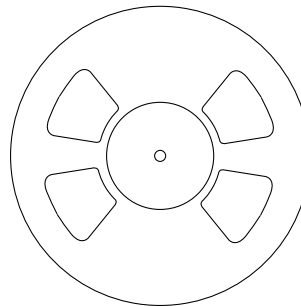

[Ordering Information]

Ordering Unit
3,000 pcs

Mark Indication

TSSOP-8

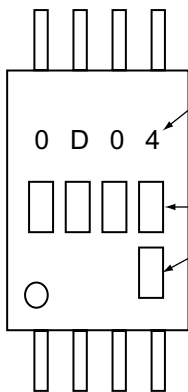

Product Name
 0D04: HA1630D04
 0D05: HA1630D05
 0D06: HA1630D06

Trace Code

MMPAK-8

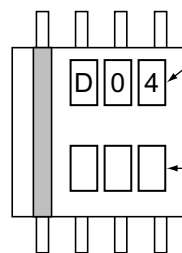

Product Name
 D04: HA1630D04
 D05: HA1630D05
 D06: HA1630D06

Trace Code

Notice

1. Descriptions of circuits, software and other related information in this document are provided only to illustrate the operation of semiconductor products and application examples. You are fully responsible for the incorporation or any other use of the circuits, software, and information in the design of your product or system. Renesas Electronics disclaims any and all liability for any losses and damages incurred by you or third parties arising from the use of these circuits, software, or information.
2. Renesas Electronics hereby expressly disclaims any warranties against and liability for infringement or any other disputes involving patents, copyrights, or other intellectual property rights of third parties, by or arising from the use of Renesas Electronics products or technical information described in this document, including but not limited to, the product data, drawing, chart, program, algorithm, application examples.
3. No license, express, implied or otherwise, is granted hereby under any patents, copyrights or other intellectual property rights of Renesas Electronics or others.
4. You shall not alter, modify, copy, or otherwise misappropriate any Renesas Electronics product, whether in whole or in part. Renesas Electronics disclaims any and all liability for any losses or damages incurred by you or third parties arising from such alteration, modification, copy or otherwise misappropriation of Renesas Electronics products.
5. Renesas Electronics products are classified according to the following two quality grades: "Standard" and "High Quality". The intended applications for each Renesas Electronics product depends on the product's quality grade, as indicated below.
"Standard": Computers; office equipment; communications equipment; test and measurement equipment; audio and visual equipment; home electronic appliances; machine tools; personal electronic equipment; and industrial robots etc.
"High Quality": Transportation equipment (automobiles, trains, ships, etc.); traffic control (traffic lights); large-scale communication equipment; key financial terminal systems; safety control equipment; etc.
Renesas Electronics products are neither intended nor authorized for use in products or systems that may pose a direct threat to human life or bodily injury (artificial life support devices or systems, surgical implantations etc.), or may cause serious property damages (space and undersea repeaters; nuclear power control systems; aircraft control systems; key plant systems; military equipment; etc.). Renesas Electronics disclaims any and all liability for any damages or losses incurred by you or third parties arising from the use of any Renesas Electronics product for which the product is not intended by Renesas Electronics.
6. When using the Renesas Electronics products, refer to the latest product information (data sheets, user's manuals, application notes, "General Notes for Handling and Using Semiconductor Devices" in the reliability handbook, etc.), and ensure that usage conditions are within the ranges specified by Renesas Electronics with respect to maximum ratings, operating power supply voltage range, heat radiation characteristics, installation, etc. Renesas Electronics disclaims any and all liability for any malfunctions or failure or accident arising out of the use of Renesas Electronics products beyond such specified ranges.
7. Although Renesas Electronics endeavors to improve the quality and reliability of Renesas Electronics products, semiconductor products have specific characteristics such as the occurrence of failure at a certain rate and malfunctions under certain use conditions. Further, Renesas Electronics products are not subject to radiation resistance design. Please ensure to implement safety measures to guard them against the possibility of bodily injury, injury or damage caused by fire, and social damage in the event of failure or malfunction of Renesas Electronics products, such as safety design for hardware and software including but not limited to redundancy, fire control and malfunction prevention, appropriate treatment for aging degradation or any other appropriate measures by your own responsibility as warranty for your products/system. Because the evaluation of microcomputer software alone is very difficult and not practical, please evaluate the safety of the final products or systems manufactured by you.
8. Please contact a Renesas Electronics sales office for details as to environmental matters such as the environmental compatibility of each Renesas Electronics product. Please investigate applicable laws and regulations that regulate the inclusion or use of controlled substances, including without limitation, the EU RoHS Directive carefully and sufficiently and use Renesas Electronics products in compliance with all these applicable laws and regulations. Renesas Electronics disclaims any and all liability for damages or losses occurring as a result of your noncompliance with applicable laws and regulations.
9. Renesas Electronics products and technologies shall not be used for or incorporated into any products or systems whose manufacture, use, or sale is prohibited under any applicable domestic or foreign laws or regulations. You shall not use Renesas Electronics products or technologies for (1) any purpose relating to the development, design, manufacture, use, stockpiling, etc., of weapons of mass destruction, such as nuclear weapons, chemical weapons, or biological weapons, or missiles (including unmanned aerial vehicles (UAVs)) for delivering such weapons, (2) any purpose relating to the development, design, manufacture, or use of conventional weapons, or (3) any other purpose of disturbing international peace and security, and you shall not sell, export, lease, transfer, or release Renesas Electronics products or technologies to any third party whether directly or indirectly with knowledge or reason to know that the third party or any other party will engage in the activities described above. When exporting, selling, transferring, etc., Renesas Electronics products or technologies, you shall comply with any applicable export control laws and regulations promulgated and administered by the governments of the countries asserting jurisdiction over the parties or transactions.
10. Please acknowledge and agree that you shall bear all the losses and damages which are incurred from the misuse or violation of the terms and conditions described in this document, including this notice, and hold Renesas Electronics harmless, if such misuse or violation results from your resale or making Renesas Electronics products available any third party.
11. This document shall not be reprinted, reproduced or duplicated in any form, in whole or in part, without prior written consent of Renesas Electronics.
12. Please contact a Renesas Electronics sales office if you have any questions regarding the information contained in this document or Renesas Electronics products.
(Note 1) "Renesas Electronics" as used in this document means Renesas Electronics Corporation and also includes its majority-owned subsidiaries.
(Note 2) "Renesas Electronics product(s)" means any product developed or manufactured by or for Renesas Electronics.

以下“注意事项”为从英语原稿翻译的中文译文，仅作为参考译文，英文版的“Notice”具有正式效力。

注意事项

1. 本文件中所记载的关于电路、软件和其他相关信息仅用于说明半导体产品的操作和应用实例。用户如在产品或系统设计中应用本文件中的电路、软件和相关信息或将此等内容用于其他目的时，请自行负责。对于用户或第三方因使用上述电路、软件或信息而遭受的任何损失和损害，瑞萨电子概不承担任何责任。
2. 瑞萨电子在此明确声明，对于因使用瑞萨电子产品或本文件中所述技术信息（包括但不限于产品数据、图、表、程序、算法、应用实例）而造成的与第三方专利、版权或其他知识产权相关的侵权或其他争议，瑞萨电子不作任何保证并概不承担任何责任。
3. 本文件所记载的内容不应视为对瑞萨电子或其他人所有的专利、版权或其他知识产权作出任何明示、默示或其它方式的许可及授权。
4. 用户不得更改、修改、复制或其他方式部分或全部地非法使用瑞萨电子的任何产品。对于用户或第三方因上述更改、修改、复制或以其他方式非法使用瑞萨电子产品的行为而遭受的任何损失或损害，瑞萨电子概不承担任何责任。
5. 瑞萨电子产品根据其质量等级分为两个等级：“标准等级”和“高质量等级”。每种瑞萨电子产品的预期用途均取决于产品的质量等级，如下所示：
标准等级：计算机、办公设备、通讯设备、测试和测量设备、视听设备、家用电器、机械工具、个人电子设备以及工业机器人等。
高质量等级：运输设备（汽车、火车、轮船等）、交通控制系统（交通信号灯）、大型通讯设备、关键金融终端系统、安全控制设备等。
瑞萨电子产品无意用于且未被授权用于可能对人类生命造成直接威胁的产品或系统以及可能造成人身伤害的产品或系统（人工生命维持装置或系统、植入于体内的装置等）中，或者可能造成重大财产损失的产品或系统（太空和海底潜航器、核能控制系统、飞机控制系统、关键装置系统、军用设备等）中。对于用户或第三方因将瑞萨电子产品用于其设计用途之外而遭受的任何损害或损失，瑞萨电子不承担任何责任。
6. 使用瑞萨电子产品时，请参阅最新产品信息（数据表、使用说明书、应用指南、可靠性手册中的“半导体元件处理和使用一般注意事项”等），并确保使用条件在瑞萨电子指定的最大额定值、电源工作电压范围、热辐射特性、安装条件等范围内使用。对于在上述指定范围之外使用瑞萨电子产品而产生的任何故障、失效或事故，瑞萨电子不承担任何责任。
7. 虽然瑞萨电子一直致力于提高瑞萨电子产品的质量和可靠性，但是，半导体产品有其自身的具体特性，如一定的故障发生率以及在某些使用条件下会发生故障等。此外，瑞萨电子产品均未进行防辐射设计。所以请采取安全防护措施，以避免当瑞萨电子产品在发生失效或故障而造成火灾时导致人身伤害、受伤或损害以及社会损害，例如进行软硬件安全设计（包括但不限于冗余设计、防火控制以及故障预防等）、适当的老化处理或者由用户自行承担对产品/系统进行保修的其他适当措施等。由于对微软件单独进行评估非常困难且并不实际，所以请用户自行对最终产品或系统进行安全评估。
8. 关于环境保护方面的详细内容，例如每种瑞萨电子产品的环境兼容性等，请与瑞萨电子的营业部门联系。请仔细并充分查阅对管制物质的使用或含量进行管理的所有适用法律法规（包括但不限于《欧盟RoHS指令》），并在使用瑞萨电子产品时遵守所有适用法律法规。对于因用户未遵守相应法律法规而导致的损害或损失，瑞萨电子不承担任何责任。
9. 不可将瑞萨电子产品和技术用于或者嵌入日本国内或海外相应的法律法例所禁止生产、使用及销售的任何产品或系统中。也不可将瑞萨电子产品或技术用于(1)与大规模杀伤性武器（例如核武器、化学武器、生物武器或运这些武器的导弹，包括无人飞行器(UAV)的开发、设计、制造、使用、存储等相关的任何目的；(2)与常规武器的开发、设计、制造或使用相关的任何目的；(3)扰乱国际和平与安全的任何其他目的，并且不可向任何第三国销售、出口、租赁、转让、或让与瑞萨电子产品或技术，无论直接或间接知悉或者有理由知悉该第三国或任何其他方将从事上述活动。对瑞萨电子产品或技术进行出口、销售、转让等时，必须遵守对于各方或文易主主张司法管辖权的国家/地区政府公布和管理的任何适用出口管制法律法例。
10. 请悉并同意，用户将承担由于不当使用或违反本文件（包括本注意事项）中所述条款与条件而导致的任何损失和损害，并且如果此等不当使用或违反是因为用户将瑞萨电子产品转售或提供给任何第三方使用而致，则用户必须使瑞萨电子不受损失。
11. 在事先未得到瑞萨电子书面认可的情况下，不得以任何形式部分或全部再版、转载或复制本文件。
12. 如果对本文件所记载的信息或瑞萨电子产品有任何疑问，请向瑞萨电子的营业部门咨询。
(注1) 瑞萨电子：在本文件中指瑞萨电子株式会社及其控股子公司。
(注2) 瑞萨电子产品：指瑞萨电子开发或生产的任何产品。

(Rev.3.0-1 November 2016)



SALES OFFICES

Renesas Electronics Corporation

<http://www.renesas.com>

Refer to "http://www.renesas.com/" for the latest and detailed information.

Renesas Electronics America Inc.
2801 Scott Boulevard Santa Clara, CA 95050-2549, U.S.A.
Tel: +1-408-588-6000, Fax: +1-408-588-6130

Renesas Electronics Canada Limited
9251 Yonge Street, Suite 8309 Richmond Hill, Ontario Canada L4C 9T3
Tel: +1-905-237-2004

Renesas Electronics Europe Limited
Dukes Meadow, Millboard Road, Bourne End, Buckinghamshire, SL8 5FH, U.K.
Tel: +44-1628-585-100, Fax: +44-1628-585-500

Renesas Electronics Europe GmbH
Arcadistraße 10, 40472 Düsseldorf, Germany
Tel: +49-211-6503-0, Fax: +49-211-6503-1327

Renesas Electronics (China) Co., Ltd.
Room 1709, Quantum Plaza, No.27 ZhichunLu Haizian District, Beijing 100191, P.R.China
Tel: +86-10-8235-1155, Fax: +86-10-8235-7679

Renesas Electronics (Shanghai) Co., Ltd.
Unit 301, Tower A, Central Towers, 555 Langao Road, Putuo District, Shanghai, P. R. China 200333
Tel: +86-21-2226-0888, Fax: +86-21-2226-0999

Renesas Electronics Hong Kong Limited
Unit 1601-1611, 16/F., Tower 2, Grand Century Place, 193 Prince Edward Road West, Mongkok, Kowloon, Hong Kong
Tel: +852-2265-6688, Fax: +852-2886-9022

Renesas Electronics Taiwan Co., Ltd.
13F, No. 363, Fu Shing North Road, Taipei 10543, Taiwan
Tel: +886-2-8175-9600, Fax: +886-2-8175-9670

Renesas Electronics Singapore Pte. Ltd.
80 Bendemeer Road, Unit #06-02 Hyflux Innovation Centre, Singapore 339949
Tel: +65-6213-0200, Fax: +65-6213-0300

Renesas Electronics Malaysia Sdn.Bhd.
Unit 1207, Block B, Menara Amcorp, Amcorp Trade Centre, No. 18, Jin Persiaran Barat, 46050 Petaling Jaya, Selangor Darul Ehsan, Malaysia
Tel: +60-3-7955-9390, Fax: +60-3-7955-9510

Renesas Electronics India Pvt. Ltd.
No.777C, 100 Feet Road, HAL II Stage, Indiranagar, Bangalore, India
Tel: +91-80-67208700, Fax: +91-80-67208777

Renesas Electronics Korea Co., Ltd.
12F., 234 Teheran-ro, Gangnam-gu, Seoul, 135-080, Korea
Tel: +82-2-558-3737, Fax: +82-2-558-5141

© 2017 Renesas Electronics Corporation. All rights reserved.

Colophon 6.0