

83 542 0 1 -pole - telescopic button Part number 835420



- High switch rating
- Low level
- Long mechanical life
- Reliability

Part numbers

Type	Functions	Connections
83 542 0 1 -pole - telescopic button	Changeover	W2 solder

Specifications

General characteristics

Microswitch	83 132 0
-------------	----------

Presentation

Threaded barrel	•
Chrome-plated nuts	•
Locating washer	•

Mechanical characteristics

Protection against electric shocks to IEC 536 and NF 20030	Class I
Mechanical durability of operating device (operating cycles)	5×10^5
Weight (g)	25

Other characteristics

<T1>Mounting - Operation</T1>

See basic technical concepts on page 2/4

Principles



Dimensions (mm)

Product

83 542

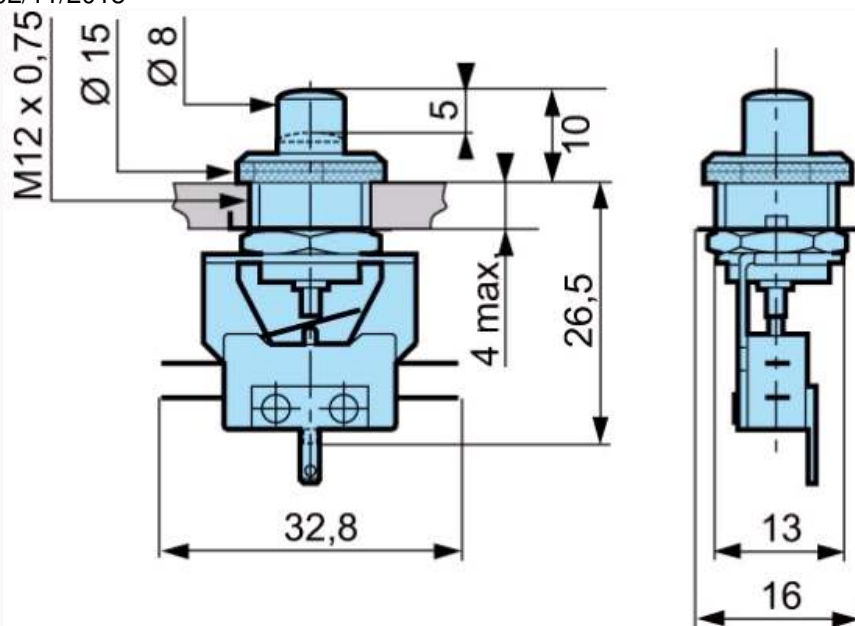

Dimensions (mm)

Connections

W2 à souder

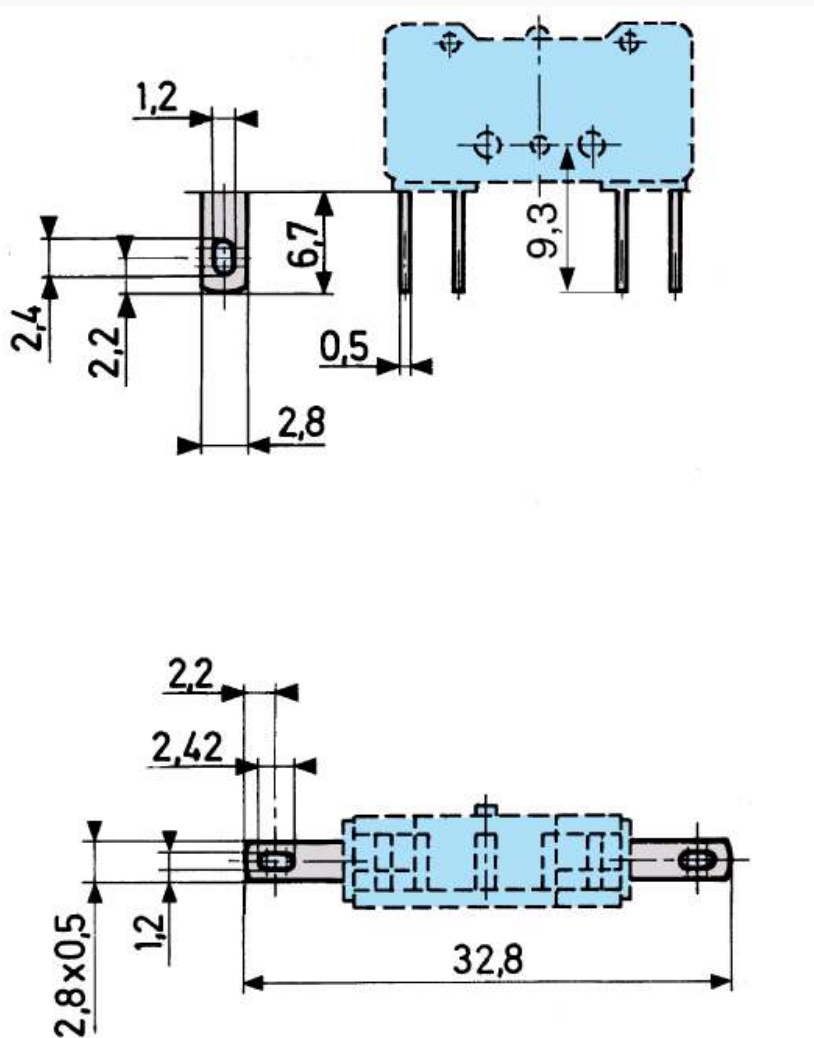

Dimensions (mm)

Drilling

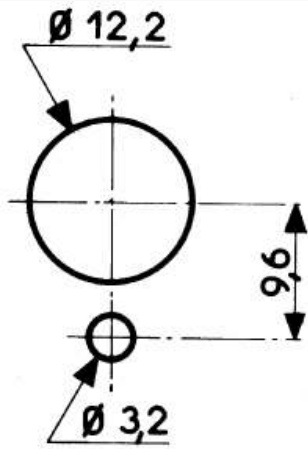

Curves

Courbe d'emploi pour types 83 542 - 83 543 - 83 547 - 83 563

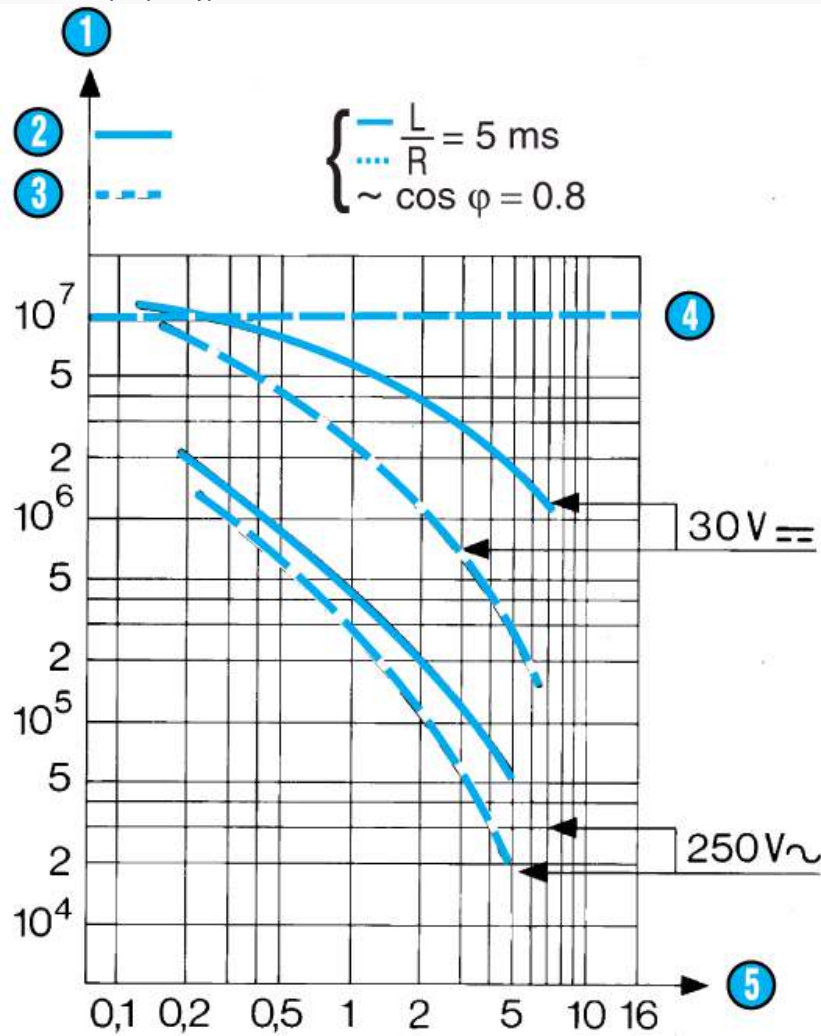

N°	Legend
1	Number of cycles
2	Resistive circuit
3	Inductive circuit
4	Mechanical life limit
5	Rating in Amps

Other information

Accessories : please consult us.