

CPDQ3V3U-HF

RoHS Device
Halogen Free

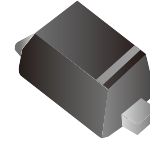

Features

- IEC 61000-4-2 Level 4 ESD protection.
- ESD Rating of Class 3(>16kV) per Human Body Mode.
- Low body height: 0.017"(0.43mm)
- Low Leakage.

Mechanical data

- Epoxy: Meets UL 94V-0
- Case: SOD-923F small outline plastic package.
molded plastic.
- Terminals: Matte tin plated, solderable per
MIL-STD-750, method 2026.
- Mounting position: Any.
- High temperature soldering guaranteed: 260°C/10 second.
- Weight: 0.001 grams (approx.).

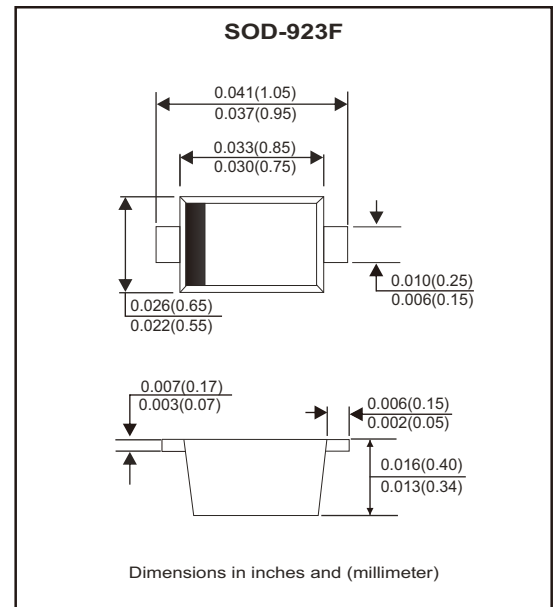

Circuit Diagram

- Pin 1: Cathode
- Pin 2: Anode



Maximum Rating (at TA=25°C unless otherwise noted)

Parameter	Conditions	Symbol	Value	Unit
Typ. peak pulse power	$T_P = 8/20 \mu s$	PPP	102	W
Peak pulse current	$T_P = 8/20 \mu s$	I _{PP}	9.8	A
ESD capability	IEC 61000-4-2(Air)	ESD	±15	kV
	IEC 61000-4-2(Contact)	ESD	±8	kV
Junction temperature range		T _J	-55 to +150	°C
Storage temperature range		T _{STG}	-55 to +150	°C

Electrical Characteristics

(at $T_A=25^\circ\text{C}$ unless otherwise noted. $V_F=0.9\text{V Max.}@ I_F=10\text{mA}$ for all types)

Parameter	Conditions	Symbol	Min	Typ	Max	Unit
Working peak reverse voltage		V_{RWM}			3.3	V
Forward voltage	$I_F = 10\text{mA}$	V_F			0.9	V
Breakdown voltage	$I_T = 1\text{mA}$	V_{BR}	5.0			V
Reverse leakage current	$V_{RWM} = 3.3\text{V}$	I_R			2.5	μA
Clamping voltage	$I_{PP} = 9.8\text{A}$, $T_P = 8/20\mu\text{s}$	V_C			10.4	V
Junction capacitance	$V_R = 0\text{V}$, $f = 1\text{MHz}$	C_J		80		pF

NOTES:

- FR-5= 1.0*0.75*0.62 in.
- Surge current waveform per Figure 3.
- V_{BR} is measured with a pulse test current I_T at an ambient temperature of 25°C .

Rating and Characteristic Curves (CPDQ3V3U-HF)

Fig.1 - Typical Breakdown Voltage Versus Temperature

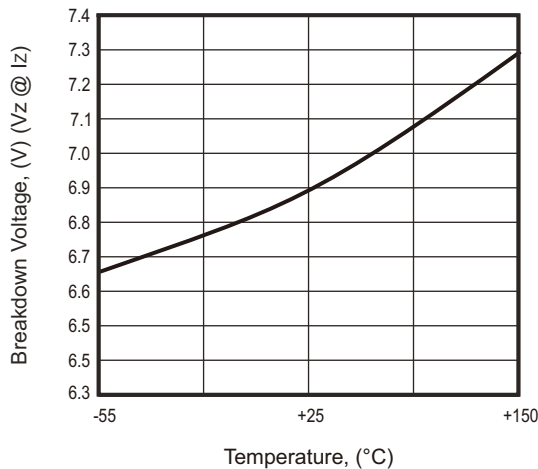

Fig.2 - Typical Leakage Current Versus Temperature

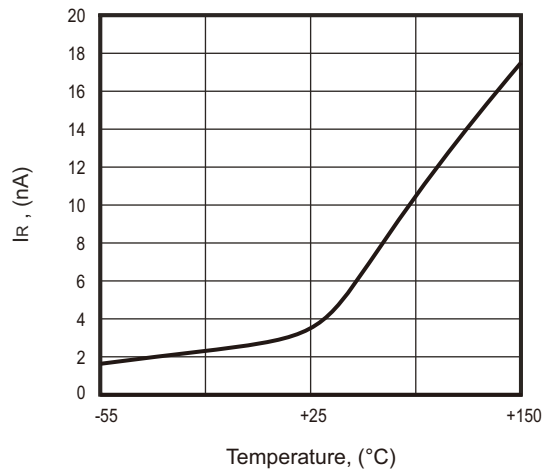
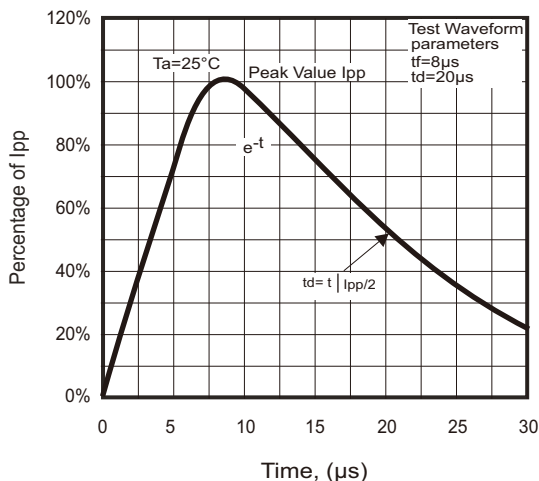
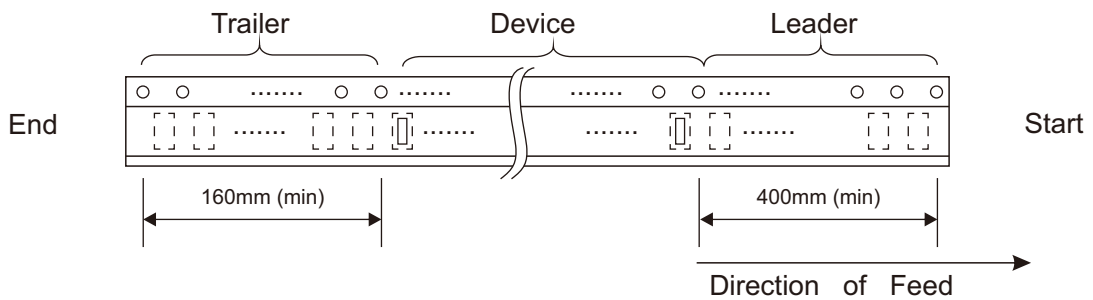
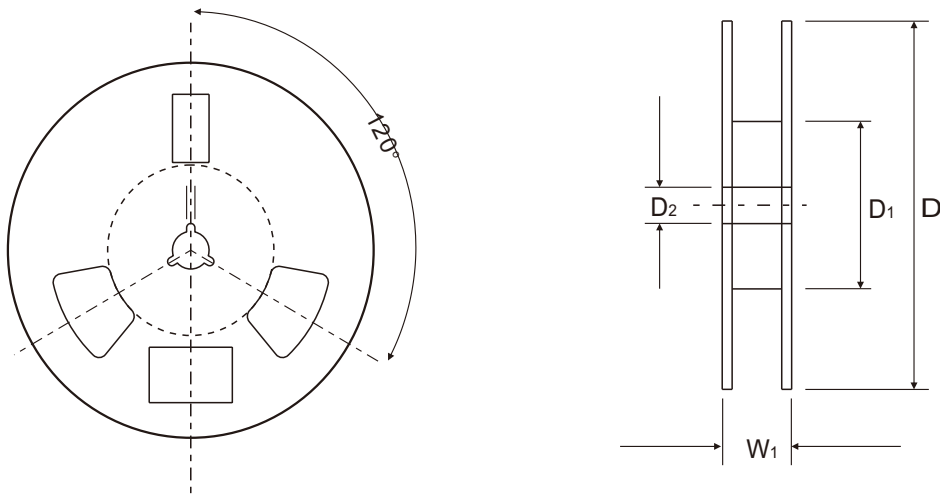
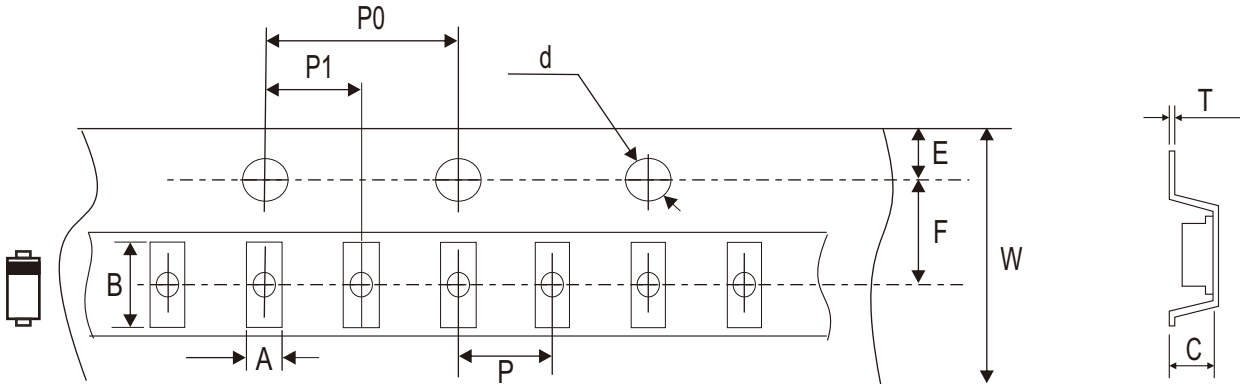

Fig.3 - 8/20 μs Peak Pulse Current Waveform Acc. IEC 61000-4-5



Reel Taping Specification



SOD-923F	SYMBOL	A	B	C	d	D	D ₁	D ₂
	(mm)	0.70 ± 0.05	1.12 ± 0.05	0.48 ± 0.05	1.50 + 0.10 - 0	178.00 Max.	50.00 Min.	13.00 ± 0.50
	(inch)	0.028 ± 0.002	0.044 ± 0.002	0.019 ± 0.002	0.059 + 0.004 - 0	7.008 Max.	1.969 Min.	0.512 ± 0.020

SOD-923F	SYMBOL	E	F	P	P ₀	P ₁	T	W	W
	(mm)	1.75 ± 0.10	3.50 ± 0.05	2.00 ± 0.05	4.00 ± 0.10	2.00 ± 0.05	0.229 ± 0.02	8.30 Max.	10.90 Max.
	(inch)	0.069 ± 0.004	0.138 ± 0.002	0.079 ± 0.002	0.157 ± 0.004	0.079 ± 0.002	0.009 + 0.001	0.327 Max.	0.429 Max.

Company reserves the right to improve product design, functions and reliability without notice.

REV:C

Marking Code

Part Number	Marking Code
CPDQ3V3U-HF	E



E: Product marking code

⌘: Month Code

Month Code:

Month	Odd Year (per A.D.)	Even Year (per A.D.)
Jan	1	E
Feb	2	F
Mar	3	H
Apr	4	J
May	5	K
Jun	6	L
Jul	7	N
Aug	8	P
Sep	9	U
Oct	T	X
Nov	V	Y
Dec	C	Z

For example as follows:

- Product marking code: E
- Manufacture date_ Year: 2012 (Even year) / Month: Apr
Month code: J (Month code rotated 90° and two dots below the month code.)

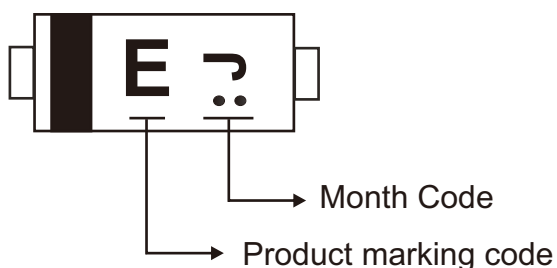

Suggested PAD Layout

SIZE	SOD-923F	
	(mm)	(inch)
A	0.900	0.035
B	0.300	0.012
C	0.400	0.016
D	1.200	0.047
E	0.600	0.024

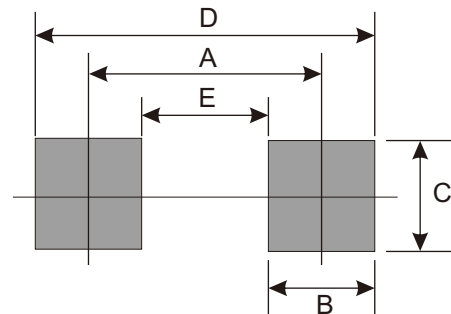

Standard Packaging

Case Type	REEL PACK	
	REEL (pcs)	Reel Size (inch)
SOD-923F	8,000	7