

# RF Power Field Effect Transistors

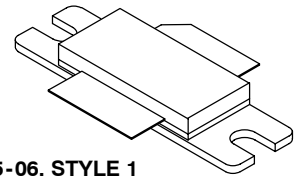
## N-Channel Enhancement-Mode Lateral MOSFETs

Designed for broadband commercial and industrial applications with frequencies from 865 to 895 MHz. The high gain and broadband performance of these devices make them ideal for large-signal, common-source amplifier applications in 26 volt base station equipment.

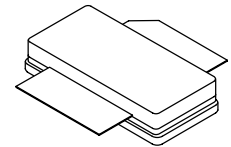
- Typical N-CDMA Performance @ 880 MHz, 26 Volts,  $I_{DQ} = 1100$  mA  
 IS-95 CDMA Pilot, Sync, Paging, Traffic Codes 8 Through 13  
 Output Power — 25 Watts Avg.  
 Power Gain — 17.8 dB  
 Efficiency — 25%  
 Adjacent Channel Power —  
 750 kHz: -47 dBc @ 30 kHz BW
- Internally Matched, for Ease of Use
- High Gain, High Efficiency and High Linearity
- Integrated ESD Protection
- Designed for Maximum Gain and Insertion Phase Flatness
- Capable of Handling 10:1 VSWR, @ 26 Vdc, 880 MHz, 135 Watts CW Output Power
- Excellent Thermal Stability
- Characterized with Series Equivalent Large-Signal Impedance Parameters
- Low Gold Plating Thickness on Leads, 40 $\mu$ m Nominal.
- Pb-Free and RoHS Compliant
- In Tape and Reel. R3 Suffix = 250 Units per 32 mm, 13 inch Reel.

**MRF9135LR3**  
**MRF9135LSR3**

**880 MHz, 135 W, 26 V**  
**LATERAL N-CHANNEL**  
**RF POWER MOSFETs**



**CASE 465-06, STYLE 1**  
**NI-780**  
**MRF9135LR3**



**CASE 465A-06, STYLE 1**  
**NI-780S**  
**MRF9135LSR3**

**Table 1. Maximum Ratings**

Rating	Symbol	Value	Unit
Drain-Source Voltage	$V_{DSS}$	- 0.5, +65	Vdc
Gate-Source Voltage	$V_{GS}$	- 0.5, +15	Vdc
Total Device Dissipation @ $T_C = 25^\circ\text{C}$ Derate above 25 $^\circ\text{C}$	$P_D$	298 1.7	W W/ $^\circ\text{C}$
Storage Temperature Range	$T_{stg}$	- 65 to +200	$^\circ\text{C}$
Operating Junction Temperature	$T_J$	200	$^\circ\text{C}$

**Table 2. Thermal Characteristics**

Characteristic	Symbol	Value (1)	Unit
Thermal Resistance, Junction to Case	$R_{\theta JC}$	0.6	$^\circ\text{C}/\text{W}$

**Table 3. ESD Protection Characteristics**

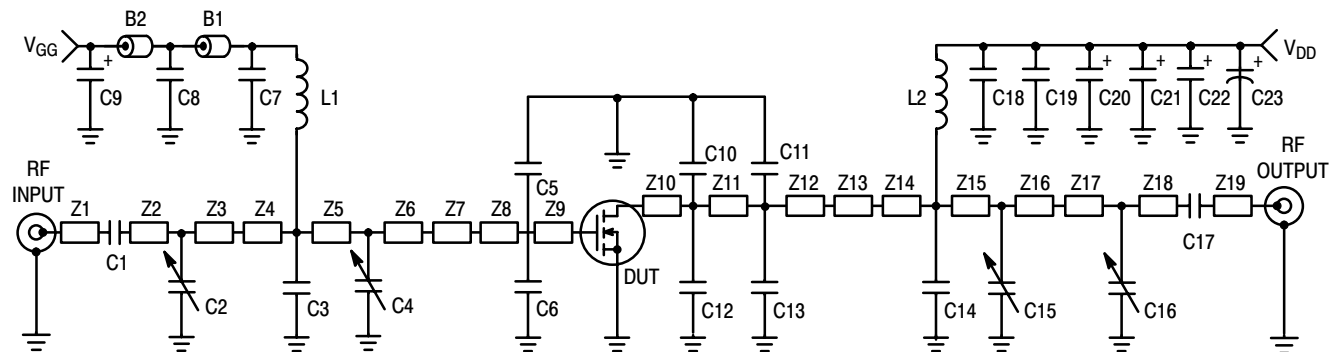
Test Conditions	Class
Human Body Model	1 (Minimum)
Machine Model	M2 (Minimum)
Charge Device Model	C7 (Minimum)

1. MTTF calculator available at <http://www.freescale.com/rf>. Select Tools/Software/Application Software/Calculators to access the MTTF calculators by product.

**NOTE - CAUTION** - MOS devices are susceptible to damage from electrostatic charge. Reasonable precautions in handling and packaging MOS devices should be observed.

**Table 4. Electrical Characteristics** ( $T_C = 25^\circ\text{C}$ , 50 ohm system unless otherwise noted)

Characteristic	Symbol	Min	Typ	Max	Unit
<b>Off Characteristics</b>					
Zero Gate Voltage Drain Leakage Current ( $V_{DS} = 65\text{ Vdc}$ , $V_{GS} = 0\text{ Vdc}$ )	$I_{DSS}$	—	—	10	$\mu\text{Adc}$
Zero Gate Voltage Drain Leakage Current ( $V_{DS} = 26\text{ Vdc}$ , $V_{GS} = 0\text{ Vdc}$ )	$I_{DSS}$	—	—	1	$\mu\text{Adc}$
Gate-Source Leakage Current ( $V_{GS} = 5\text{ Vdc}$ , $V_{DS} = 0\text{ Vdc}$ )	$I_{GSS}$	—	—	1	$\mu\text{Adc}$
<b>On Characteristics</b>					
Gate Threshold Voltage ( $V_{DS} = 10\text{ Vdc}$ , $I_D = 450\ \mu\text{A}$ )	$V_{GS(th)}$	2	2.8	4	Vdc
Gate Quiescent Voltage ( $V_{DS} = 26\text{ Vdc}$ , $I_D = 1100\text{ mA}$ )	$V_{GS(Q)}$	3.25	3.7	5	Vdc
Drain-Source On-Voltage ( $V_{GS} = 10\text{ Vdc}$ , $I_D = 3\text{ Adc}$ )	$V_{DS(on)}$	—	0.19	0.4	Vdc
Forward Transconductance ( $V_{DS} = 10\text{ Vdc}$ , $I_D = 9\text{ Adc}$ )	$g_{fs}$	—	12	—	S
<b>Dynamic Characteristics</b>					
Output Capacitance ( $V_{DS} = 26\text{ Vdc} \pm 30\text{ mV(rms)ac}$ @ 1 MHz, $V_{GS} = 0\text{ Vdc}$ )	$C_{oss}$	—	109	—	pF
Reverse Transfer Capacitance ( $V_{DS} = 26\text{ Vdc} \pm 30\text{ mV(rms)ac}$ @ 1 MHz, $V_{GS} = 0\text{ Vdc}$ )	$C_{rss}$	—	4.4	—	pF
<b>Functional Tests</b> (In Freescale Test Fixture, 50 ohm system) Single-Carrier N-CDMA, 1.2288 MHz Channel Bandwidth Carrier, PAR = 9.8 dB @ 0.01% Probability on CCDF					
Common-Source Amplifier Power Gain ( $V_{DD} = 26\text{ Vdc}$ , $P_{out} = 25\text{ W Avg. N-CDMA}$ , $I_{DQ} = 1100\text{ mA}$ , $f = 880.0\text{ MHz}$ )	$G_{ps}$	16	17.8	—	dB
Drain Efficiency ( $V_{DD} = 26\text{ Vdc}$ , $P_{out} = 25\text{ W Avg. N-CDMA}$ , $I_{DQ} = 1100\text{ mA}$ , $f = 880.0\text{ MHz}$ )	$\eta$	22	25	—	%
Adjacent Channel Power Ratio ( $V_{DD} = 26\text{ Vdc}$ , $P_{out} = 25\text{ W Avg. N-CDMA}$ , $I_{DQ} = 1100\text{ mA}$ , $f = 880.0\text{ MHz}$ ; ACPR @ 25 W, 1.23 MHz Bandwidth, 750 kHz Channel Spacing)	ACPR	—	-47	-45	dBc
Input Return Loss ( $V_{DD} = 26\text{ Vdc}$ , $P_{out} = 25\text{ W Avg. N-CDMA}$ , $I_{DQ} = 1100\text{ mA}$ , $f = 880.0\text{ MHz}$ )	IRL	—	-13.5	-9	dB
Common-Source Amplifier Power Gain ( $V_{DD} = 26\text{ Vdc}$ , $P_{out} = 25\text{ W Avg. N-CDMA}$ , $I_{DQ} = 1100\text{ mA}$ , $f = 865\text{ MHz}$ and $895\text{ MHz}$ )	$G_{ps}$	—	17	—	dB
Drain Efficiency ( $V_{DD} = 26\text{ Vdc}$ , $P_{out} = 25\text{ W Avg. N-CDMA}$ , $I_{DQ} = 1100\text{ mA}$ , $f = 865\text{ MHz}$ and $895\text{ MHz}$ )	$\eta$	—	24	—	%
Adjacent Channel Power Ratio ( $V_{DD} = 26\text{ Vdc}$ , $P_{out} = 25\text{ W Avg. N-CDMA}$ , $I_{DQ} = 1100\text{ mA}$ , $f = 865\text{ MHz}$ and $895\text{ MHz}$ ; ACPR @ 25 W, 1.23 MHz Bandwidth, 750 kHz Channel Spacing)	ACPR	—	-46	—	dBc
Input Return Loss ( $V_{DD} = 26\text{ Vdc}$ , $P_{out} = 25\text{ W Avg. N-CDMA}$ , $I_{DQ} = 1100\text{ mA}$ , $f = 865\text{ MHz}$ and $895\text{ MHz}$ )	IRL	—	-12.5	—	dB
Output Mismatch Stress ( $V_{DD} = 26\text{ Vdc}$ , $P_{out} = 135\text{ W CW}$ , $I_{DQ} = 1100\text{ mA}$ , $f = 880.0\text{ MHz}$ , VSWR = 10:1, All Phase Angles at Frequency of Tests)	$\Psi$	No Degradation In Output Power			

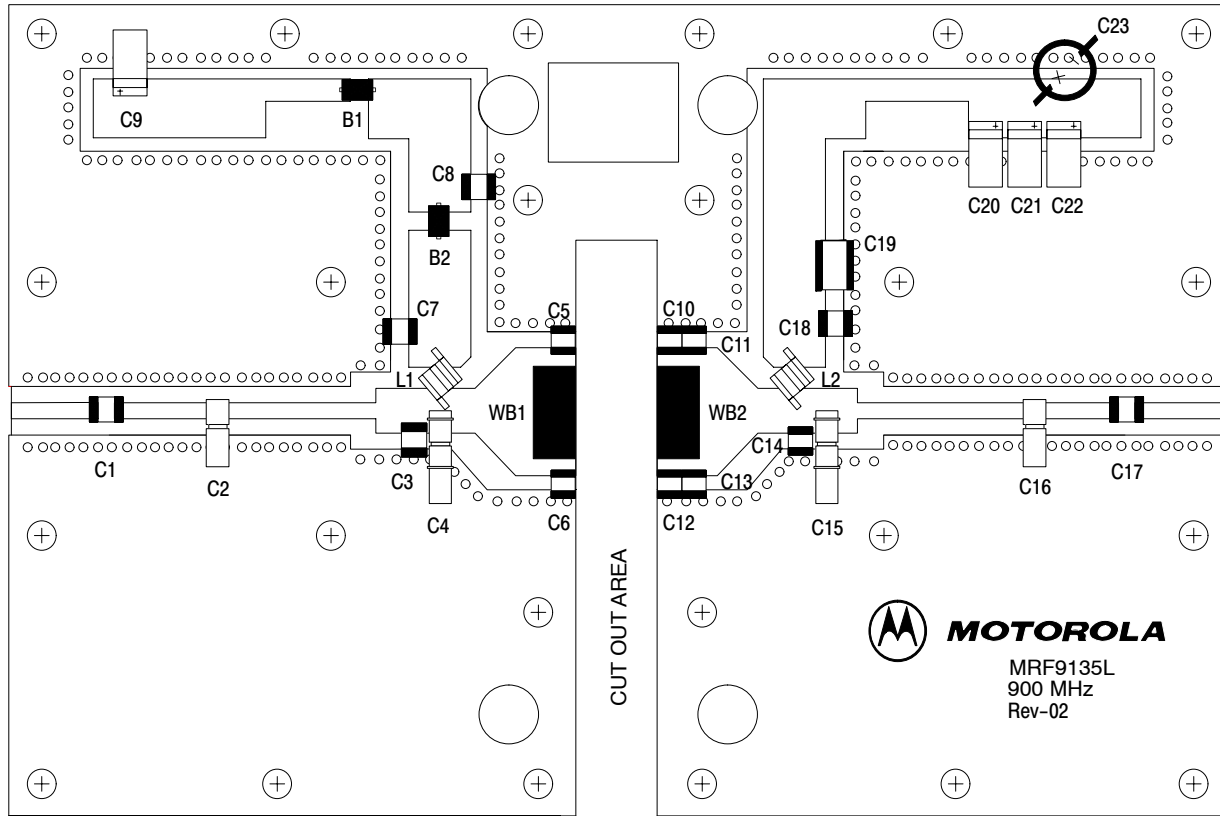


Z1	0.430" x 0.080" Microstrip	Z11	0.105" x 0.630" Microstrip
Z2	0.430" x 0.080" Microstrip	Z12	0.145" x 0.630" Microstrip
Z3	0.800" x 0.080" Microstrip	Z13	0.200" x 0.630" x 0.220" Taper
Z4	0.200" x 0.220" Microstrip	Z14	0.180" x 0.220" Microstrip
Z5	0.110" x 0.220" Microstrip	Z15	0.110" x 0.220" Microstrip
Z6	0.175" x 0.220" Microstrip	Z16	0.200" x 0.220" Microstrip
Z7	0.200" x 0.220" x 0.630" Taper	Z17	0.900" x 0.080" Microstrip
Z8	0.250" x 0.630" Microstrip	Z18	0.360" x 0.080" Microstrip
Z9	0.050" x 0.630" Microstrip	Z19	0.410" x 0.080" Microstrip
Z10	0.050" x 0.630" Microstrip	PCB	Arlon GX-0300-55-22, 0.030", $\epsilon_r = 2.55$

**Figure 1. 880 MHz Test Circuit Schematic**

**Table 5. 880 MHz Test Circuit Component Designations and Values**

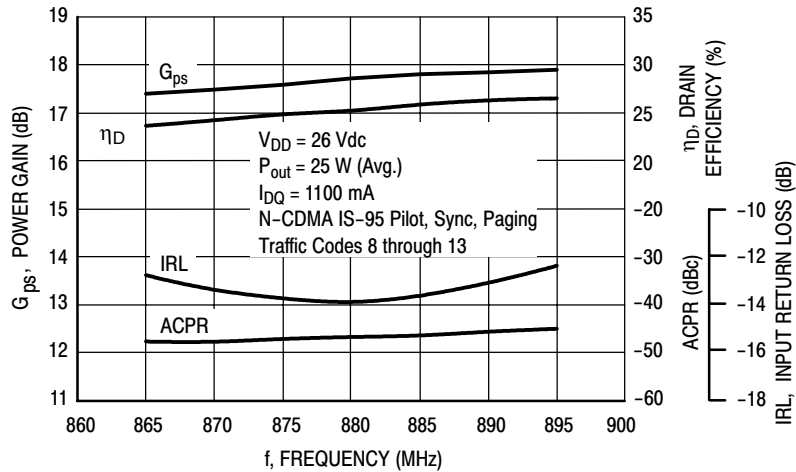
Part	Description	Part Number	Manufacturer
B1, B2	Ferrite Beads, Short	2743019447	Fair Rite
C1, C7, C17, C18	47 pF Chip Capacitors	100B470JP 500X	ATC
C2, C16	0.6-4.5 Variable Capacitors, Gigatrim	27271SL	Johanson
C3	8.2 pF Chip Capacitor	100B8R2BP 500X	ATC
C4, C15	0.8-8.0 Variable Capacitors, Gigatrim	27291SL	Johanson
C5, C6	12 pF Chip Capacitors	100B120JP 500X	ATC
C8	20K pF Chip Capacitor	200B203MP50X	ATC
C9, C20, C21, C22	10 $\mu$ F, 35 V Tantalum Capacitors	T491D106K035AS	Kemet
C10, C11, C12, C13	7.5 pF Chip Capacitors	100B7R5JP 500X	ATC
C14	11 pF Chip Capacitor	100B110JP 500X	ATC
C19	0.56 $\mu$ F, 50 V Chip Capacitor	C1825C564K5RA7800	Kemet
C23	470 $\mu$ F, 63 V Electrolytic Capacitor	SME63VB471M12X25LL	United Chemi-Con
L1, L2	12.5 nH Coilcraft inductors	A04T-5	Coilcraft
WB1, WB2	10 mil Brass Shim (0.205 x 0.530)	RF-Design Lab	RF-Design Lab



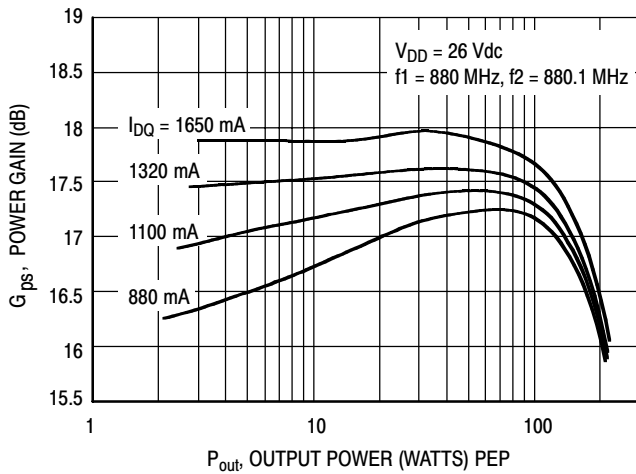
Freescall has begun the transition of marking Printed Circuit Boards (PCBs) with the Freescall Semiconductor signature/logo. PCBs may have either Motorola or Freescall markings during the transition period. These changes will have no impact on form, fit or function of the current product.

**Figure 2. 880 MHz Test Circuit Component Layout**

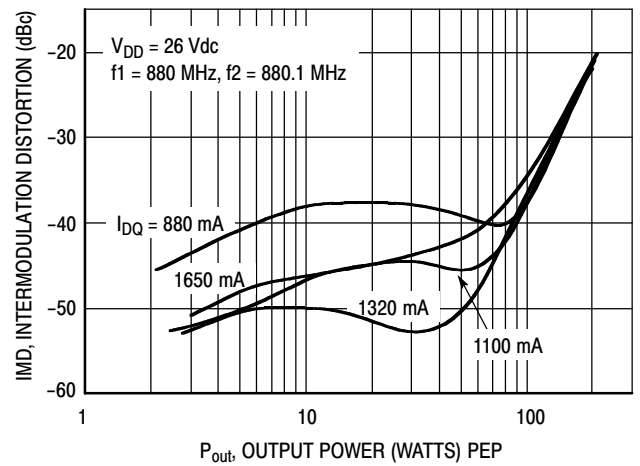
## TYPICAL CHARACTERISTICS



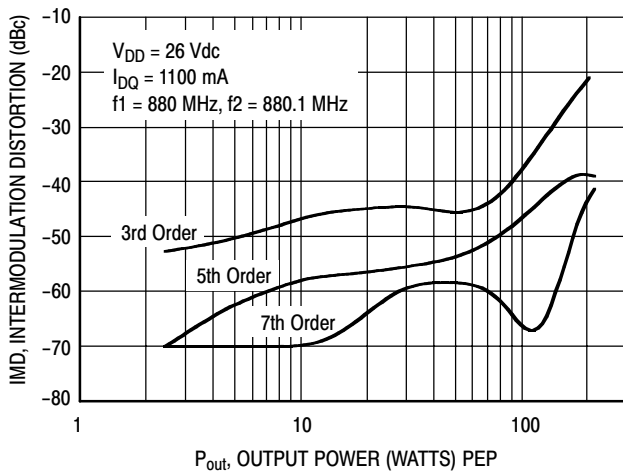
**Figure 3. Class AB Broadband Circuit Performance**



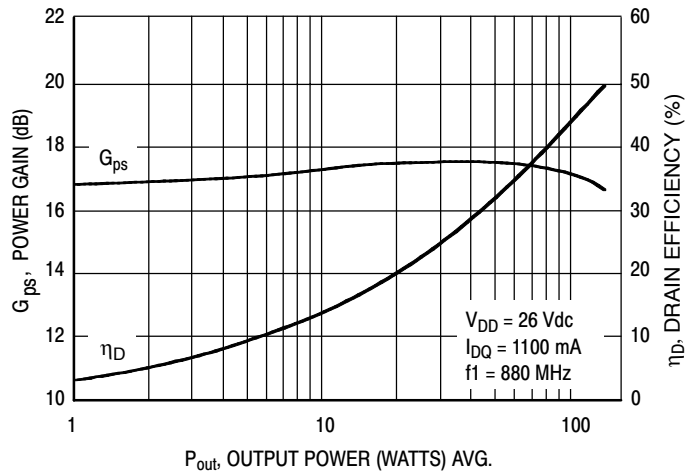
**Figure 4. Power Gain versus Output Power**



**Figure 5. Intermodulation Distortion versus Output Power**

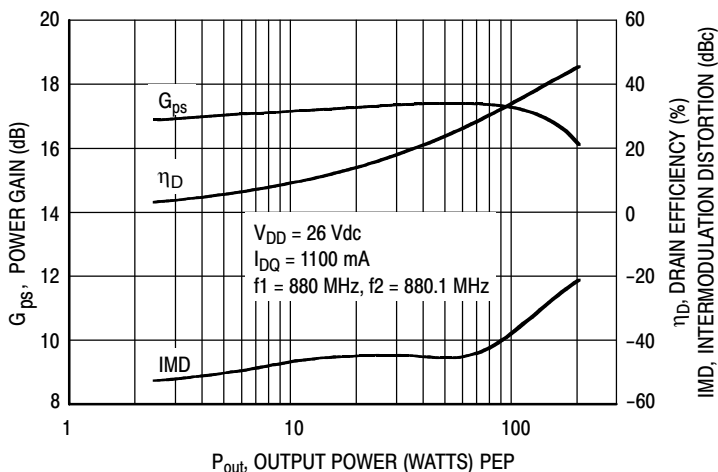


**Figure 6. Intermodulation Distortion Products versus Output Power**

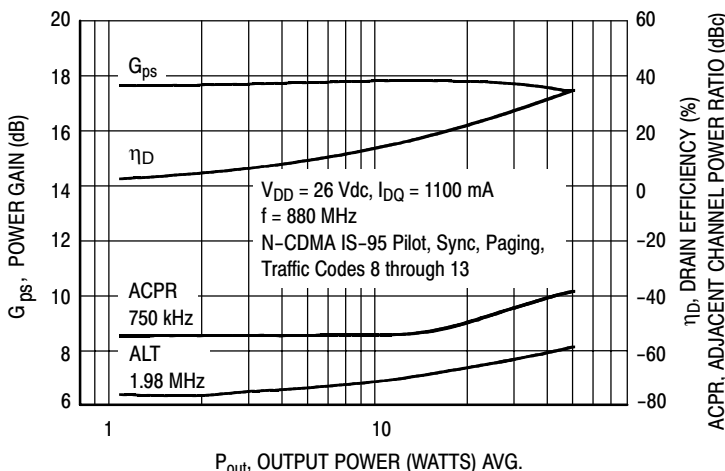


**Figure 7. Power Gain and Efficiency versus Output Power**

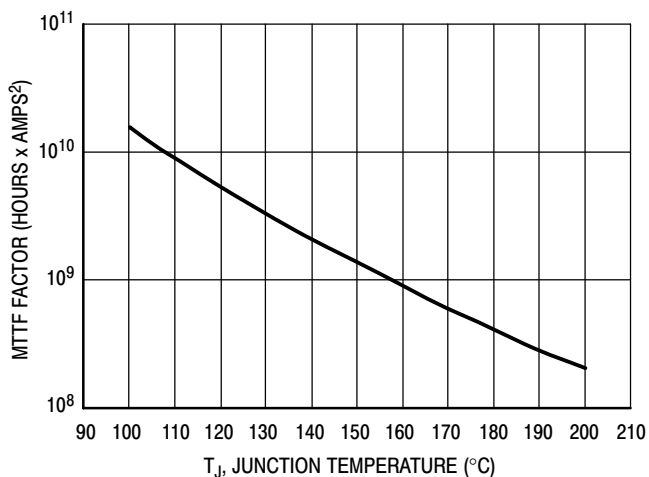
### TYPICAL CHARACTERISTICS



**Figure 8. Power Gain, Efficiency and IMD versus Output Power**



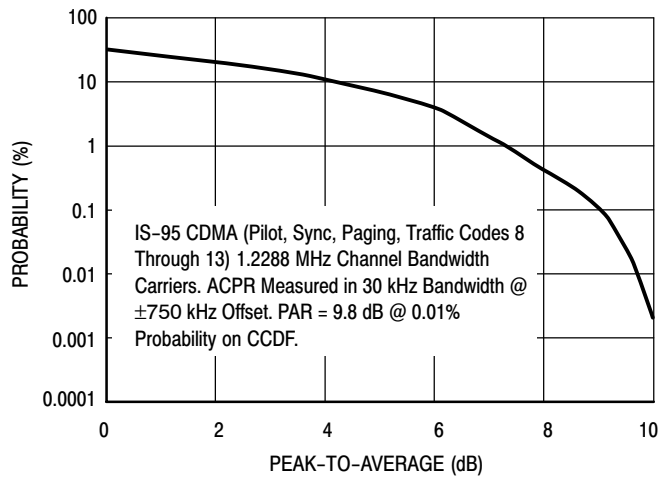
**Figure 9. N-CDMA Performance Output Power versus Gain, ACPR, Efficiency**



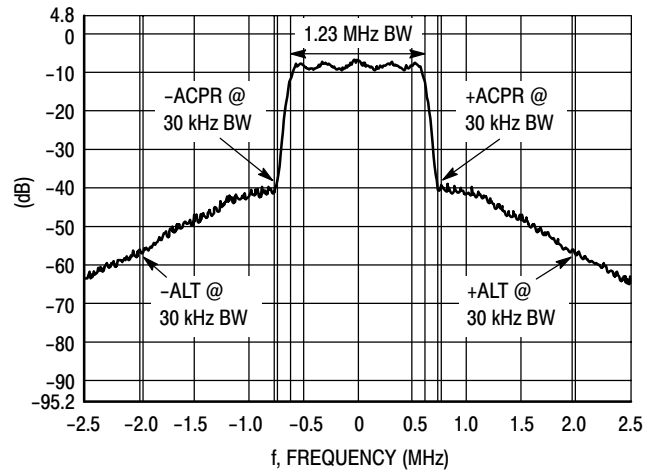
This above graph displays calculated MTTF in hours x ampere<sup>2</sup> drain current. Life tests at elevated temperatures have correlated to better than ±10% of the theoretical prediction for metal failure. Divide MTTF factor by  $I_D^2$  for MTTF in a particular application.

**Figure 10. MTTF Factor versus Junction Temperature**

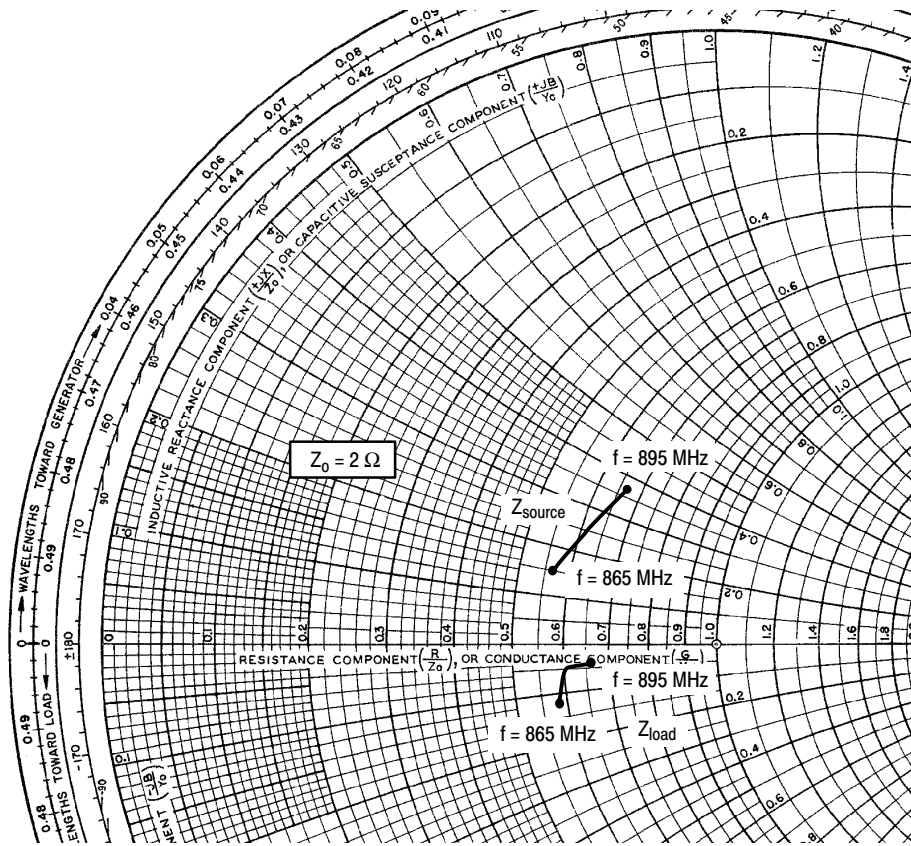
## N-CDMA TEST SIGNAL



**Figure 11. Single-Carrier CCDF N-CDMA**



**Figure 12. Typical CDMA Spectrum**



$V_{DD} = 26\text{ V}$ ,  $I_{DQ} = 1100\text{ mA}$ ,  $P_{out} = 25\text{ W Avg.}$

f MHz	$Z_{source}$ $\Omega$	$Z_{load}$ $\Omega$
865	$1.15 + j0.3$	$1.17 - j0.24$
880	$1.25 + j0.5$	$1.22 - j0.1$
895	$1.35 + j0.75$	$1.32 - j0.07$

$Z_{source}$  = Test circuit impedance as measured from gate to ground.

$Z_{load}$  = Test circuit impedance as measured from drain to ground.

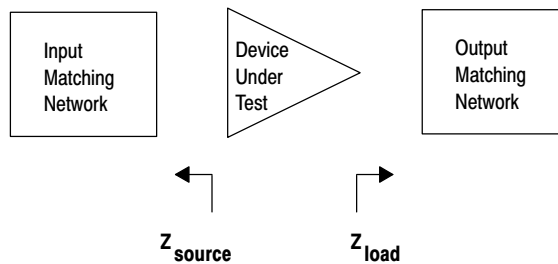


Figure 13. Series Equivalent Source and Load Impedance

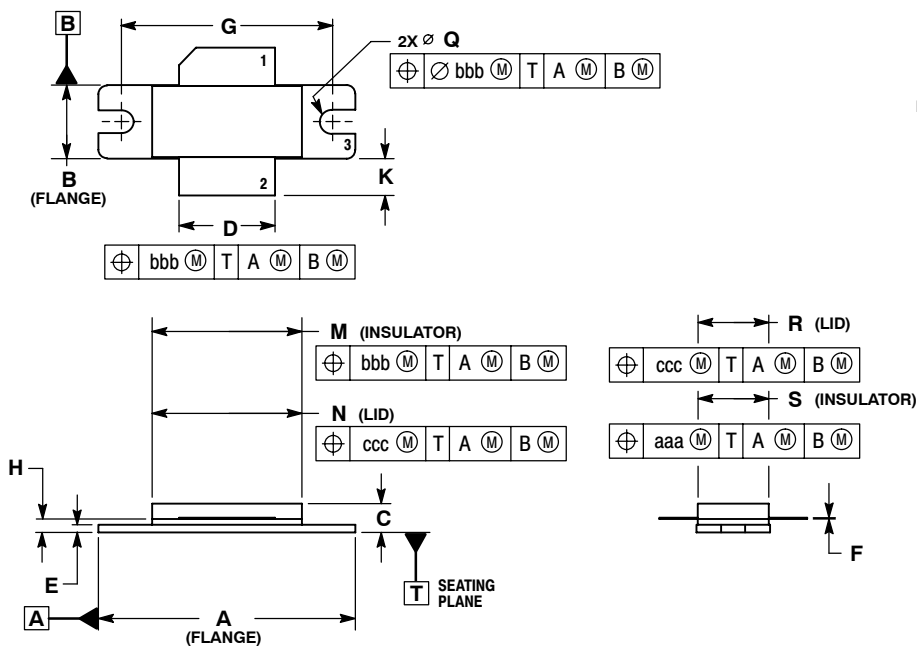




# NOTES

# NOTES

## PACKAGE DIMENSIONS

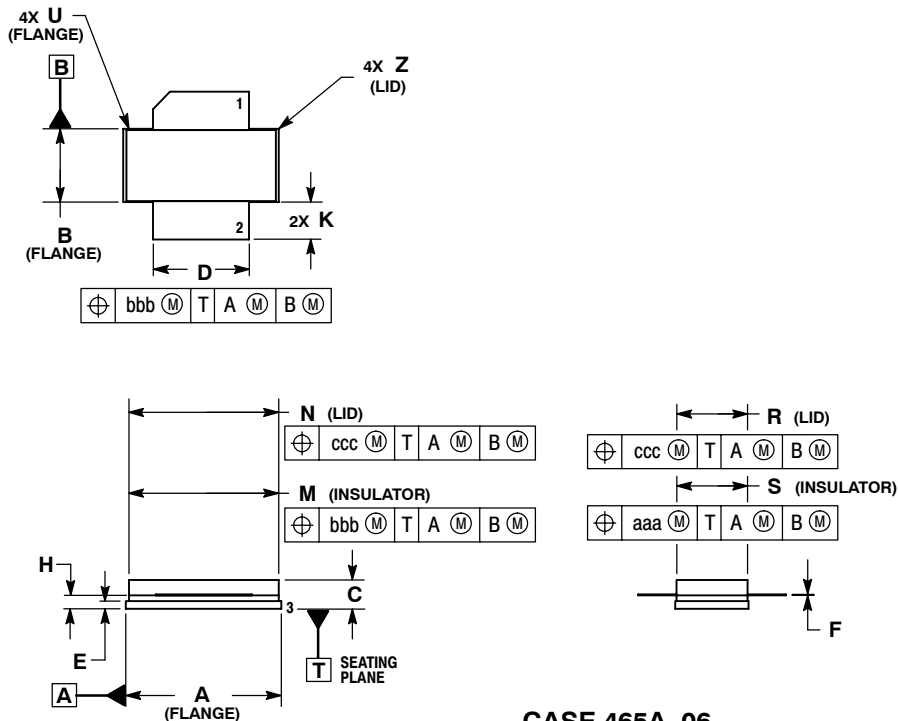


- NOTES:
1. DIMENSIONING AND TOLERANCING PER ANSI Y14.5M-1994.
  2. CONTROLLING DIMENSION: INCH.
  3. DELETED
  4. DIMENSION H IS MEASURED 0.030 (0.762) AWAY FROM PACKAGE BODY.

DIM	INCHES		MILLIMETERS	
	MIN	MAX	MIN	MAX
A	1.335	1.345	33.91	34.16
B	0.380	0.390	9.65	9.91
C	0.125	0.170	3.18	4.32
D	0.495	0.505	12.57	12.83
E	0.035	0.045	0.89	1.14
F	0.003	0.006	0.08	0.15
G	1.100 BSC		27.94 BSC	
H	0.057	0.067	1.45	1.70
K	0.170	0.210	4.32	5.33
M	0.774	0.786	19.66	19.96
N	0.772	0.788	19.60	20.00
Q	Ø.118	Ø.138	Ø3.00	Ø3.51
R	0.365	0.375	9.27	9.53
S	0.365	0.375	9.27	9.52
aaa	0.005 REF		0.127 REF	
bbb	0.010 REF		0.254 REF	
ccc	0.015 REF		0.381 REF	

- STYLE 1:  
 PIN 1. DRAIN  
 2. GATE  
 3. SOURCE

**CASE 465-06  
 ISSUE G  
 NI-780  
 MRF9135LR3**



- NOTES:
1. DIMENSIONING AND TOLERANCING PER ANSI Y14.5M-1994.
  2. CONTROLLING DIMENSION: INCH.
  3. DELETED
  4. DIMENSION H IS MEASURED 0.030 (0.762) AWAY FROM PACKAGE BODY.

DIM	INCHES		MILLIMETERS	
	MIN	MAX	MIN	MAX
A	0.805	0.815	20.45	20.70
B	0.380	0.390	9.65	9.91
C	0.125	0.170	3.18	4.32
D	0.495	0.505	12.57	12.83
E	0.035	0.045	0.89	1.14
F	0.003	0.006	0.08	0.15
H	0.057	0.067	1.45	1.70
K	0.170	0.210	4.32	5.33
M	0.774	0.786	19.61	20.02
N	0.772	0.788	19.61	20.02
R	0.365	0.375	9.27	9.53
S	0.365	0.375	9.27	9.52
U	---	0.040	---	1.02
Z	---	0.030	---	0.76
aaa	0.005 REF		0.127 REF	
bbb	0.010 REF		0.254 REF	
ccc	0.015 REF		0.381 REF	

- STYLE 1:  
 PIN 1. DRAIN  
 2. GATE  
 5. SOURCE

**CASE 465A-06  
 ISSUE H  
 NI-780S  
 MRF9135LSR3**

**MRF9135LR3 MRF9135LSR3**

## **How to Reach Us:**

**Home Page:**  
www.freescale.com

**E-mail:**  
support@freescale.com

**USA/Europe or Locations Not Listed:**  
Freescale Semiconductor  
Technical Information Center, CH370  
1300 N. Alma School Road  
Chandler, Arizona 85224  
+1-800-521-6274 or +1-480-768-2130  
support@freescale.com

**Europe, Middle East, and Africa:**  
Freescale Halbleiter Deutschland GmbH  
Technical Information Center  
Schatzbogen 7  
81829 Muenchen, Germany  
+44 1296 380 456 (English)  
+46 8 52200080 (English)  
+49 89 92103 559 (German)  
+33 1 69 35 48 48 (French)  
support@freescale.com

**Japan:**  
Freescale Semiconductor Japan Ltd.  
Headquarters  
ARCO Tower 15F  
1-8-1, Shimo-Meguro, Meguro-ku,  
Tokyo 153-0064  
Japan  
0120 191014 or +81 3 5437 9125  
support.japan@freescale.com

**Asia/Pacific:**  
Freescale Semiconductor Hong Kong Ltd.  
Technical Information Center  
2 Dai King Street  
Tai Po Industrial Estate  
Tai Po, N.T., Hong Kong  
+800 2666 8080  
support.asia@freescale.com

**For Literature Requests Only:**  
Freescale Semiconductor Literature Distribution Center  
P.O. Box 5405  
Denver, Colorado 80217  
1-800-441-2447 or 303-675-2140  
Fax: 303-675-2150  
LDCForFreescaleSemiconductor@hibbertgroup.com

Information in this document is provided solely to enable system and software implementers to use Freescale Semiconductor products. There are no express or implied copyright licenses granted hereunder to design or fabricate any integrated circuits or integrated circuits based on the information in this document.

Freescale Semiconductor reserves the right to make changes without further notice to any products herein. Freescale Semiconductor makes no warranty, representation or guarantee regarding the suitability of its products for any particular purpose, nor does Freescale Semiconductor assume any liability arising out of the application or use of any product or circuit, and specifically disclaims any and all liability, including without limitation consequential or incidental damages. "Typical" parameters that may be provided in Freescale Semiconductor data sheets and/or specifications can and do vary in different applications and actual performance may vary over time. All operating parameters, including "Typicals", must be validated for each customer application by customer's technical experts. Freescale Semiconductor does not convey any license under its patent rights nor the rights of others. Freescale Semiconductor products are not designed, intended, or authorized for use as components in systems intended for surgical implant into the body, or other applications intended to support or sustain life, or for any other application in which the failure of the Freescale Semiconductor product could create a situation where personal injury or death may occur. Should Buyer purchase or use Freescale Semiconductor products for any such unintended or unauthorized application, Buyer shall indemnify and hold Freescale Semiconductor and its officers, employees, subsidiaries, affiliates, and distributors harmless against all claims, costs, damages, and expenses, and reasonable attorney fees arising out of, directly or indirectly, any claim of personal injury or death associated with such unintended or unauthorized use, even if such claim alleges that Freescale Semiconductor was negligent regarding the design or manufacture of the part.

Freescale™ and the Freescale logo are trademarks of Freescale Semiconductor, Inc. All other product or service names are the property of their respective owners.  
© Freescale Semiconductor, Inc. 2005. All rights reserved.

