

SM2511 Series



1. Features of SM2511 series:

- 7.30 x 6.80 mm foot Print, 3.00mm Max. height SMD Power Inductor for high frequency application. Operating frequency up to 3MHz.
- Inductance range from 0.10uH to 10.00uH. Custom values are welcomed.
- High saturation current characteristics by distributed gapped metal dust core.
- Ideal for portable device, Pad, E-reader and high density DC to DC Converter.
- Operating Temperature Range: -55°C to 125°C .
- T & R Qty: 1000 pcs , 13" Reel and Plastic tape: 16mm wide, 12mm pocket spacing.
- RoHS and HF compliant.



2. Electrical Characteristics of SM2511 series:

ITG Part Number	OCL ¹ (uH) ±20%	DCR (mΩ) Typ. @25°C	DCR (mΩ) Max. @25°C	Isat ² (A) @25°C	Irms ³ (A) @25°C
SM2511-R10MHF	0.10	1.50	1.70	60.00	32.50
SM2511-R22MHF	0.22	2.50	2.80	40.00	23.00
SM2511-R33MHF	0.33	3.50	3.90	30.00	20.00
SM2511-R47MHF	0.47	4.00	4.20	26.00	17.50
SM2511-R68MHF	0.68	5.00	5.50	25.00	15.50
SM2511-R82MHF	0.82	6.70	8.00	24.00	13.00
SM2511-1R0MHF	1.00	9.00	10.00	22.00	11.00
SM2511-1R5MHF	1.50	14.00	15.00	18.00	9.00
SM2511-2R2MHF	2.20	18.00	20.00	14.00	8.00
SM2511-3R3MHF	3.30	28.00	30.00	13.50	6.00
SM2511-4R7MHF	4.70	37.00	40.00	10.00	5.50
SM2511-6R8MHF	6.80	54.00	60.00	8.00	4.50
SM2511-8R2MHF	8.20	64.00	68.0	7.50	4.00
SM2511-100MHF	10.00	102.00	105.00	7.00	3.00

3. Mechanical Dimensions (unit: mm):

A ± 0.30	B ± 0.20	C Max.	D ± 0.30	E ± 0.30
7.00	6.60	3.00	3.00	1.60

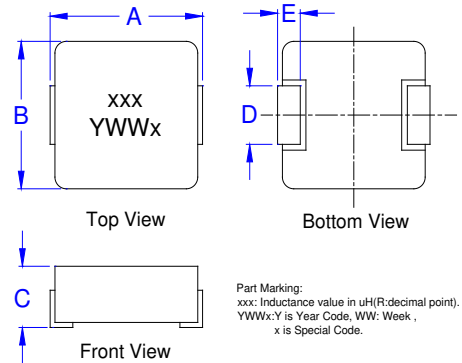

Pad Dimension	SM2511
F	7.37 Typ.
G	3.71 Typ.
H	3.43 Typ.

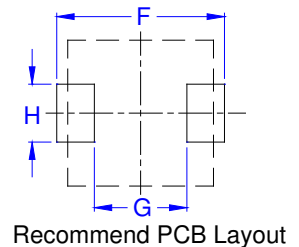

Notes:

1. Test conditions: 100KHz, 1.0V, 25°C ambient temperature .
2. Isat: DC current that causes inductance to drop 20%(Typ.) from OCL (Ta=25°C).
3. Irms: DC current for an approximate temperature rise of 40°C without core loss. Derating is necessary for AC currents. PCB pad layout,trace thickness and width,air-flow and proximity of other heat generating components will affect the temperature rise. It is recommended the part temperature not exceed 125° C under worst case operating conditions as verified in the end application.



4. Inductance vs. Current vs. Temperature Rise Characteristics of SM2511 Series :

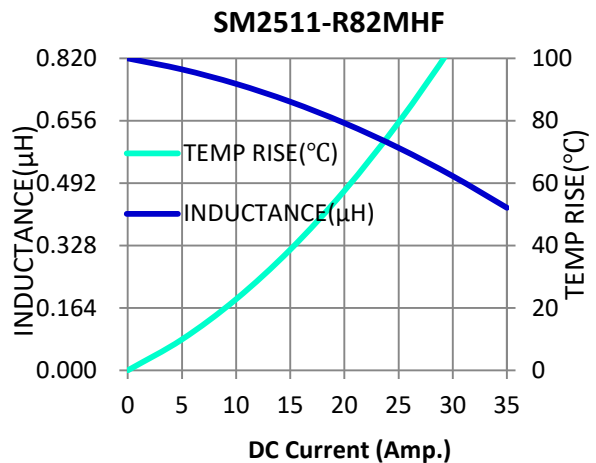
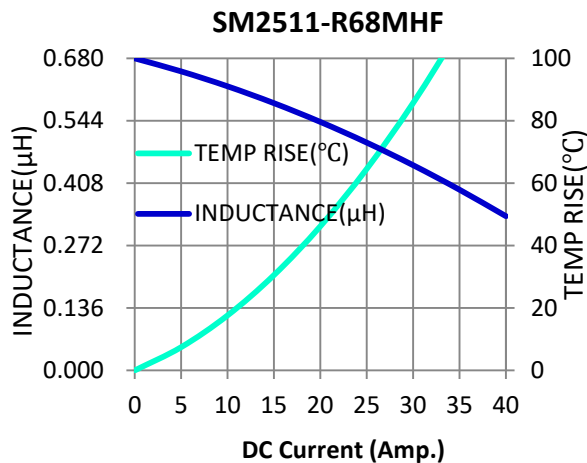
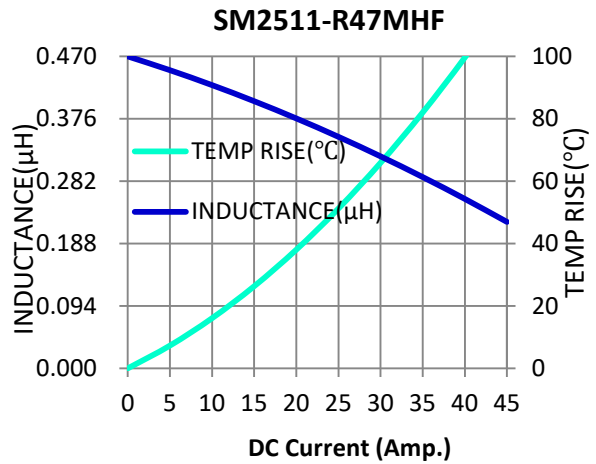
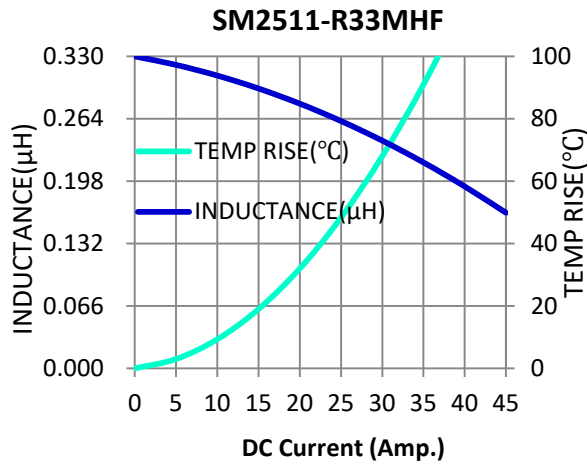
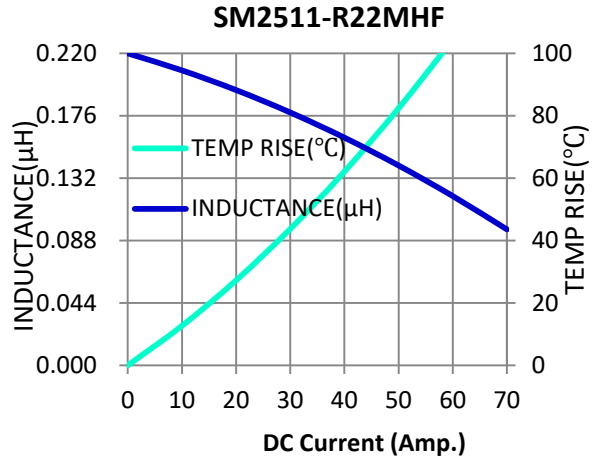
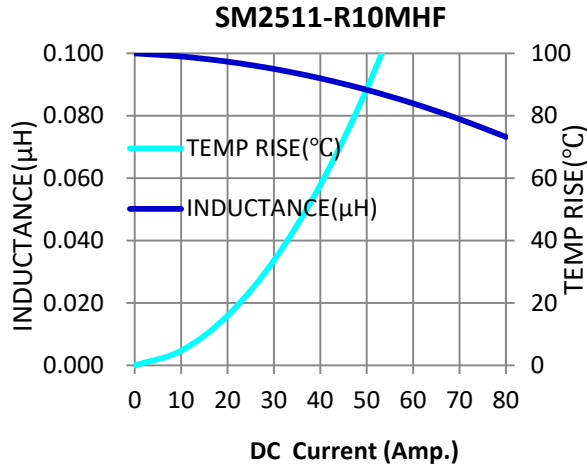



4. Inductance vs. Current vs. Temperature Rise Characteristics of SM2511 Series :

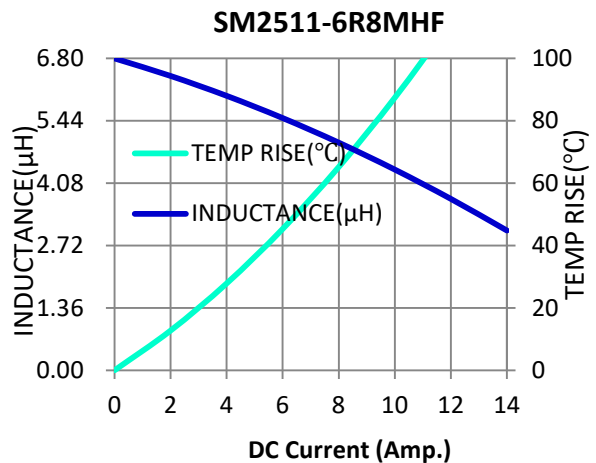
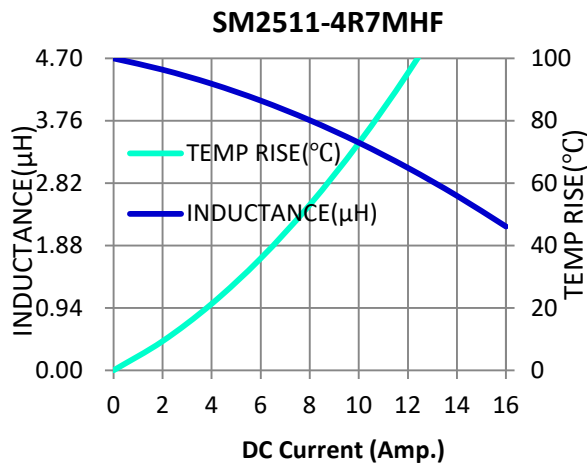
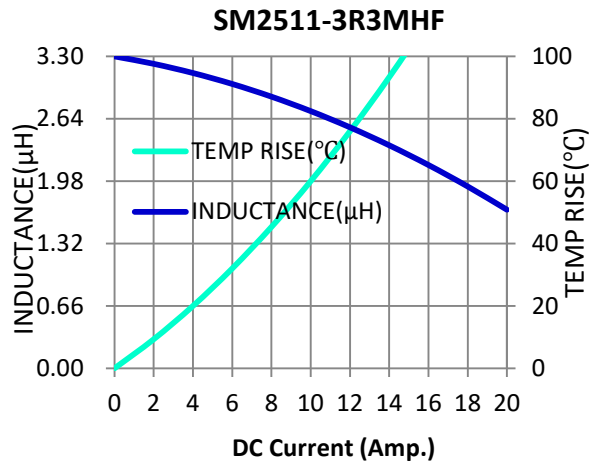
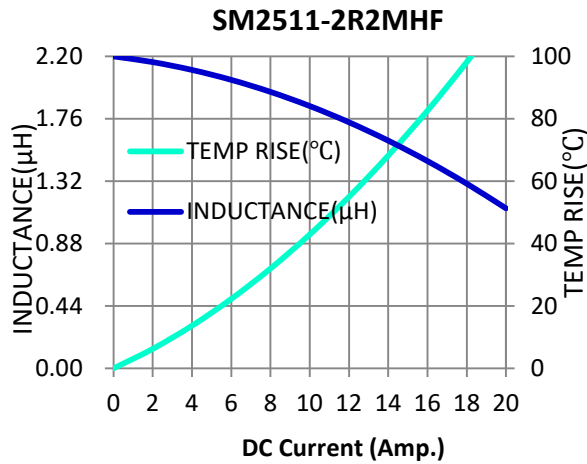
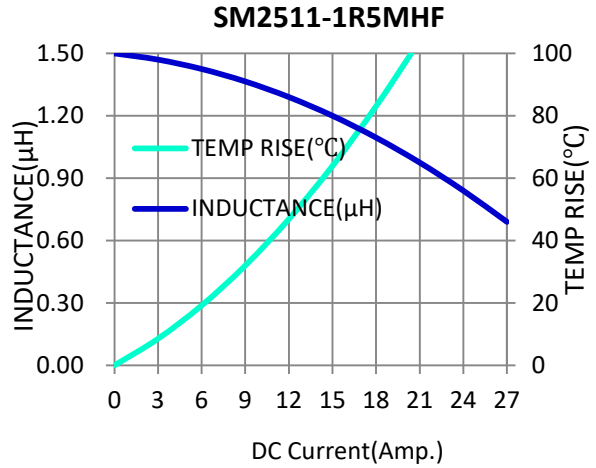
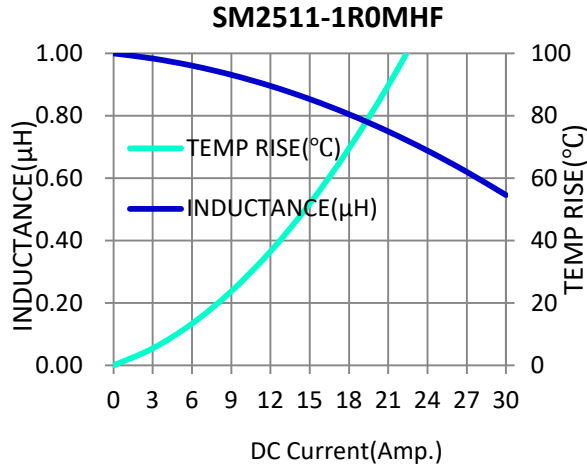

SM2511 Series



4. Inductance vs. Current vs. Temperature Rise Characteristics of SM2511 Series :

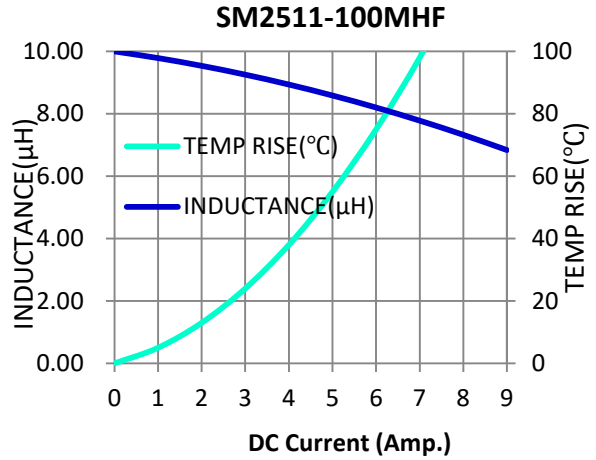
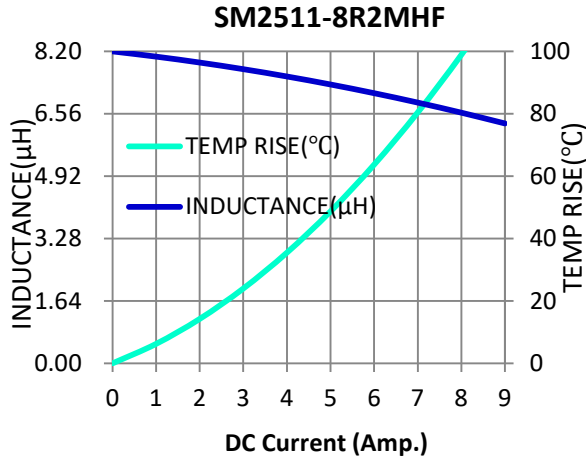

SM2511 Series



5. PACKAGE SPECIFICATION.(UNIT:mm):

(1).ENCAPSULATION MODE:

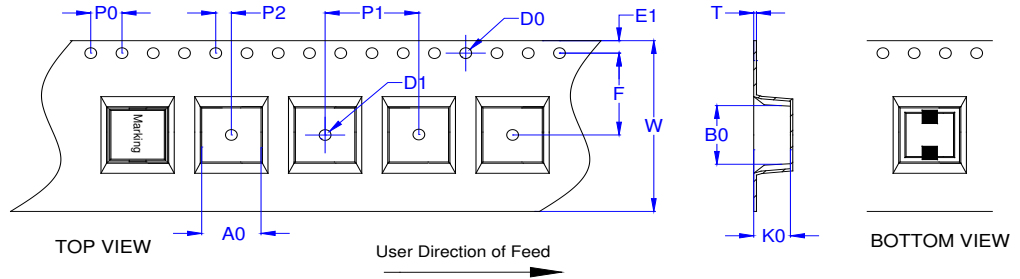

(2).DIMENSION(mm):

W	A0	B0	K0	P1	P0	P2	D0	D1	F	E1	T
16.0±0.30	7.20±0.10	7.50±0.10	3.6±0.15	12.0±0.10	4.0±0.10	2.0±0.10	1.5±0.10	1.5±0.10	7.5±0.10	1.75±0.10	0.31±0.10

(3).REEL SIZE:

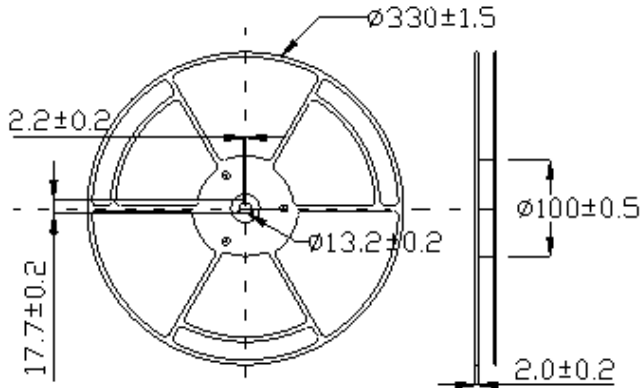

(4).PACKAGE MODE:

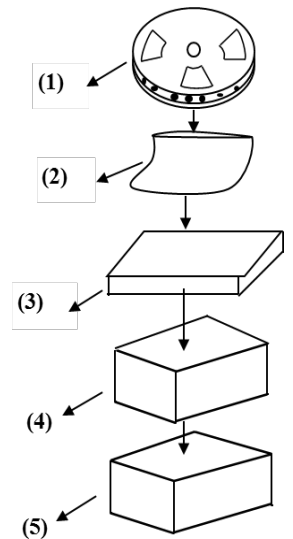

(5).PACKAGING LIST:

No.	Packing Part	Dimension (mm)	Material	Quantity
1	Reel	330	Plastic	1000PCS / Reel
2	Bag	450 X 360 X 0.075	Plastic	1Reel / Bag
3	Small Box	340 X 335 X 45	Paper	2Bag / Small Box
4	Middle Box	356 X 350 X 226	Paper	4Small Boxes / Middle Box
5	Outer Box	378 X 362 X 252	Paper	1Middle Box / Outer Box

(6).WEIGHT: N.W: 0.76 g/pcs (APPROX), TOTAL 6.16 Kg(APPROX),G.W:TOTAL 9.16Kg (APPROX).

(7).Storage conditions: -40°C~85°C ,75%RH (Max.).



6.RELIABILITY TEST:

6.1 Mechanical Reliability		
Item	Specification and Requirement	Test Method and Remarks
Solderability	The surface of terminal immersed shall be minimum of 95% covered with a new coating of solder	According to J-STD-002 Method D category 3 1. Preheating: 160 ± 10 °C 2.Solder: Sn96.5Ag3.0Cu0.5/Sn95.5Ag3.8Cu0.7, Flux: Rosin. 3. Retention time: 255 ± 5 °C for 5 ± 0.5 seconds
Resistance to Soldering Heat	Inductance change: Within ±10% Without mechanical damage such as break	According to MIL-STD-202 Method 210F condition J 1.Solder: 99.3%Sn/0.7%Cu 2.Reflow Peak 235 ± 5 °C(30±5s)/Time above 183°C(90~120s)
Vibration	Inductance change: Within ± 10% Without mechanical damage such as break	According to MIL-STD-202 Method 204D 5g's for 20 minutes, 12 cycles each of 3 orientations. Note: Use 8"X5" PCB, .031" thick, 7 secure points on one long side and 2 secure points at corners of opposite sides. Parts mounted within 2" from any secure point. Test from 10-2000 Hz.
Shock	Inductance change: Within ±10% Without mechanical damage such as break	According to MIL-STD-202 Method 213B 1. Peak value: 100 G 2. Duration of pulse: 11ms 3. 3 times in each positive and negative direction of 3 mutual perpendicular directions.
6.2 Endurance Reliability		
Thermal Shock	Inductance change: Within ± 10% Without distinct damage in appearance	According to JESD22-A104C or MIL-STD-202 Method 107G 1. Repeat 100 cycles as follow: (-55 ± 2 °C; 30 ± 3 min) → (Room temp., 5 min) → (+125 ± 2 °C, 30 ± 3 min) → (Room temp., 1 min) 2. Recovery: 48 + 4 / -0 hours of recovery under the standard condition after the test.
High Temperature & Humidity	Inductance change: Within ± 10% Without distinct damage in appearance	According to MIL-STD-202 Method 103B 240 hours 85°C/85%RH. Unpowered. Measurement at 24±4 hours after test conclusion.
Low Temperature Store	Inductance change: Within ± 10% Without distinct damage in appearance	According to JESD22-A119A or IEC68-2-1 Method A(Ad) Store temperature: -55 ± 2 °C, 1000 + 4 / -0 hours
High Temperature Store	Inductance change: Within ± 10% Without distinct damage in appearance	According to MIL-STD-202 Method 108A Store temperature: +125 ± 2 °C, 1000 + 4 / -0 hours



Soldering Reflow Chart

Solder Reflow Profile:

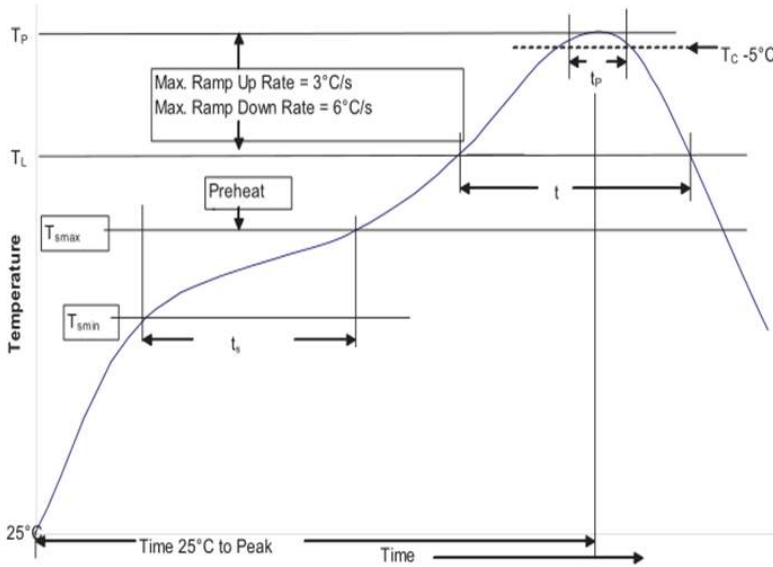

Table 1 - Standard SnPb Solder (T_C)

Package Thickness	Volume mm^3 <350	Volume mm^3 ≥ 350
<2.5mm	235°C	220°C
$\geq 2.5\text{mm}$	220°C	220°C

Table 2 - Lead (Pb) Free Solder (T_C)

Package Thickness	Volume mm^3 <350	Volume mm^3 350 - 2000	Volume mm^3 >2000
<1.6mm	260°C	260°C	260°C
1.6 - 2.5mm	260°C	250°C	245°C
>2.5mm	250°C	245°C	245°C

Reference JEDEC J-STD-020E:

Profile Feature	Standard SnPb Solder	Lead (Pb) Free Solder
Preheat and Soak	• Temperature min. (T_{smin})	100°C
	• Temperature max. (T_{smax})	150°C
	• Time (T_{smin} to T_{smax}) (t_s)	60-120 Seconds
Average ramp up rate T_{smax} to T_p	3°C/ Second Max.	3°C/ Second Max.
Liquidous temperature (T_L)	183°C	217°C
Time at liquidous (t_L)	60-150 Seconds	60-150 Seconds
Peak package body temperature (T_p)*	Table 1	Table 2
Time (t_p)** within 5 °C of the specified classification temperature (T_C)	20 Seconds**	30 Seconds**
Average ramp-down rate (T_p to T_{smax})	6°C/ Second Max.	6°C/ Second Max.
Time 25°C to Peak Temperature	6 Minutes Max.	8 Minutes Max.

* Tolerance for peak profile temperature (T_p) is defined as a supplier minimum and a user maximum.

** Tolerance for time at peak profile temperature (t_p) is defined as a supplier minimum and a user maximum.