

ELECTRICAL / OPTICAL CHARACTERISTICS at $T_A=25^{\circ}\text{C}$

Parameter	Symbol	Emitting Color	Value		Unit
			Typ.	Max.	
Wavelength at Peak Emission $I_F = 20\text{mA}$	λ_{peak}	Mega Green	574	-	nm
Dominant Wavelength $I_F = 20\text{mA}$	$\lambda_{\text{dom}}^{[1]}$	Mega Green	570	-	nm
Spectral Bandwidth at 50% Φ REL MAX $I_F = 20\text{mA}$	$\Delta\lambda$	Mega Green	26	-	nm
Capacitance	C	Mega Green	20	-	pF
Forward Voltage $I_F = 20\text{mA}$	$V_F^{[2]}$	Mega Green	2.1	2.5	V
Reverse Current ($V_R = 5\text{V}$)	I_R	Mega Green	-	10	μA

Notes:

1. The dominant wavelength (λ_d) above is the setup value of the sorting machine. (Tolerance $\lambda_d : \pm 1\text{nm}$.)
2. Forward voltage: $\pm 0.1\text{V}$.
3. Wavelength value is traceable to CIE127-2007 standards.
4. Excess driving current and / or operating temperature higher than recommended conditions may result in severe light degradation or premature failure.

ABSOLUTE MAXIMUM RATINGS at $T_A=25^{\circ}\text{C}$

Parameter	Symbol	Value	Unit
Power Dissipation	P_D	75	mW
Reverse Voltage	V_R	5	V
Junction Temperature	T_j	115	$^{\circ}\text{C}$
Operating Temperature	T_{op}	-40 to +85	$^{\circ}\text{C}$
Storage Temperature	T_{stg}	-40 to +85	$^{\circ}\text{C}$
DC Forward Current	I_F	30	mA
Peak Forward Current	$I_{\text{FM}}^{[1]}$	150	mA
Electrostatic Discharge Threshold (HBM)	-	3000	V

Notes:

1. 1/10 Duty Cycle, 0.1ms Pulse Width.
2. Relative humidity levels maintained between 40% and 60% in production area are recommended to avoid the build-up of static electricity – Ref JEDEC/JESD625-A and JEDEC/J-STD-033.

TECHNICAL DATA

RELATIVE INTENSITY vs. WAVELENGTH

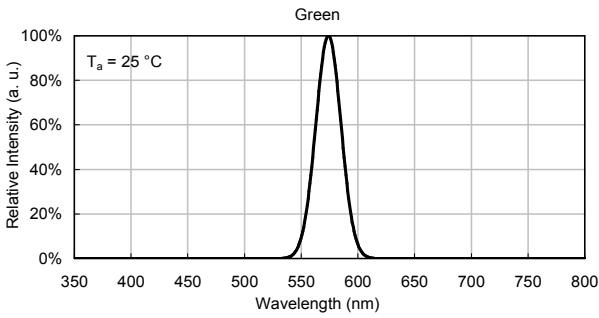

SPATIAL DISTRIBUTION

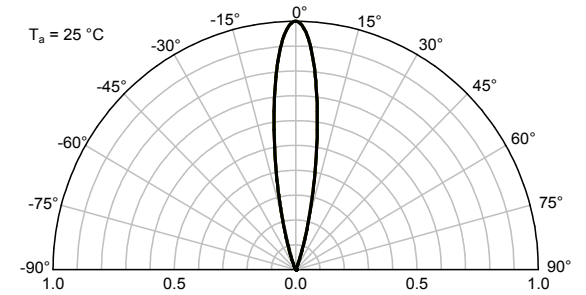

MEGA GREEN

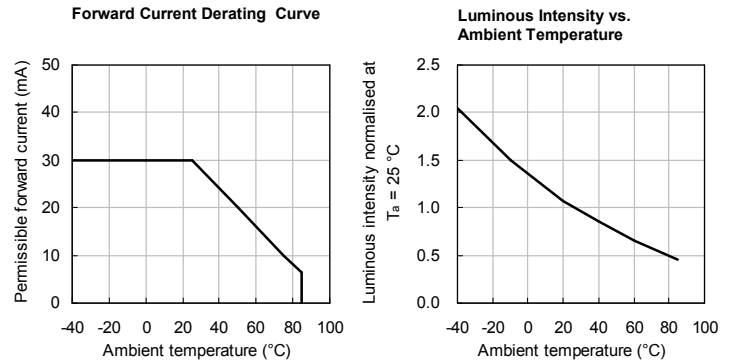
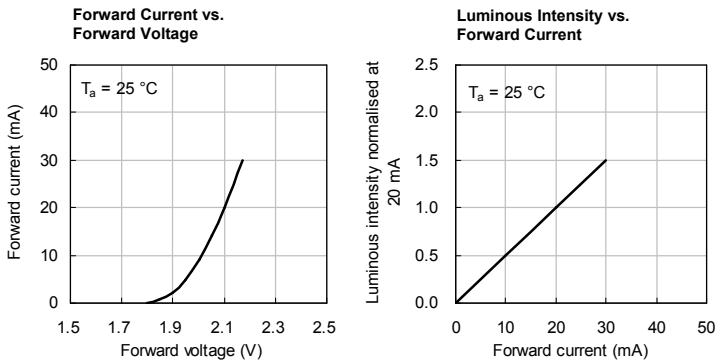

REFLOW SOLDERING PROFILE for LEAD-FREE SMD PROCESS

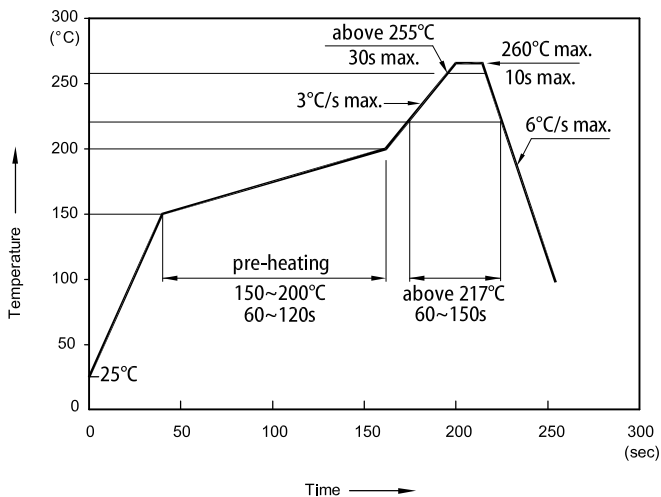

TAPE SPECIFICATIONS (units : mm)

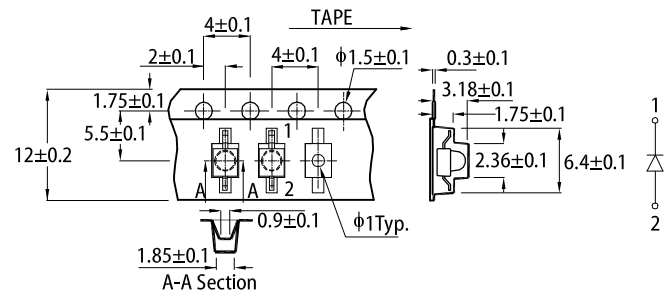

REEL DIMENSION (units : mm)

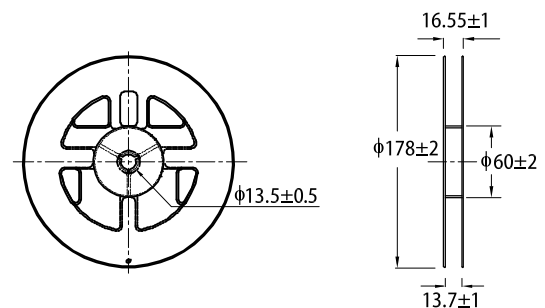

- Notes:
1. Don't cause stress to the LEDs while it is exposed to high temperature.
 2. The maximum number of reflow soldering passes is 2 times.
 3. Reflow soldering is recommended. Other soldering methods are not recommended as they might cause damage to the product.

PACKING & LABEL SPECIFICATIONS

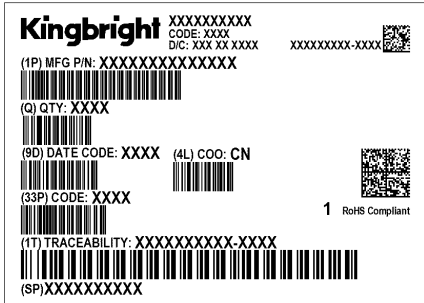
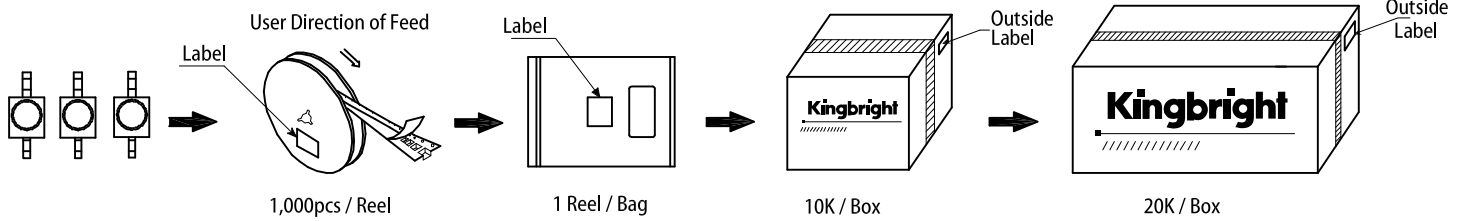

PRECAUTIONARY NOTES

1. The information included in this document reflects representative usage scenarios and is intended for technical reference only.
2. The part number, type, and specifications mentioned in this document are subject to future change and improvement without notice. Before production usage customer should refer to the latest datasheet for the updated specifications.
3. When using the products referenced in this document, please make sure the product is being operated within the environmental and electrical limits specified in the datasheet. If customer usage exceeds the specified limits, Kingbright will not be responsible for any subsequent issues.
4. The information in this document applies to typical usage in consumer electronics applications. If customer's application has special reliability requirements or have life-threatening liabilities, such as automotive or medical usage, please consult with Kingbright representative for further assistance.
5. The contents and information of this document may not be reproduced or re-transmitted without permission by Kingbright.
6. All design applications should refer to Kingbright application notes available at <https://www.KingbrightUSA.com/ApplicationNotes>