

Overview

The KEMET SS Coils, SS17VA/HA Type AC line filters are offered in a wide variety of sizes and specifications.

Applications

- Consumer Electronics
- Common mode choke

Benefits

- Wide variety of sizes and specifications
- Inductances up to 20 mH
- Rated Currents up to 1.7 A
- DC Resistances as low as 0.12 Ω

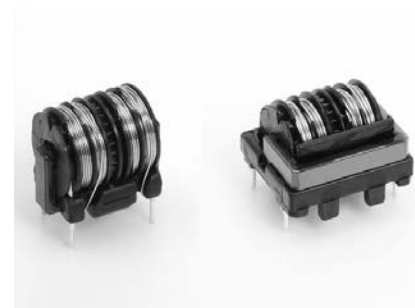

Part Number System

| SS | 17 | VA- | R | 03 | 155 |
|--------|----------------|------------------------------------|---|---|---|
| Series | Core Size (mm) | Core Orientation | Core Type | Rated Current AC (A) | Inductance (mH) Minimum |
| SS | 17 = 17.0 mm | VA- = Vertical HA- = Horizontal | Blank = Standard R = High permeability | 0x = 0.x A xx = x.x A Examples: 03 = 0.3 A 13 = 1.3 A | 00x = 0.x mH 0xx = x.x mH xxx = xx.x mH Examples: 005 = 0.5 mH 035 = 3.5 mH 155 = 15.5 mH |

Dimensions – Millimeters

SS17VA

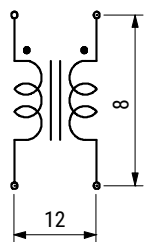
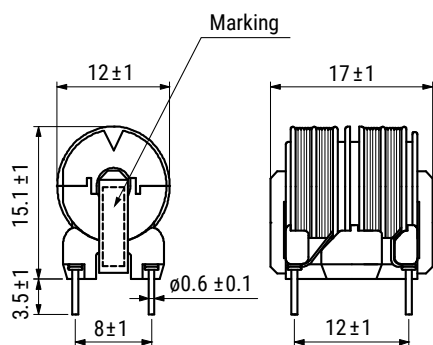

SS17HA

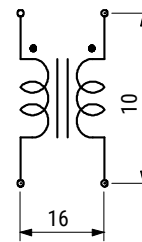
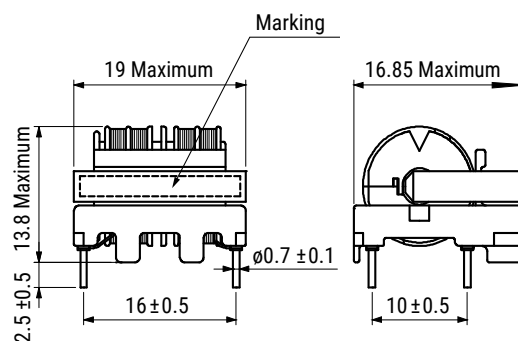

Environmental Compliance

All KEMET AC Line Filters are RoHS Compliant.



Table 1 – Ratings & Part Number Reference

| Part Number | Rated Current AC (A) | Inductance (mH) Minimum | DC Resistance/ Line (Ω) Maximum | Temperature Rise (K) Maximum | Wire Diameter (mm) | Marking | Weight (g) Approximate |
|---------------|----------------------|-------------------------|--|------------------------------|--------------------|-------------|------------------------|
| SS17HA-03155 | 0.3 | 15.5 | 2.60 | 48 | 0.20 | 03 Lot No. | 5.7 |
| SS17VA-03155 | 0.3 | 15.5 | 2.60 | 48 | 0.20 | 03 Lot No. | 5.7 |
| SS17HA-04085 | 0.4 | 8.5 | 1.40 | 53 | 0.23 | 04 Lot No. | 5.6 |
| SS17VA-04085 | 0.4 | 8.5 | 1.40 | 53 | 0.23 | 04 Lot No. | 5.6 |
| SS17HA-05070 | 0.5 | 7.0 | 1.10 | 55 | 0.25 | 05 Lot No. | 5.8 |
| SS17VA-05070 | 0.5 | 7.0 | 1.10 | 55 | 0.25 | 05 Lot No. | 5.8 |
| SS17HA-06060 | 0.6 | 6.0 | 0.84 | 45 | 0.28 | 06 Lot No. | 5.8 |
| SS17VA-06060 | 0.6 | 6.0 | 0.84 | 45 | 0.28 | 06 Lot No. | 5.8 |
| SS17HA-07045 | 0.7 | 4.5 | 0.70 | 50 | 0.30 | 07 Lot No. | 5.9 |
| SS17VA-07045 | 0.7 | 4.5 | 0.70 | 50 | 0.30 | 07 Lot No. | 5.9 |
| SS17HA-08035 | 0.8 | 3.5 | 0.45 | 58 | 0.30 | 08 Lot No. | 8.9 |
| SS17VA-08035 | 0.8 | 3.5 | 0.45 | 58 | 0.30 | 08 Lot No. | 8.9 |
| SS17HA-10015 | 1.0 | 1.5 | 0.38 | 50 | 0.37 | 10 Lot No. | 6.0 |
| SS17VA-10015 | 1.0 | 1.5 | 0.38 | 50 | 0.37 | 10 Lot No. | 6.0 |
| SS17HA-11013 | 1.1 | 1.3 | 0.24 | 65 | 0.37 | 11 Lot No. | 5.7 |
| SS17VA-11013 | 1.1 | 1.3 | 0.24 | 65 | 0.37 | 11 Lot No. | 5.7 |
| SS17HA-13010 | 1.3 | 1.0 | 0.18 | 55 | 0.40 | 13 Lot No. | 5.7 |
| SS17VA-13010 | 1.3 | 1.0 | 0.18 | 55 | 0.40 | 13 Lot No. | 5.7 |
| SS17HA-17005 | 1.7 | 0.5 | 0.12 | 55 | 0.45 | 17 Lot No. | 5.7 |
| SS17VA-17005 | 1.7 | 0.5 | 0.12 | 55 | 0.45 | 17 Lot No. | 5.7 |
| SS17HA-R03200 | 0.3 | 20.0 | 2.60 | 48 | 0.20 | R03 Lot No. | 5.7 |
| SS17VA-R03200 | 0.3 | 20.0 | 2.60 | 48 | 0.20 | R03 Lot No. | 5.7 |
| SS17HA-R04110 | 0.4 | 11.0 | 1.40 | 53 | 0.23 | R04 Lot No. | 5.6 |
| SS17VA-R04110 | 0.4 | 11.0 | 1.40 | 53 | 0.23 | R04 Lot No. | 5.6 |
| SS17HA-R05090 | 0.5 | 9.0 | 1.10 | 55 | 0.25 | R05 Lot No. | 5.8 |
| SS17VA-R05090 | 0.5 | 9.0 | 1.10 | 55 | 0.25 | R05 Lot No. | 5.8 |
| SS17HA-R06075 | 0.6 | 7.5 | 0.84 | 45 | 0.28 | R06 Lot No. | 5.8 |
| SS17VA-R06075 | 0.6 | 7.5 | 0.84 | 45 | 0.28 | R06 Lot No. | 5.8 |
| SS17HA-R07060 | 0.7 | 6.0 | 0.70 | 50 | 0.30 | R07 Lot No. | 5.9 |
| SS17VA-R07060 | 0.7 | 6.0 | 0.70 | 50 | 0.30 | R07 Lot No. | 5.9 |
| SS17HA-R08045 | 0.8 | 4.5 | 0.45 | 58 | 0.30 | R08 Lot No. | 8.9 |
| SS17VA-R08045 | 0.8 | 4.5 | 0.45 | 58 | 0.30 | R08 Lot No. | 8.9 |
| SS17HA-R10025 | 1.0 | 2.5 | 0.38 | 50 | 0.37 | R10 Lot No. | 6.0 |
| SS17VA-R10025 | 1.0 | 2.5 | 0.38 | 50 | 0.37 | R10 Lot No. | 6.0 |
| SS17HA-R11015 | 1.1 | 1.5 | 0.24 | 65 | 0.37 | R11 Lot No. | 5.7 |
| SS17VA-R11015 | 1.1 | 1.5 | 0.24 | 65 | 0.37 | R11 Lot No. | 5.7 |
| SS17HA-R13012 | 1.3 | 1.2 | 0.18 | 55 | 0.40 | R13 Lot No. | 5.7 |
| SS17VA-R13012 | 1.3 | 1.2 | 0.18 | 55 | 0.40 | R13 Lot No. | 5.7 |
| SS17HA-R17007 | 1.7 | 0.7 | 0.12 | 55 | 0.45 | R17 Lot No. | 5.7 |
| SS17VA-R17007 | 1.7 | 0.7 | 0.12 | 55 | 0.45 | R17 Lot No. | 5.7 |

Performance Characteristics

| Item | SS17VA/HA |
|----------------------------------|---|
| Rated Voltage | 250 VAC |
| Withstanding Voltage | 2,400 VAC (2 seconds, between lines) |
| Rated Current AC Range | 0.3 – 1.7 A |
| Rated Inductance Range | 0.5 – 20.0 mH minimum |
| Inductance Measurement Condition | 1 kHz |
| Thermal Class | E (120°C) |
| Operating Temperature Range | -25°C to +120°C (include self temperature rise) |

Frequency Characteristics

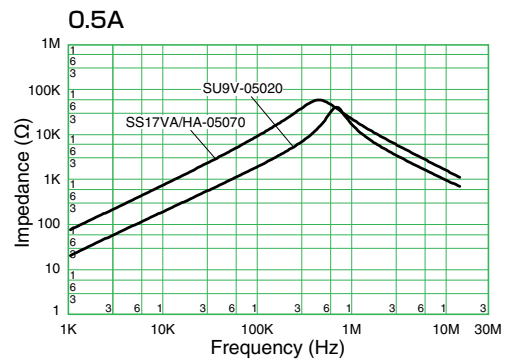
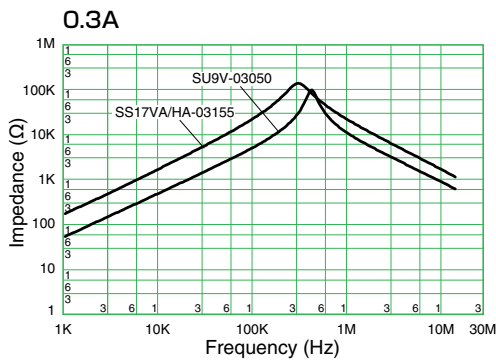
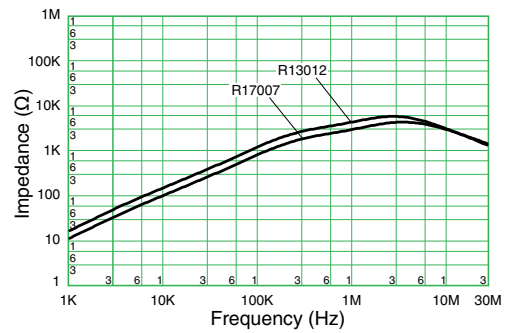
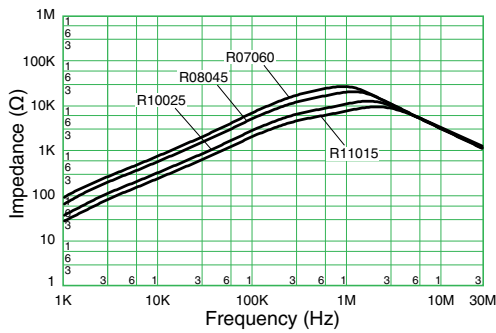
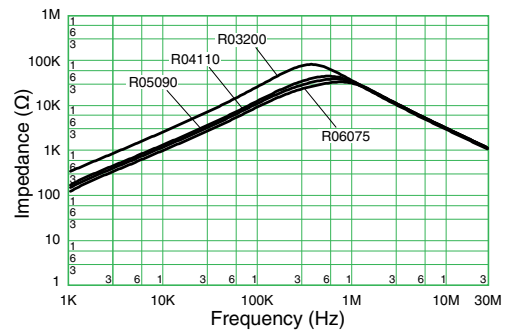
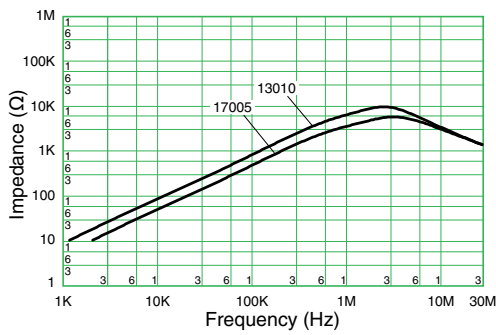
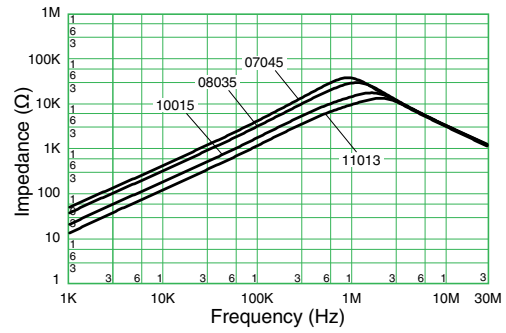
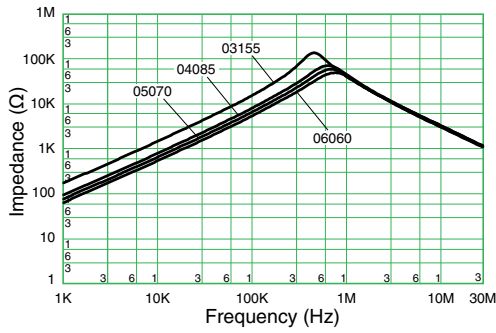

Frequency Characteristics cont.

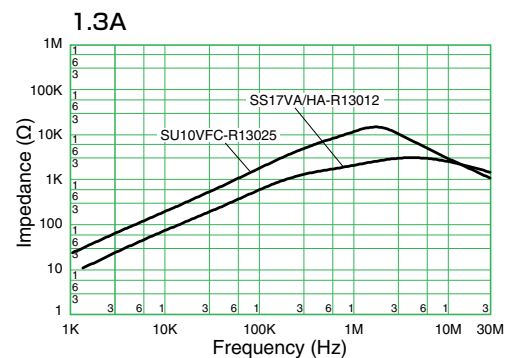
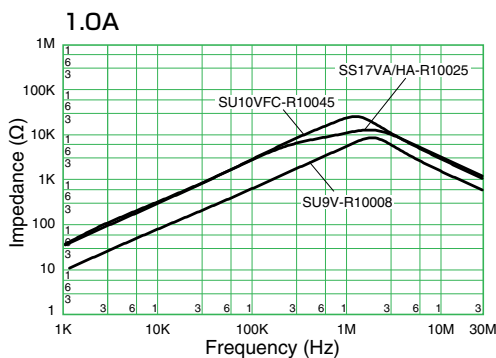
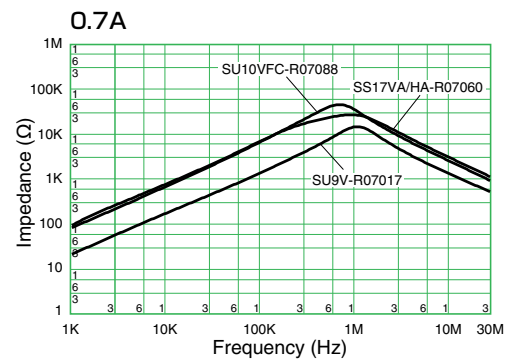
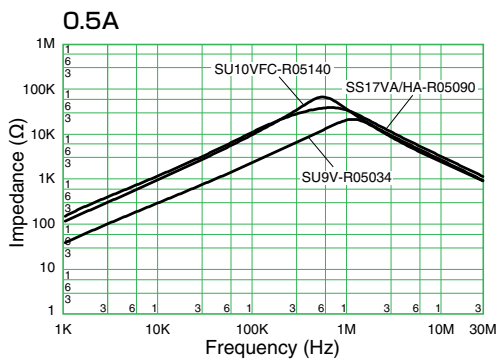
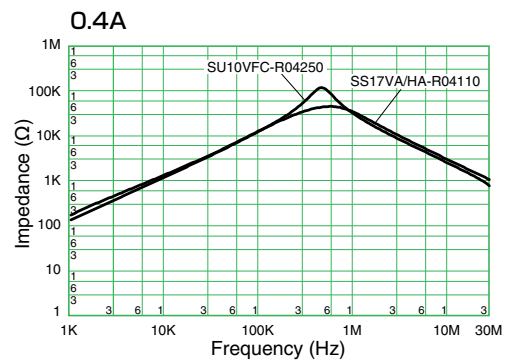
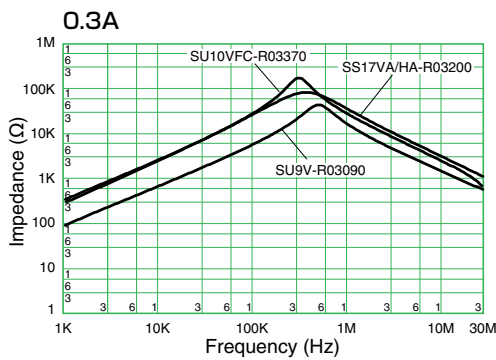
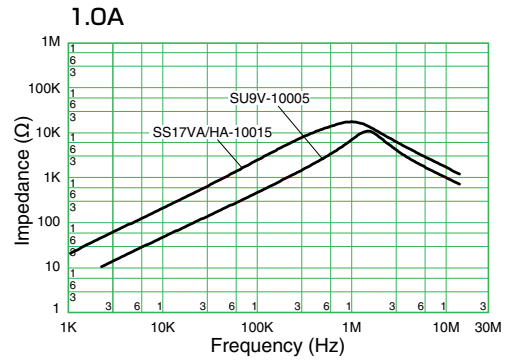
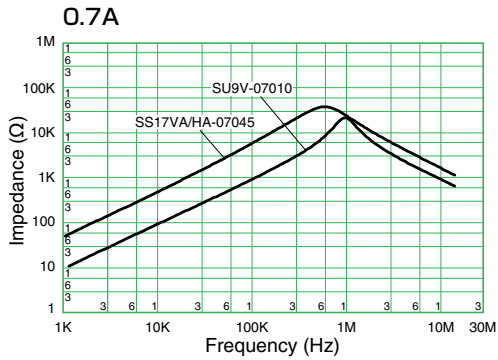

Frequency Characteristics cont.

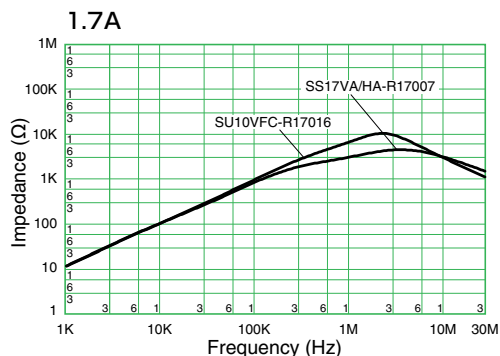

Handling Precautions

Precautions for product storage

AC Line Filters should be stored in normal working environments. While the chokes themselves are quite robust in other environments, solderability will be degraded by exposure to high temperatures, high humidity, corrosive atmospheres, and long term storage.

KEMET recommends that maximum storage temperature not exceed 40°C and maximum storage humidity not exceed 70% relative humidity. Atmospheres should be free of chlorine and sulfur bearing compounds. Temperature fluctuations should be minimized to avoid condensation on the parts. Avoid storage near strong magnetic fields, as this might magnetize the product.

For optimized solderability, AC line filters stock should be used promptly and preferably within 6 months of receipt.

Product temperature rise values

The values listed for temperature rise are the result of self-heating in wires when the rated current (commercial frequency) is applied.

When using the product, check and evaluate the value of the core temperature rise under actual operating conditions.

Export Control

For customers in Japan

For products that are controlled items subject to the “Foreign Exchange and Foreign Trade Law” of Japan, the export license specified by the law is required for export.

For customers outside Japan

AC line filters should not be used or sold for the use in the development, production, stockpiling, or utilization of any conventional weapons, mass-destruction weapons (nuclear, chemical, biological weapons, or missiles), or any other weapons.

KEMET Electronics Corporation Sales Offices

For a complete list of our global sales offices, please visit www.kemet.com/sales.

Disclaimer

YAGEO Corporation and its affiliates do not recommend the use of commercial, automotive, and/or COTS grade products for high reliability applications or manned space flight.

All product specifications, statements, information and data (collectively, the "Information") in this datasheet are subject to change. The customer is responsible for checking and verifying the extent to which the Information contained in this publication is applicable to an order at the time the order is placed. All Information given herein is believed to be accurate and reliable, but it is presented without guarantee, warranty, or responsibility of any kind, expressed or implied.

Statements of suitability for certain applications are based on KEMET Electronics Corporation's ("KEMET") knowledge of typical operating conditions for such applications, but are not intended to constitute – and KEMET specifically disclaims – any warranty concerning suitability for a specific customer application or use. The Information is intended for use only by customers who have the requisite experience and capability to determine the correct products for their application. Any technical advice inferred from this Information or otherwise provided by KEMET with reference to the use of KEMET's products is given gratis, and KEMET assumes no obligation or liability for the advice given or results obtained.

Although KEMET designs and manufactures its products to the most stringent quality and safety standards, given the current state of the art, isolated component failures may still occur. Accordingly, customer applications which require a high degree of reliability or safety should employ suitable designs or other safeguards (such as installation of protective circuitry or redundancies) in order to ensure that the failure of an electrical component does not result in a risk of personal injury or property damage.

Although all product-related warnings, cautions and notes must be observed, the customer should not assume that all safety measures are indicated or that other measures may not be required.

When providing KEMET products and technologies contained herein to other countries, the customer must abide by the procedures and provisions stipulated in all applicable export laws and regulations, including without limitation the International Traffic in Arms Regulations (ITAR), the US Export Administration Regulations (EAR) and the Japan Foreign Exchange and Foreign Trade Act.

KEMET is a registered trademark of KEMET Electronics Corporation.