

**A6 Series – Miniature Switches and Pilot Devices: 16mm**

**Key features:**

- 16mm (5/8") mounting hole
- LED illumination
- Compact design saves space
- Momentary, Maintained, Selectors, and E-Stops
- Gold-clad Silver contacts for reliable low level switching
- Snap action contacts
- IP40 (dustproof) or IP65 (oiltight) versions



UL Recognized  
File No. E55996



CSA Certified  
File No. LR21451



Specifications	Degree of Protection		IP40: Dustproof IP65 Watertight/Oiltight			
	Contact Configuration		SPDT, DPDT			
	Maximum Voltage		250V AC/DC			
	Thermal Current		3A			
	Minimum Applicable Load		5V AC/DC, 1mA			
	Contact Material		Gold-clad silver			
	Terminal Style		.110" Solder/ Quick Connect			
	Operating Temperature		-25° to +55°C (no freezing)			
	Operating Humidity		45 to 85% RH			
	Contact Resistance		50mΩ maximum (initial value)			
	Insulation Resistance		100MΩ minimum (500V DC megger)			
	Vibration Resistance		10 to 55Hz, amplitude 1.5mm p-p			
	Shock Resistance		Damage limits: 500m/sec <sup>2</sup> (approx. 50G) Operating extremes: 200m/sec <sup>2</sup> (approx. 20G)			
	Electrical Life		100,000 operations minimum (at full rated load)			
Contact Ratings	Operating Voltage		24V	120V	240V	
	AC (50/60Hz)	Resistive	—	1.0A	0.5A	
		Inductive	—	0.7A	0.5A	
	DC	Resistive	1.0A	0.2A	—	
Inductive		0.7A	0.1A	—		
LED Lamp Ratings	Rated Voltage/Current		5V DC ±5%	6V AC/DC (±10%)	12V AC/DC (±10%)	24V AC/DC (±10%)
			8mA	AC: A, R, W, Y: 8mA G, S: 7mA DC: A, R, W, Y: 6mA G, S: 5mA	AC: 9mA DC: 8mA	AC: 9mA DC: 8mA

1. AC Inductive Load, PF = 0.6 – 0.7; DC Inductive Load, L/R = 7ms.
2. LED lamp contains a built-in current limiting resistor and a protection diode.
3. LED's don't "burn out." Luminance is reduced to 50% of initial intensity after being lit for 50,000 hours continuously.

Switches & Pilot Devices

Signaling Lights

Relays & Sockets

Timers

Contactors

Terminal Blocks

Circuit Breakers

AB6 Non-Illuminated Pushbuttons (Assembled)

Non-Illuminated Pushbuttons

Style	Contact	Part Number			
		Momentary		Maintained (Latching)	
		Dustproof (IP40)	Oiltight (IP65)	Dustproof (IP40)	Oiltight (IP65)
Round 18mm 	SPDT DPDT	AB6M-M1-① AB6M-M2-①	AB6M-M1P-① AB6M-M2P-①	AB6M-A1-① AB6M-A2-①	AB6M-A1P-① AB6M-A2P-①
Square 18mm 	SPDT DPDT	AB6Q-M1-① AB6Q-M2-①	AB6Q-M1P-① AB6Q-M2P-①	AB6Q-A1-① AB6Q-A2-①	AB6Q-A1P-① AB6Q-A2P-①
Rectangular 18mm x 24mm 	SPDT DPDT	AB6H-M1-① AB6H-M2-①	AB6H-M1P-① AB6H-M2P-①	AB6H-A1-j AB6H-A2-j	AB6H-A1P-① AB6H-A2P-①
Round 23.5mm 	SPDT DPDT	-	AB6M-M1P-M② AB6M-M2P-M②	-	AB6M-A1P-M① AB6M-A2P-M①
Square 23.5mm 	SPDT DPDT	-	AB6Q-M1P-Q① AB6Q-M2P-Q①	-	AB6Q-A1P-Q① AB6Q-A2P-Q①
Rectangular 17.5 X 23.5mm 	SPDT DPDT	-	AB6Q-M1P-H① AB6Q-M2P-H①	-	AB6Q-A1P-H① AB6Q-A2P-H①

① Button Color Code

Color	Code
Black	B
Green	G
Red	R
Blue	S
White	W
Yellow	Y





1. In place of ① specify Button Color Code from the table at right.
2. To order as sub-assembled, see page 459.
3. For accessories, see page 466.
4. For dimensions, see page 468.

**AB6 Non-Illuminated Pushbuttons (Sub-Assembled)**









**Operators**

Style	Contact	Operator	Part Number		
			Round	Square	Rectangular
Non-Illuminated Pushbuttons 	SPDT	Momentary	AB6M-M100	AB6Q-M100	AB6H-M100
		Maintained	AB6M-A100	AB6Q-A100	AB6H-A100
	DPDT	Momentary	AB6M-M200	AB6Q-M200	AB6H-M200
		Maintained	AB6M-A200	AB6Q-A200	AB6H-A200

 Oversize rectangular button uses square operator.

**Buttons**

Description	Part Number	
	Button	
	Dustproof (IP40)	Oiltight (IP65)
Round 	AB6M-BK1-j	AB6M-BK2-j
Square 	AB6Q-BK1-j	AB6Q-BK2-j
Rectangular 	AB6H-BK1-j	AB6H-BK2-j
Round Oversize 	—	AB6M-BK2-Mj
Square Oversize 	—	AB6Q-BK2-Qj
Rectangular Oversize 	—	AB6Q-BK2-Hj

**① Button Color Code**

Color	Code
Black	B
Green	G
Red	R
Blue	S
White	W
Yellow	Y

-  1. In place of j, specify Button Color Code from table.
- 2. Buttons which are rated IP65 include a waterproof rubber gasket.
- 3. For accessories, see page 466.

AL6 Illuminated Pushbuttons (Assembled)

LED Illuminated Pushbuttons

Description	Style	Contact	Part Numbers			
			Momentary		Maintained (Latching)	
			Dustproof (IP40)	Oiltight (IP65)	Dustproof (IP40)	Oiltight (IP65)
Standard Lens	Round (18mm lens) 	SPDT DPDT	AL6M-M1③-② AL6M-M2③-②	AL6M-M1③P-② AL6M-M2③P-②	AL6M-A1③-② AL6M-A2③-②	AL6M-A1③P-② AL6M-A2③P-②
	Square (18mm lens) 	SPDT DPDT	AL6Q-M1③-② AL6Q-M2③-②	AL6Q-M1③P-② AL6Q-M2③P-②	AL6Q-A1③-② AL6Q-A2③-②	AL6Q-A1③P-② AL6Q-A2③P-②
	Rectangular (18mm x 24mm lens) 	SPDT DPDT	AL6H-M1①-② AL6H-M2①-②	AL6H-M1IP-② AL6H-M2IP-②	AL6H-A1①-② AL6H-A2①-②	AL6H-A1IP-② AL6H-A2IP-②
Oversize Lens	Round (24mm lens) 	SPDT DPDT	-	AL6M-M1③P-M② AL6M-M2③P-M②	-	AL6M-A1③P-M② AL6M-A2③P-M②
	Square (24mm lens) 	SPDT DPDT	-	AL6Q-M1③P-Q② AL6Q-M2③P-Q②	-	AL6Q-A1③P-Q② AL6Q-A2③P-Q②
	Rectangular (18mm x 24mm lens) 	SPDT DPDT	-	AL6Q-M1③P-H② AL6Q-M2③P-H②	-	AL6Q-A1③P-H② AL6Q-A2③P-H②

- 1. In place of ②, specify Lens/LED Color Code from table below.
- 2. In place of ③, specify Voltage Code from table below.
- 3. Lamps also available in 5V DC, 6V AC/DC or 12 V AC/DC, change "4" using voltage/lamp codes (ie AL6M-M13-k uses 12V AC/DC LED).
- 4. LED lamp is included in unit and contains a current-limiting resistor and a protection diode. (External resistor not required.)
- 5. To order as sub-assembled, see page.
- 6. For accessories, see page.
- 7. For dimensions, see page.
- 8. Light independent of switch position.

② Lens/LED Color Code

Color	Code
Amber	A
Green	G
Red	R
Blue	S
Warm White	W
Cool White	JW
Yellow	Y

③ Voltage Code

Voltage	Code
5V DC	1
6V AC/DC	2
12V AC/DC	3
24V AC/DC	4

AL6 Illuminated Pushbuttons (Sub-Assembled)















Operators

Style	Contact	Operator	Part Number		
			Round	Square	Rectangular
AL6 Illuminated Pushbuttons 	SPDT	Momentary	AL6M-M100	AL6Q-M100	AL6H-M100
		Maintained	AL6M-A100	AL6Q-A100	AL6H-A100
	DPDT	Momentary	AL6M-M200	AL6Q-M200	AL6H-M200
		Maintained	AL6M-A200	AL6Q-A200	AL6H-A200

 Oversize rectangular button uses square operator.

Lenses

Unit	Degree of Protection	Dustproof (IP40)	Part Number	
			Oiltight (IP65)	
			Standard	Oversize
Round	Standard	AL6M-LK1-k 	AL6M-LK2-⊙ 	AL6M-LK2-M k 
		AL6Q-LK1-k 	AL6Q-LK2-k 	AL6Q-LK2-Q k 
Square	Standard	AL6H-LK1-k 	AL6H-LK2-k 	AL6Q-LK2-H k 
		AL6Q-LK1-k 	AL6Q-LK2-k 	AL6Q-LK2-H k 

-  1. In place of ⊙, specify Lens Color Code from table below.
- 2. Lenses which are rated IP65 include a waterproof rubber gasket.
- 3. For accessories, see page.

Ⓜ Lens/LED Color Code

Color	Code
Amber	A
Green	G
Red	R
Blue	S
Warm White	W
Cool White	JW
Yellow	Y

LED Lamps

Appearance	Rated Voltage	Part Number
	5V DC	LATD-5 ⊙
	6V AC/DC	LATD-6 ⊙
	12V AC/DC	LATD-1 ⊙
	24V AC/DC	LATD-2 ⊙

 1. In place of ⊙, specify LED Color Code from table at left.

AL6 Pilot Lights (Assembled)

LED Pilot Lights

Description	Part Number	
	Dustproof (IP40)	Oiltight (IP65)
Round (18mm Lens) 	AL6M-P③-②	AL6M-P③P-②
Square (18mm Lens) 	AL6Q-P③-②	AL6Q-P③P-②
Rectangular (18mm x 24mm Lens) 	AL6H-P③-②	AL6H-P③P-②

- 1. In place of ②, specify Lens Color Code from table below.
- 2. In place of ③, specify Voltage Code from table below.
- 3. LEDs also available in 5V DC, 6V AC/DC or 12 V AC/DC, change "4" using voltage codes (ie AL6M-P3-② uses 12V AC/DC LED).
- 4. LED is included and contains built-in current limiting resistor and reverse polarity protection diode. (no external resistor required)
- 5. To order sub-assembled, see page.
- 6. For accessories, see page.
- 7. For dimensions, see page.
- 8. For one piece pilot lights and/or dome lens pilot lights, see AP series miniature pilot lights.

② Lens/LED Color Code

Color	Code
Amber	A
Green	G
Red	R
Blue	S
Warm White	W
Cool White	JW
Yellow	Y

③ Voltage Code

Voltage	Code
5V DC	1
6V AC/DC	2
12V AC/DC	3
24V AC/DC	4







AL6 Pilot Lights (Sub-Assembled)



Operators

Style	Part Number		
	Round	Square	Rectangular
AL6 Pilot Lights 	AL6M-P00	AL6Q-P00	AL6H-P00

Lenses

Degree of Protection	Part Number	
	Dustproof IP40	Oiltight IP65
Round	AL6M-LK1-Ⓢ 	AL6M-LK3-Ⓢ 
Square	AL6Q-LK1-Ⓢ 	AL6Q-LK3-Ⓢ 
Rectangular	AL6H-LK1-Ⓢ 	AL6H-LK3-Ⓢ 

- 1. In place of Ⓢ, specify Lens Color Code from table below.
- 2. Lenses which are rated IP65 include a waterproof rubber gasket.
- 3. For accessories, see page.

kLens/LED Color Code

Color	Code
Amber	A
Green	G
Red	R
Blue	S
Warm White	W
Cool White	JW
Yellow	Y

























LED Lamps

Appearance	Rated Voltage	Part Number
	5V DC	LATD-5 Ⓢ
	6V AC/DC	LATD-6 Ⓢ
	12V AC/DC	LATD-1 Ⓢ
	24V AC/DC	LATD-2 Ⓢ

- 1. In place of Ⓢ, specify LED Color Code from table at left.



AS6 Selector and Keylock Switches

AS6 Selector Switches and Keylock Switches (2 & 3 Position)

Style	Function	Knob	Knob	Key
Round Selector 	2-Position 90° Maintained		AS6M-2Y2P	AS6M-2KT2PⓈ
	2-Position 90° Spring Return Right		AS6M-21Y2P	AS6M-21KT2PB
Round Keylock 	3-Position 45° Maintained		AS6M-3Y2P	AS6M-3KT2PⓈ
	3-Position 45° Spring Return Right → Center		AS6M-31Y2P	AS6M-31KT2PⓈ
	3-Position 45° Spring Return Left → Center		AS6M-32Y2P	AS6M-32KT2PⓈ
	3-Position 45° 2-Way Return → Center		AS6M-33Y2P	AS6M-33KT2PD
	3-Position 45° 2-Way Return → Center		AS6M-33Y2P	AS6M-33KT2PD
Square Selector 	2-Position 90° Maintained		AS6Q-2Y2P	AS6Q-2KT2PⓈ
	2-Position 90° Spring Return to Right		AS6Q-21Y2P	AS6Q-21KT2PB
Square Keylock 	3-Position 45° Maintained		AS6Q-3Y2P	AS6Q-3KT2PⓈ
	3-Position 45° Spring Return Right → Center		AS6Q-31Y2P	AS6Q-31KT2PⓈ
	3-Position 45° Spring Return Left → Center		AS6Q-32Y2P	AS6Q-32KT2PⓈ
	3-Position 45° 2-Way Return → Center		AS6Q-33Y2P	AS6Q-33KT2PD
Rectangular Selector 	2-Position 90° Maintained		AS6H-2Y2P	AS6H-2KT2PⓈ
	2-Position 90° Spring Return Right		AS6H-21Y2P	AS6H-21KT2PB
Rectangular Keylock 	3-Position 45° Maintained		AS6H-3Y2P	AS6H-3KT2PⓈ
	3-Position 45° Spring Return Right → Center		AS6H-31Y2P	AS6H-31KT2PⓈ
	3-Position 45° Spring Return Left → Center		AS6H-32Y2P	AS6H-32KT2PⓈ
	3-Position 45° 2-Way Return → Center		AS6H-33Y2P	AS6H-33KT2PD

Contact Operations

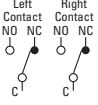
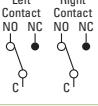
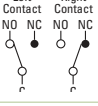
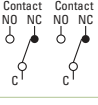
(for all selectors)

Contents	Operator Position & Contact Operation	
2-pos. (DPDT)	Left	
	Right	
3-pos. (DPDT)	Left	
	Center	
	Right	

Key Retention Codes

Code	Description
A	Key not retained in any position (removable in all positions)
B	Key retained in right position only
C	Key retained in left position only
D	Key retained in left and right (3 position only)
E	Key retained in center only (3 position only)
G	Key retained right and center (3 position only)
H	Key retained left and center (3 position only)

 Key cannot be removed in a spring return position.

-  All models are IP65 and DPDT.
- In place of Ⓢ, specify Key Retention Code. See table on right.
- Available as assembled units only.
- For accessories, see page 466.
- For dimensions, see page 468.



Switch Engraving Order Form – A6 Series

Copy this order form and use it to specify Letter Height, Maximum Number of Lines and Text to be engraved.

To insure engraving accuracy, fax it to your IDEC representative or Distributor.

Your Company:	_____	Telephone:	_____
Name:	_____	Fax:	_____
Address:	_____	Email:	_____
PO:	_____	Part Number to be Engraved:	_____

Please check one of the boxes below to indicate your choice of engraving options:

Rectangular Switch

	# of Lines	Letter Height	Max. Characters Per Line
<input type="checkbox"/>	1	5/32	6
<input type="checkbox"/>	2	5/32	6
<input type="checkbox"/>		1/8	6
<input type="checkbox"/>	3	1/8	6
<input type="checkbox"/>	4	N/A	

Square Switch

	# of Lines	Letter Height	Max. Characters Per Line
<input type="checkbox"/>	1	5/32	5
<input type="checkbox"/>	2	5/32	5
<input type="checkbox"/>		1/8	6
<input type="checkbox"/>	3	1/8	6
<input type="checkbox"/>	4	N/A	

Round Switch

	# of Lines	Letter Height	Max. Characters Per Line
<input type="checkbox"/>	1	5/32	3
<input type="checkbox"/>		1/8	3
<input type="checkbox"/>	2	5/32	Custom*
<input type="checkbox"/>	3	1/8	Custom*
<input type="checkbox"/>	4	3/32	Custom*

\*Engraving is possible, but character size will be smaller than standard sizes.



1. Engraving is done on the button itself for non-illuminated pushbuttons and on marking plate for illuminated pushbuttons and pilot lights.
2. Please enter text exactly how you want it engraved, take care to emphasize capital or small letters.

Enter text to be engraved

:

Line 1: \_\_\_\_\_

Line 2: \_\_\_\_\_

Line 3: \_\_\_\_\_

Line 4: \_\_\_\_\_

Sample Letter Sizes

1/8 Letters: OPEN

5/32 Letters: OPEN

For IDEC Internal Use Only:

Work Order #: \_\_\_\_\_

Accessories

Appearance		Description	Used With	Part Number
Locking Ring Wrench		Made of metal. Used for tightening plastic locking ring during installation. Tightening torque should not exceed 3kgf-cm	Ø 5/8" (16mm) units	MT-001
			Ø 31/64" (12mm) AP2M units	MT-002
			Ø 13/32" (10mm) AP1M units	MT-003
Lens Removal Tool		Made of metal. Used for removing lens or button from the housing	All pushbuttons and pilot lights	MT-101
Lamp Holder Tool		Made of rubber. Used for removing and replacing LED lamps in illuminated units	All illuminated pushbuttons and pilot lights	OR-77
Switch Guard		Prevents inadvertent switch operation. IP40 dust-tight. 90 degrees opening maintained	Round/Square	AL-K6
			Rectangular	AL-KH6
			Round/Square	AL-K6SP
			Rectangular	AL-KH6SP
Terminal Cover		Made of translucent nylon. Fits over and shields the terminals	All 5/8" (16mm) units	AL-V6
Dust Cover		Fits over the lens or button to provide extra protection from dust (not applicable for oversize lenses or buttons).	All round units	AL-D6
			All square units	AL-DQ6
			All rectangular units	AL-DH6
Adaptor Socket		Plug-on terminal adaptor with solder terminals		AL-C6
		Plug-on terminal adaptor with PCB terminals	All 5/8" (16mm) units	AL-C6V
Mounting Hole Plug		Fills unused panel cutouts. Made of nitrile rubber. Push-in installation from front of panel. IP65 (oiltight).	Rubber	AL-B6
		Fills unused panel cutouts. Made of aluminum. Screw-on locking ring from inside of panel. IP65 (oiltight).	Aluminum	AL-BM6
		Round Mounting Hole Plug	Plastic (Applicable for flush mount switches only)	LA9Z-BS6
		Square Mounting Hole Plug		LA9Z-BS7
		Rectangular Mounting Hole Plug		LA9Z-BS8
Replacement LED Lamps		LED with built in current limiting resistor (with all illuminated assemblies).	5V DC	LATD-5 ©
			6V AC/DC	LATD-6 ©
			12V AC/DC	LATD-1 ©
			24V AC/DC	LATD-2 ©
Replacement Locking Ring		Fastens operators to panel (included with all operators).	All switches & pilot lights	HA9Z-LN
Anti-Rotation Ring		Prevents rotation of switches in panel (included with all operators).	All switches & pilot lights	AL6-LP
Replacement Engraving Inserts		Engraving plates to allow legends underneath translucent lenses (included with all lenses).	Round standard	AL6M-W
			Square standard	AL6Q-W
			Rectangular standard	AL6H-W
			Round oversize	AL6M-MW
			Square/rectangular oversize	AL6Q-QW
Replacement Keys		Pair of keys (#132). All key switches use same standard key.	All key selectors	AS6-SK

1. In place of © specify color code. A=Amber, G=Green, Y=Yellow, R=Red, S=Blue, W=Warm White, JW=Cool White.  
2. LEDs include built-in current limiting resistor and reverse polarity protection diode.

Appearance		Description	Used With	Part Number
Flush Bezel		ø24mm round, metal (aluminum color), panel cut-out ø20.2mm	Pushbuttons, pilot lights, illuminated pushbutton, selector switches, key selector switches and illuminated selector switches.	LA9Z-SM61
		ø24mm round, plastic (black), square panel cut-out ø20.2mm		LA9Z-S61B
		24mm square, plastic (black), panel cut-out 20.2 x 20.2mm	A6 Switch +	LA9Z-S71B
		24 x 30mm rectangular, plastic (black), rectangular panel cut-out ø20.2 x 26.2mm	Flush Bezel =	LA9Z-S81B
Switch Guard w/ Flush Bezel (spring return)		Rectangular, plastic (black)	Flush Switch	LA9Z-KS8

Schematics — A Series: 5/8" (16mm)

Terminal Arrangement (Top View)

Illuminated Pushbuttons

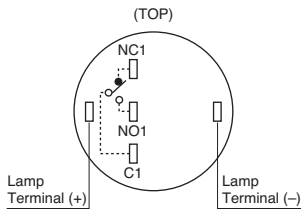

SPDT Contact  
(Single-pole/Double Throw)

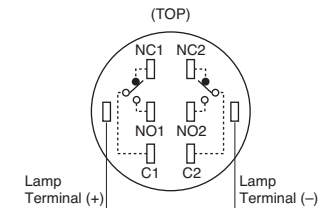

DPDT Contact  
(Double-pole/Double Throw)

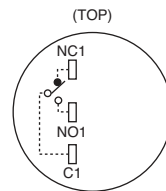

SPDT Contact  
(Single-pole/Double Throw)

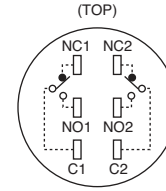

DPDT Contact  
(Double-pole/Double Throw)

Pilot Lights

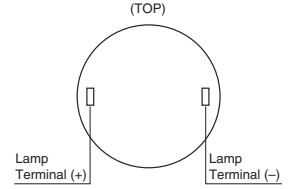

IDEC's Superbright LED Internal Circuits

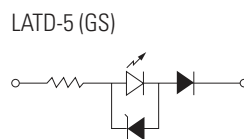
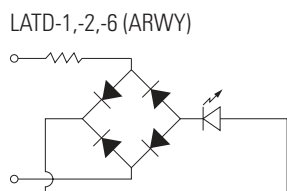
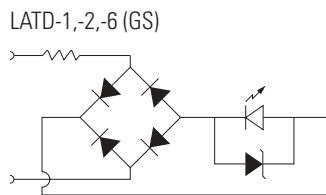

Switches & Pilot Devices

Signaling Lights

Relays & Sockets

Timers

Contactors

Terminal Blocks

Circuit Breakers

Dimensions (mm)

Pushbuttons, Ø 5/8" (16mm)

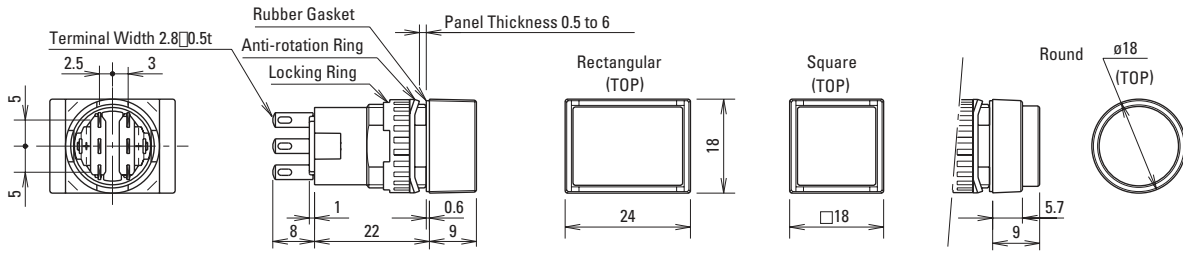

Oversize Lens

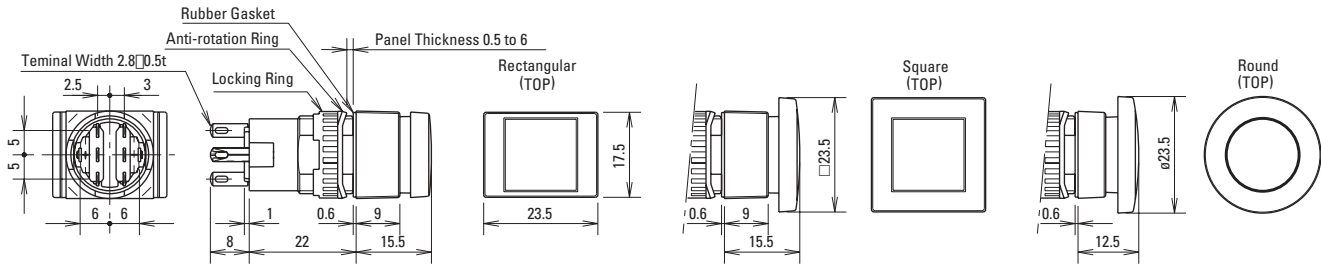

Selector Switches, Ø 5/8" (16mm)

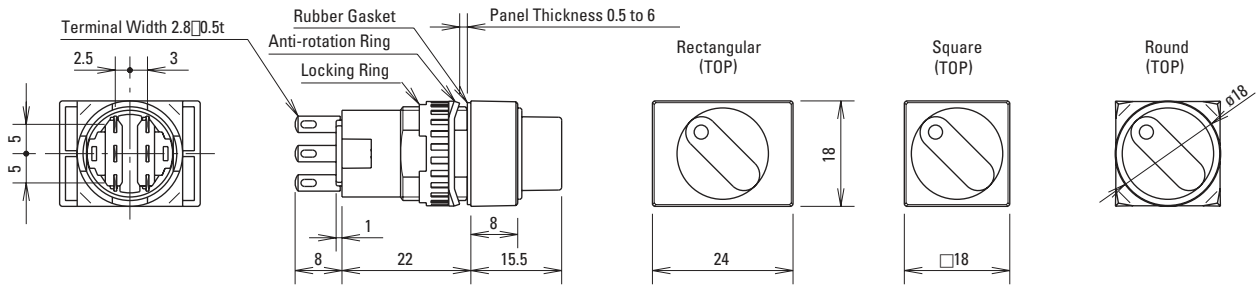

Key Selector Switches, Ø 5/8" (16mm)

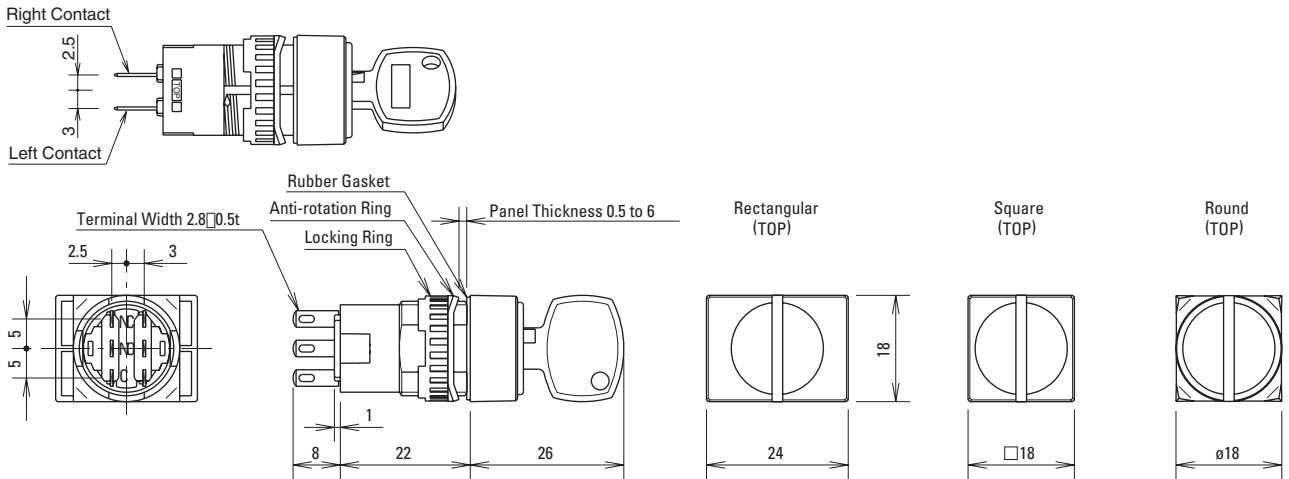

All dimensions are in mm.

Switch Guard, Ø 5/8" (16mm)

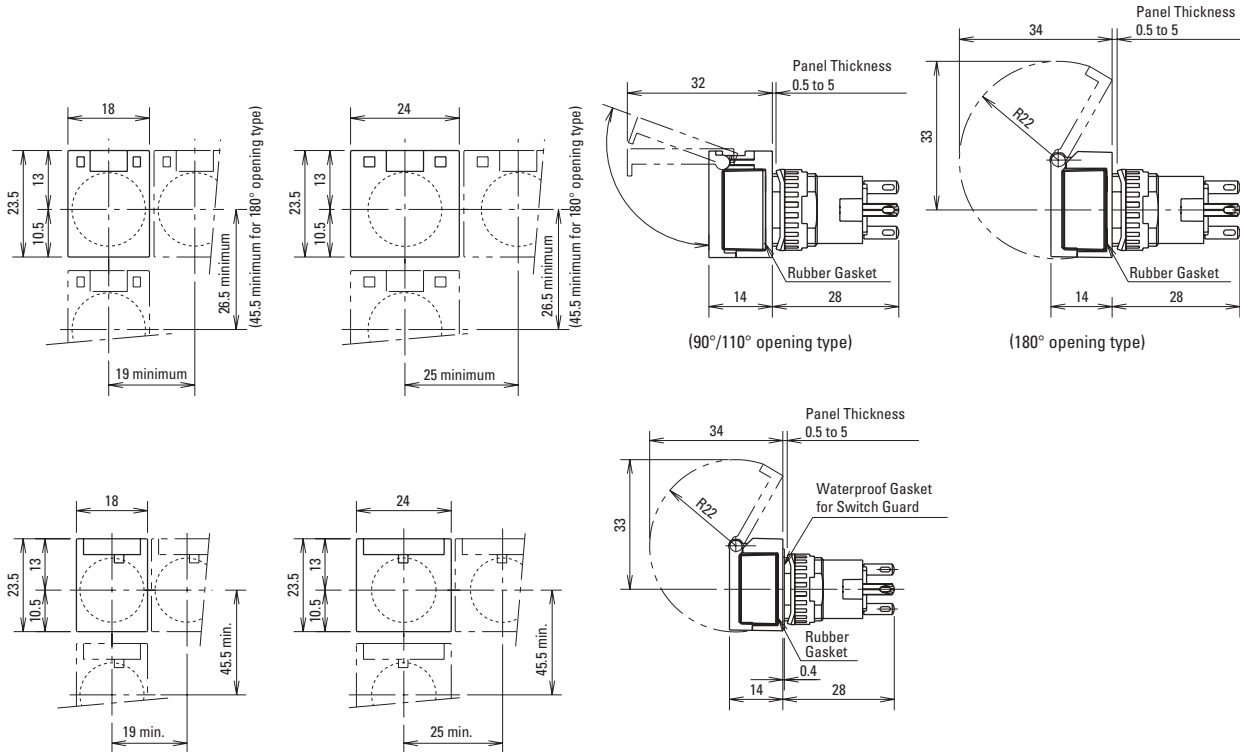

Flush Bezel

Flush Bezel with Switch

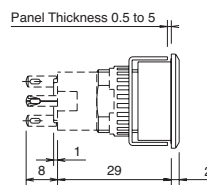
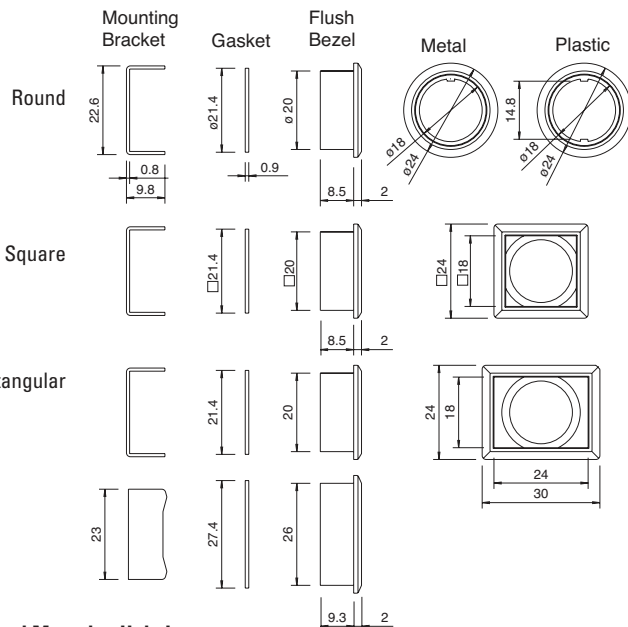

Selector Switches  
Illuminated &  
Non-illuminated

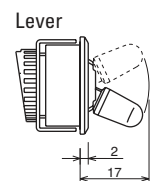
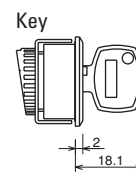

Flush Bezel Mounting Hole Layout

Round

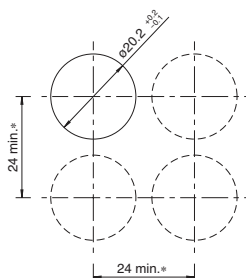

Square

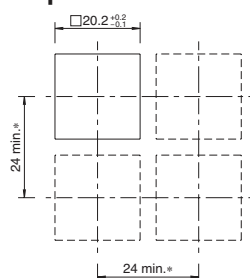

Rectangular

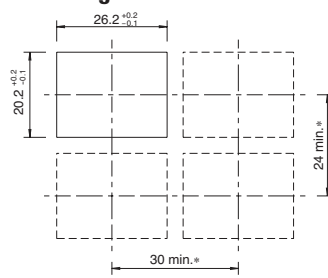

Switches & Pilot Devices

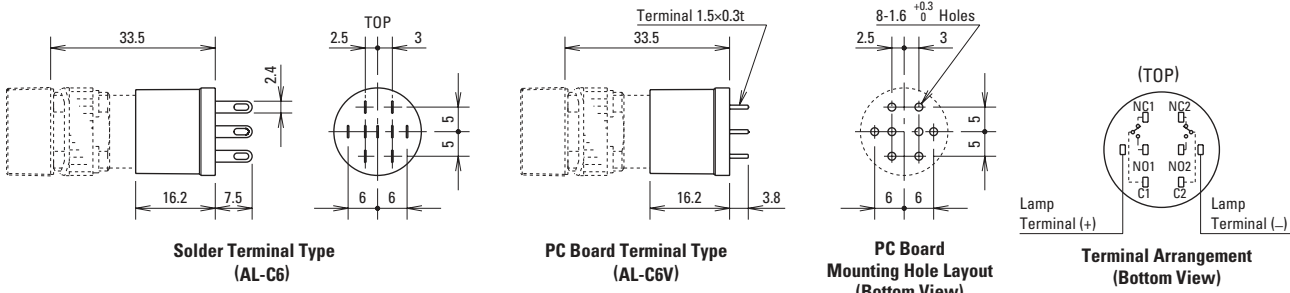

Signaling Lights

**Terminal Sockets Dust Covers**

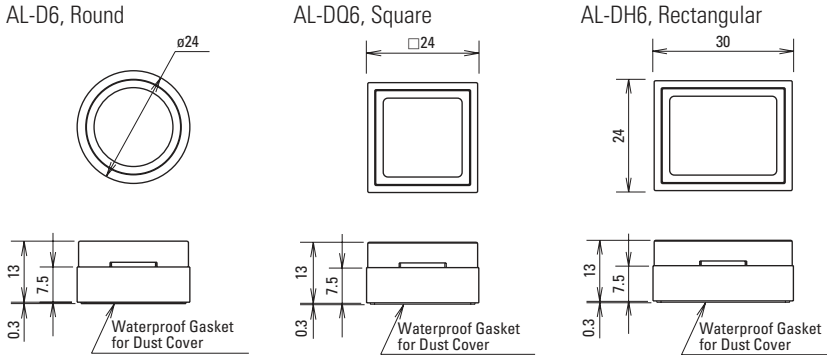

Relays & Sockets

**Panel Cut-Outs For Units w/Dust Cover**

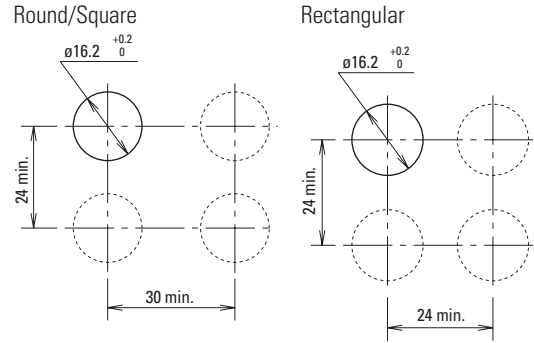

Timers

**Pushbuttons with Standard Size Lens**

Style	Round—AL6M-W	Square—AL6Q-W	Rectangular—AL6H-W
Dimensions			
Outside (OD)	Ø 5/8" (16mm)	(13.8mm)	(OD <sup>1</sup> x OD <sup>2</sup> ) 13.8 x 19.8mm
Marking Area (a)	(12mm)	(12mm)	(a <sup>1</sup> x a <sup>2</sup> ) 12 x 18mm

Engraving must be made on the engraving area within 0.02" (0.5mm) deep.

**Pushbuttons with Oversize Lens**

Style	Round—AL6M-MW	Square/Rectangular—AL6Q-QW
Dimensions		
Outside (OD)	Ø 0.491" (12.6mm)	0.491" (12.6mm)
Marking Area (a)	Ø 0.429" (11mm)	0.429" (11mm)

Contactors

**Replacing and Marking Plate**

**Removal**

Remove the lens holder assembly (lens, marking plate and holder) from the operator by holding the color lens recesses with the lens removal tool (Part No.MT-101) and pulling out. Remove marking plate by pushing the color lens from the rear to disengage the latches. Marking plate must be engraved on the side as shown in the figure on the right.  
 Ø 5/8" (16mm)

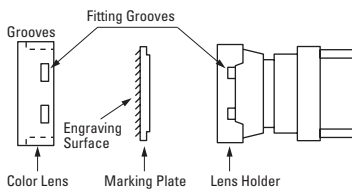

**Installation**

For illuminated pushbuttons:

1. Insert marking plate inside lens in correct direction
2. Press color lens on to lens holder to engage latches.
3. Insert lens holder into housing in correct direction.

Do not loosen spring on illuminated pushbutton units (except on pilot light units). The marking plate must be engraved on the front side as shown above.

Terminal Blocks

Circuit Breakers