

THIS IS A C.A.D. GENERATED DRAWING
DO NOT MAKE MANUAL REVISIONS TO MASTER.

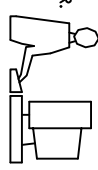

ISSUE NUMBER
ORIGINAL
①

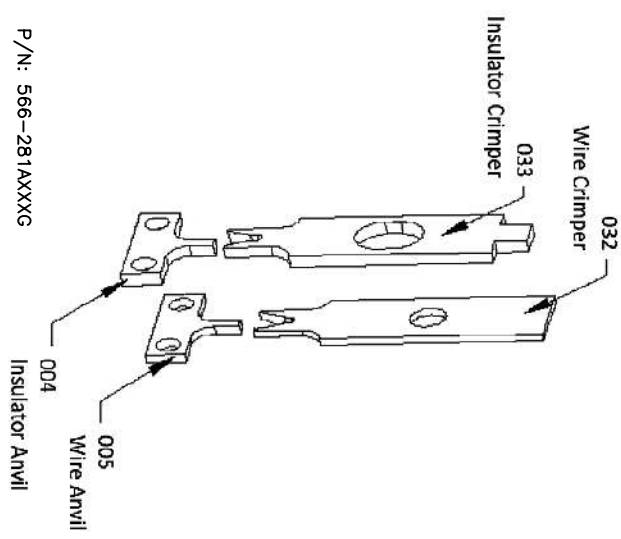
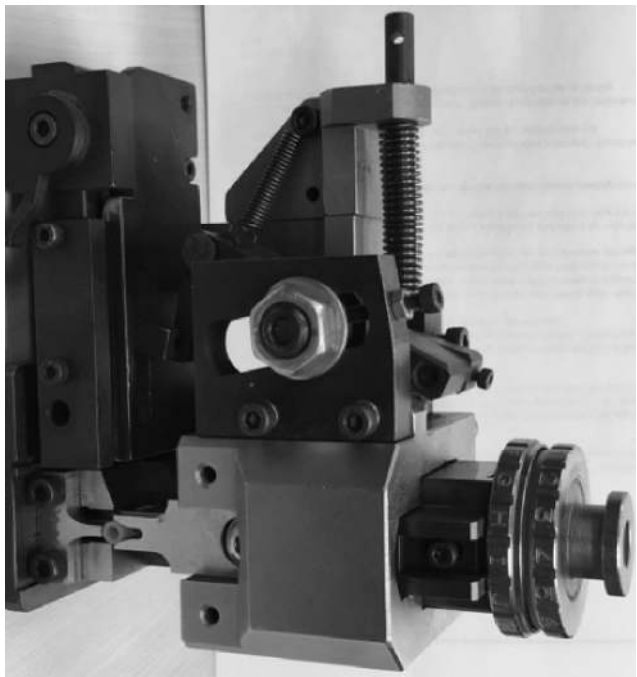

PRESS TYPE	G PRESS
STROKE LENGTH	40.00 MM
SHUT HEIGHT	135.79 MM
AWG	20-28

REPLACEMENT PUNCH & DIE PARTS			
INSULATOR ANVIL	WIRE ANVIL	WIRE CRIMPER	INSULATOR CRIMPER
566-281A004G	566-281A005G	566-281A032G	566-281A033G

- NOTES:
- 1- THIS APPLICATOR IS DESIGNED TO BE USED ON A G CRIMPING MACHINE.
 - 2- THIS APPLICATOR IS DESIGNED FOR CRIMPING EDAC CONTACT P/N 566-290-711.
 - 3- FOR THE DEFINITION OF STROKE LENGTH AND SHUT HEIGHT, APPLICATOR SETUP AND OPERATING INSTRUCTION, PLEASE REFER TO DOCUMENT "APPLICATOR INSTRUCTION MANUAL G PRESS".

G PRESS APPLICATOR FOR 566-290-711		ACAD REFERENCE NO. 566-280-751G
DRAWN: K.L.		DATE: OCT.29/2020
CHECKED: R.S.M.		DATE: OCT.29/2020
SCALE: N.T.S.	SHEET 1 OF 1	
DRAWING NUMBER	ISSUE	
566-280-751G	1	

EDAC INC
TORONTO, ONTARIO
CANADA

YOUR CONNECTION TO QUALITY & SERVICE

THESE DRAWINGS AND SPECIFICATIONS ARE THE PROPERTY OF EDAC INC. AND SHALL NOT BE REPRODUCED, OR COPIED OR USED AS THE BASIS FOR THE MANUFACTURE OR SALE OF APPARATUS WITHOUT WRITTEN PERMISSION.