

40.0 x 7.0 x 3.0 (mm) LTE Full-Band Chip Antenna (CC40D7J) Engineering Specification

1. Product Number

H
2
U
E
6
Q
1
K
2
G
0
1
0
0



2. Features

- * Compatible with LTE full-band/ 3G/ 2G
- * Stable and reliable in performances
- * Compact size
- * RoHS2.0 compliance
- * SMT processes compatible

3. Applications

- * LTE full-band/ 3G/ 2G.
- * LTE / GSM / CDMA /DCS /PCS / WCDMA / UMTS / HSDPA / GPRS / EDGE /IMT.

4. Description

Unictron's CC40D7J chip antenna is designed for cellular 2G/ 3G/ LTE bands applications, covering frequencies 698~960 MHz & 1710~2690 MHz. Fabricated with proprietary design and processes, CC40D7J shows excellent performance and is fully compatible with SMT processes which can decrease the assembly cost and improve device's quality and consistency.



詠業科技股份有限公司
 Unictron Technologies Corporation
 Website:www.unictron.com

THIS DRAWINGS AND SPECIFICATIONS ARE THE PROPERTY OF UNICTRON TECHNOLOGIES CORPORATION AND SHALL NOT BE REPRODUCED OR USED AS THE BASIS FOR THE MANUFACTURE OR SALE OF APPARATUS OR DEVICES WITHOUT PERMISSION

Prepared by : **Betty**

Designed by : **Sam**

Checked by : **Mike**

Approved by : **Herbert**

**TITLE : 40.0 x 7.0 x 3.0 (mm) LTE Full-Band Chip
Antenna (CC40D7J) Engineering Specification**

**DOCUMENT
NO.**

H2UE6Q1K2G0100

**REV.
F**

5. Layout Guide & Electrical Specifications

5-1. Layout Guide (Unit: mm)

Solder Land Pattern:

The solder land pattern (gold marking areas) is shown below. Recommendation on matching circuit will be provided according to customer's installation conditions.

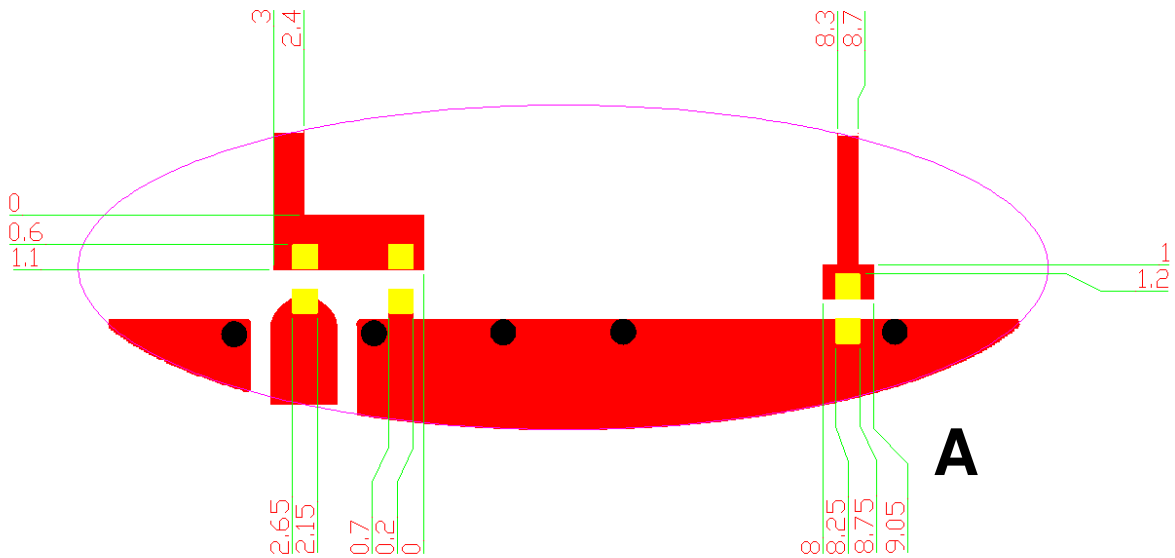
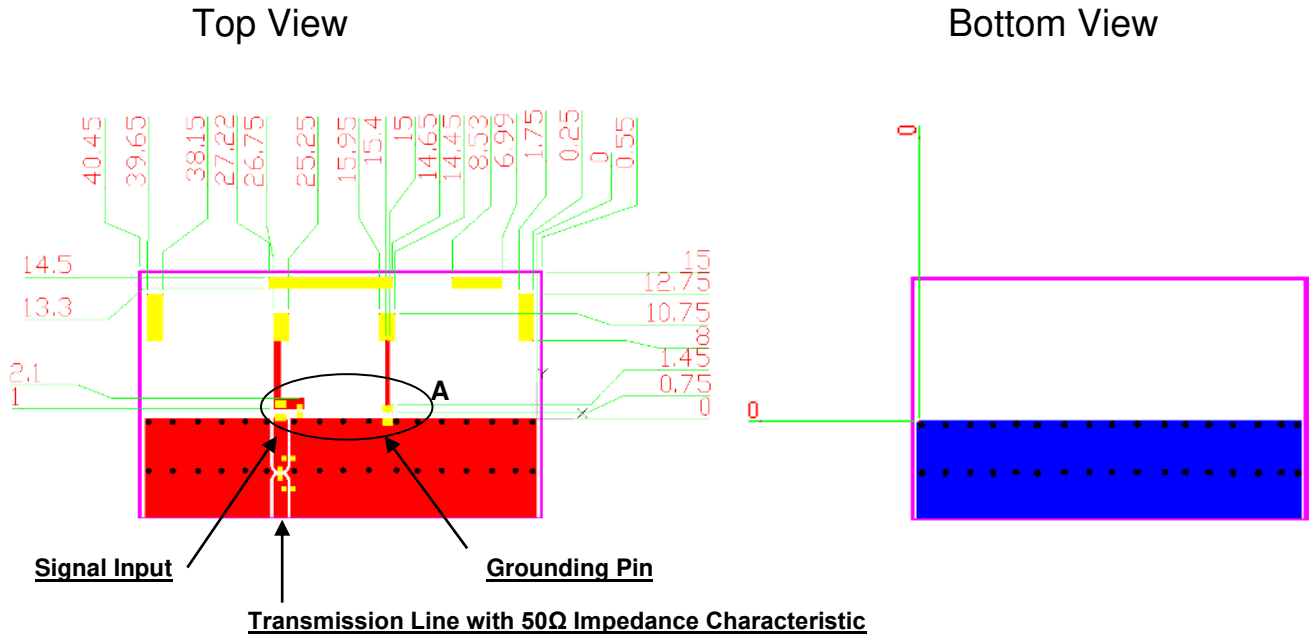

詠業科技股份有限公司
Unictron Technologies Corporation
Website: www.unictron.com

THIS DRAWINGS AND SPECIFICATIONS ARE THE PROPERTY OF UNICTRON TECHNOLOGIES CORPORATION AND SHALL NOT BE REPRODUCED OR USED AS THE BASIS FOR THE MANUFACTURE OR SALE OF APPARATUS OR DEVICES WITHOUT PERMISSION

Prepared by : Betty

Designed by : Sam

Checked by : Mike

Approved by : Herbert

TITLE : 40.0 x 7.0 x 3.0 (mm) LTE Full-Band Chip
Antenna (CC40D7J) Engineering Specification

DOCUMENT
NO.

H2UE6Q1K2G0100

REV.
F

5-2. Electrical Specifications (with 135 x 41 mm² Evaluation Board)

5-2-1. Electrical Table

Characteristics	Specifications				
Outline Dimension (mm)	40.0 x 7.0 x 3.0				
Ground Plane Dimension (mm)	119.4 x 41				
Working Frequency (MHz)	698 ~ 798	824 ~ 960	1710 ~ 2170	2300 ~ 2400	2490 ~ 2690
Peak Gain (dBi) (typical)**	2.3	2.1	6.4	6.8	5.8
Efficiency (%) (typical)**	67	67	76	77	74
VSWR (@ center frequency)*	< 5 : 1		< 3.5 : 1		
Characteristic Impedance (Ω)	50				
Polarization	Linear Polarization				

*Center frequency means the frequency with the lowest value in return loss of the chip antenna on the evaluation board.

**A typical value is for reference only, not guaranteed.

5-2-2. Frequency vs. V.S.W.R. and Total Radiation Gain

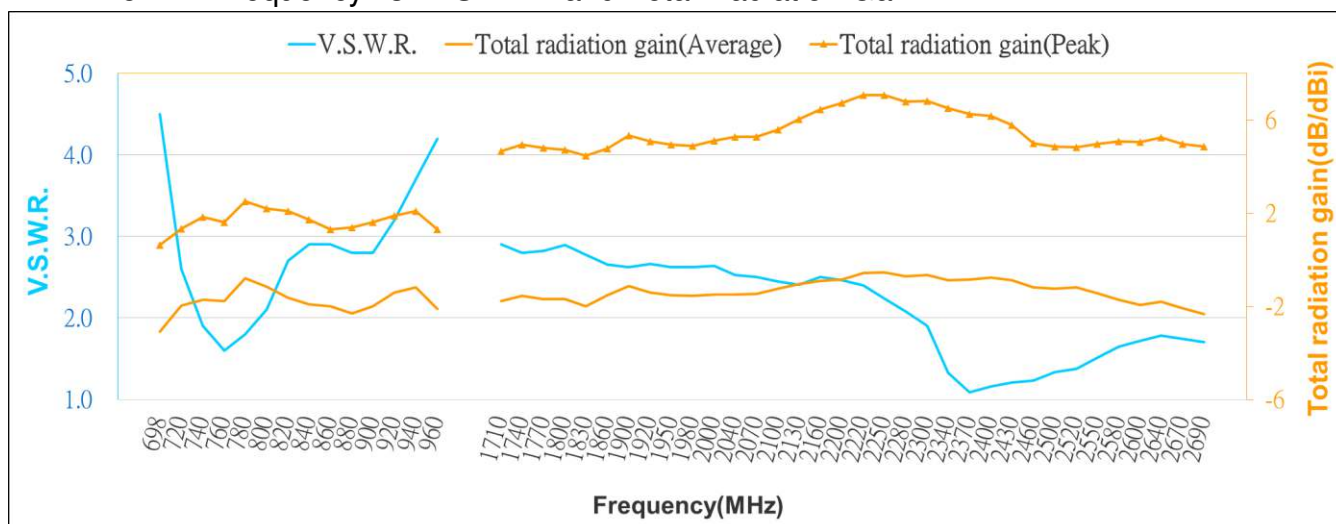

詠業科技股份有限公司
Unictron Technologies Corporation
Website: www.unictron.com

THIS DRAWINGS AND SPECIFICATIONS ARE THE PROPERTY OF UNICTRON TECHNOLOGIES CORPORATION AND SHALL NOT BE REPRODUCED OR USED AS THE BASIS FOR THE MANUFACTURE OR SALE OF APPARATUS OR DEVICES WITHOUT PERMISSION

Prepared by : Betty

Designed by : Sam

Checked by : Mike

Approved by : Herbert

TITLE : 40.0 x 7.0 x 3.0 (mm) LTE Full-Band Chip
Antenna (CC40D7J) Engineering Specification

DOCUMENT
NO.

H2UE6Q1K2G0100

REV.
F

6. Outline Dimensions of Antenna & Evaluation Board (Unit: mm)

6-1. Antenna Dimensions

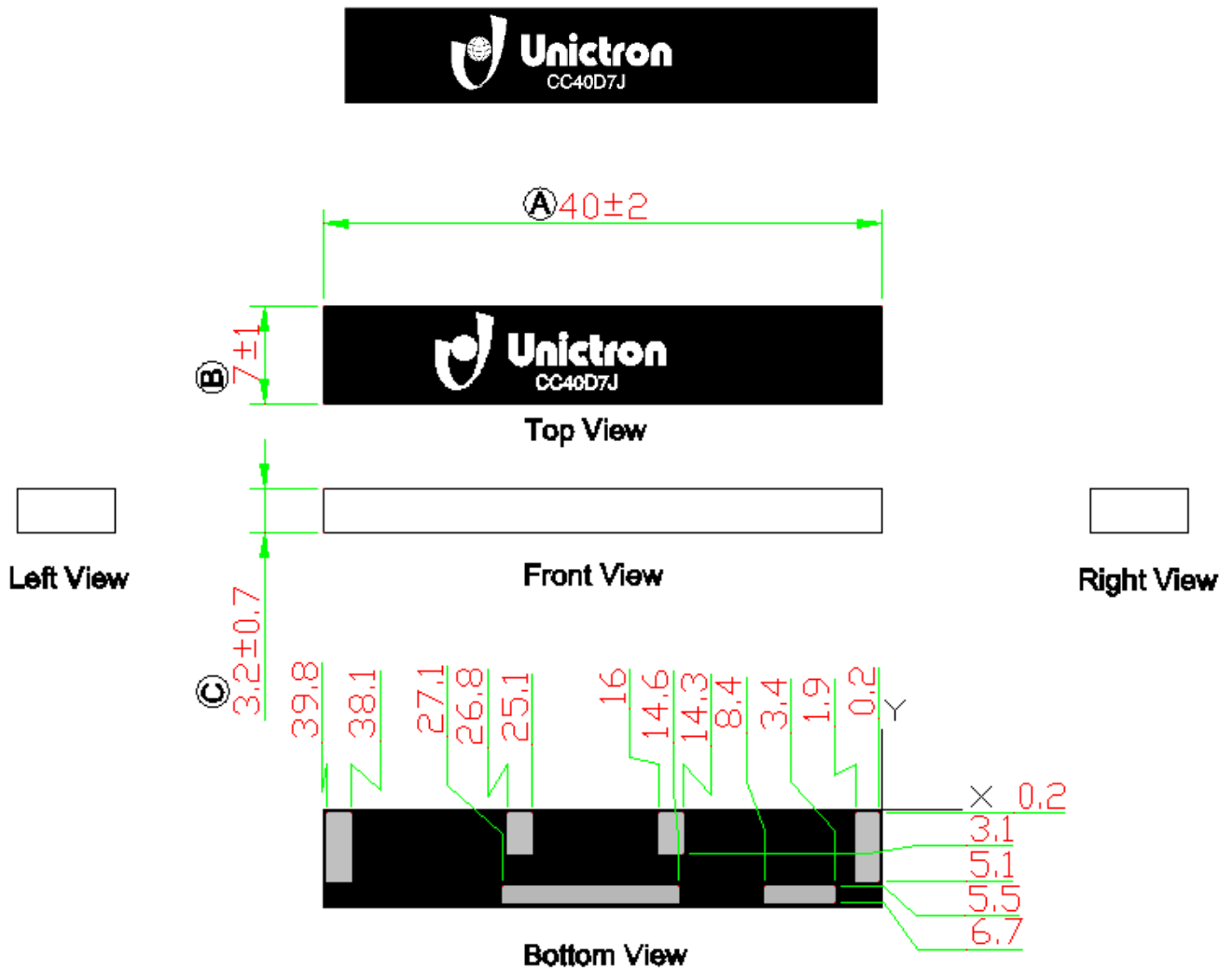

NOTE:

1. All materials are RoHS 2.0 compliant.
2. "A~C" Critical Dimensions.
3. "()" Reference Dimensions.



詠業科技股份有限公司
 Unictron Technologies Corporation
 Website: www.unictron.com

THIS DRAWINGS AND SPECIFICATIONS ARE THE PROPERTY OF UNICTRON TECHNOLOGIES CORPORATION AND SHALL NOT BE REPRODUCED OR USED AS THE BASIS FOR THE MANUFACTURE OR SALE OF APPARATUS OR DEVICES WITHOUT PERMISSION

Prepared by : Betty

Designed by : Sam

Checked by : Mike

Approved by : Herbert

TITLE : 40.0 x 7.0 x 3.0 (mm) LTE Full-Band Chip
 Antenna (CC40D7J) Engineering Specification

DOCUMENT NO.

H2UE6Q1K2G0100

REV.
F

PIN Definition

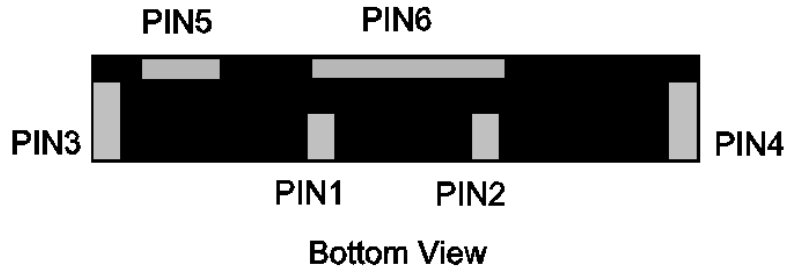

PIN	1	2	3~6
Soldering Pad	Tuning/Ground	Signal	N/C

6-2. Evaluation Board & Antenna Location

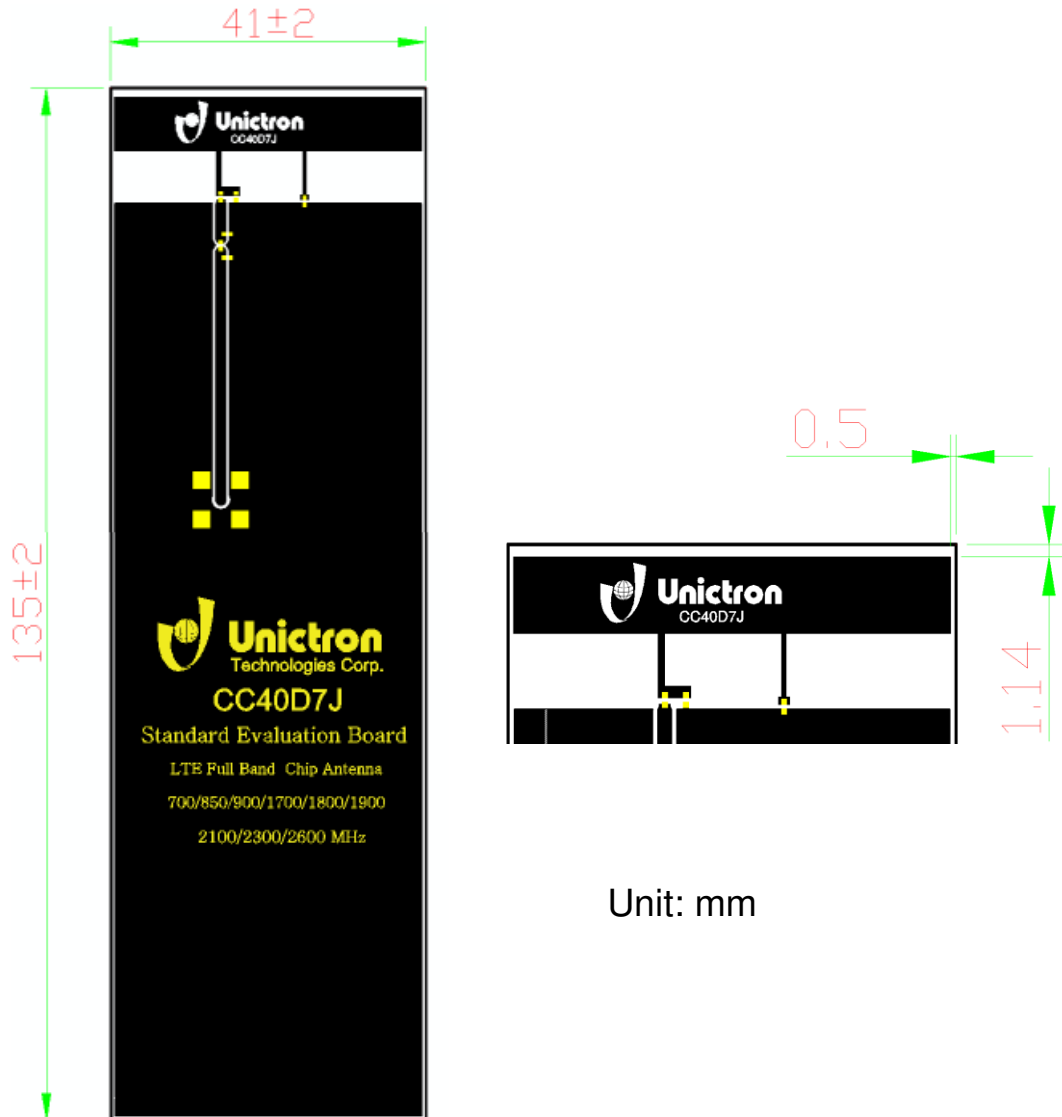

詠業科技股份有限公司
 Unictron Technologies Corporation
 Website: www.unictron.com

THIS DRAWINGS AND SPECIFICATIONS ARE THE PROPERTY OF UNICTRON TECHNOLOGIES CORPORATION AND SHALL NOT BE REPRODUCED OR USED AS THE BASIS FOR THE MANUFACTURE OR SALE OF APPARATUS OR DEVICES WITHOUT PERMISSION

Prepared by : **Betty**

Designed by : **Sam**

Checked by : **Mike**

Approved by : **Herbert**

TITLE : 40.0 x 7.0 x 3.0 (mm) LTE Full-Band Chip Antenna (CC40D7J) Engineering Specification

DOCUMENT NO.

H2UE6Q1K2G0100

REV.
F

7. 3D Radiation Gain Pattern (with 135 x 41 mm² Evaluation Board)

7-1. 698~798MHz Band

3D Radiation Gain Pattern @ 748 MHz (Unit: dBi)

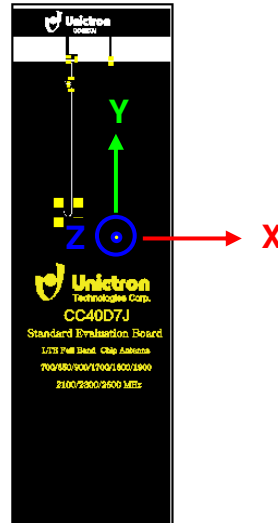
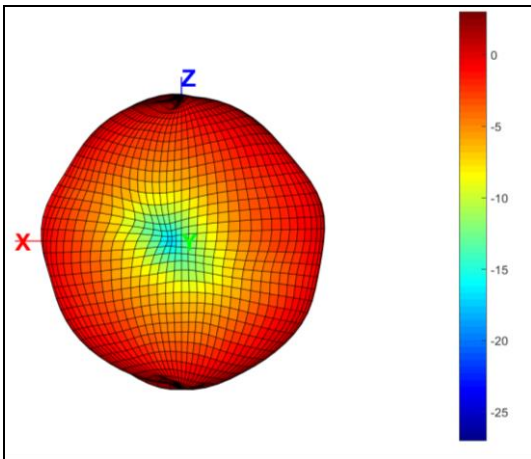
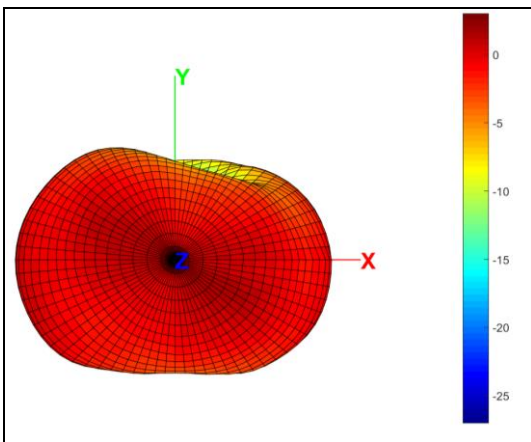
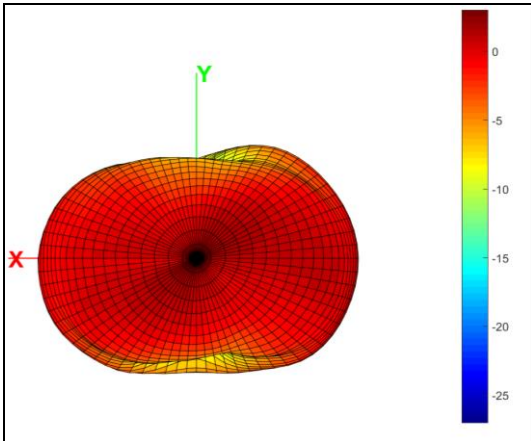

詠業科技股份有限公司
Unicon Technologies Corporation
Website: www.unicon.com

THIS DRAWINGS AND SPECIFICATIONS ARE THE PROPERTY OF UNICTRON TECHNOLOGIES CORPORATION AND SHALL NOT BE REPRODUCED OR USED AS THE BASIS FOR THE MANUFACTURE OR SALE OF APPARATUS OR DEVICES WITHOUT PERMISSION

Prepared by : Betty

Designed by : Sam

Checked by : Mike

Approved by : Herbert

TITLE : 40.0 x 7.0 x 3.0 (mm) LTE Full-Band Chip
Antenna (CC40D7J) Engineering Specification

DOCUMENT
NO.

H2UE6Q1K2G0100

REV.
F

7-2. 824~960MHz Band

3D Radiation Gain Pattern @ 890 MHz (Unit: dBi)

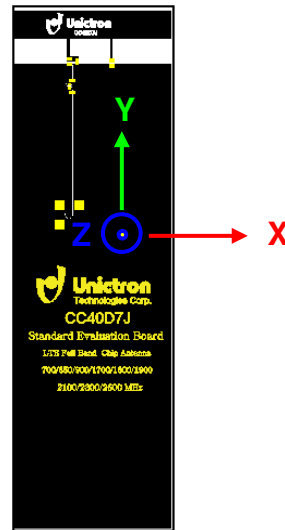
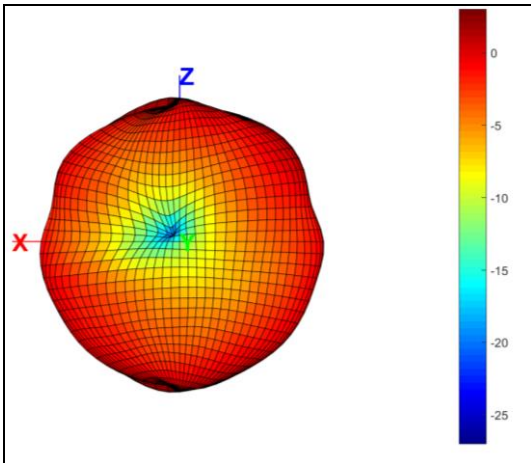
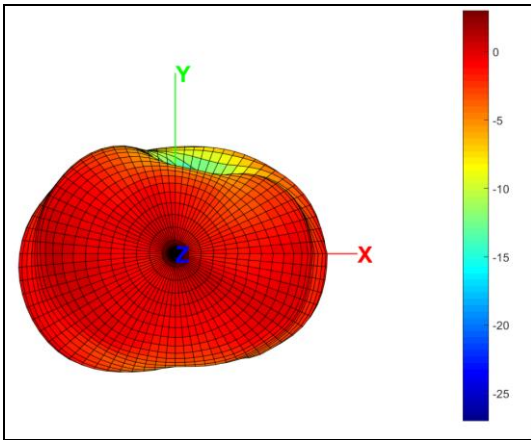
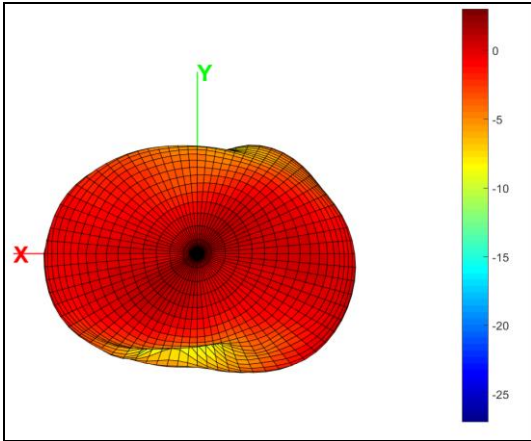

詠業科技股份有限公司
Unictron Technologies Corporation
Website: www.unictron.com

THIS DRAWINGS AND SPECIFICATIONS ARE THE PROPERTY OF UNICTRON TECHNOLOGIES CORPORATION AND SHALL NOT BE REPRODUCED OR USED AS THE BASIS FOR THE MANUFACTURE OR SALE OF APPARATUS OR DEVICES WITHOUT PERMISSION

Prepared by : Betty

Designed by : Sam

Checked by : Mike

Approved by : Herbert

TITLE : 40.0 x 7.0 x 3.0 (mm) LTE Full-Band Chip Antenna (CC40D7J) Engineering Specification

DOCUMENT NO.

H2UE6Q1K2G0100

REV.
F

7-3. 1710~2170MHz Band

3D Radiation Gain Pattern @ 1950 MHz (Unit: dBi)

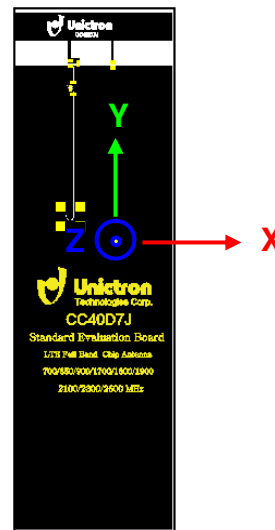
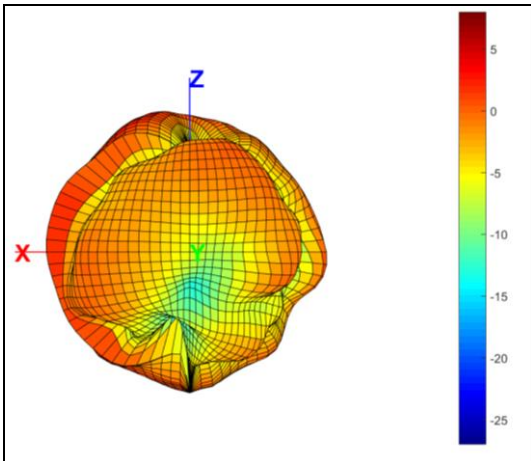
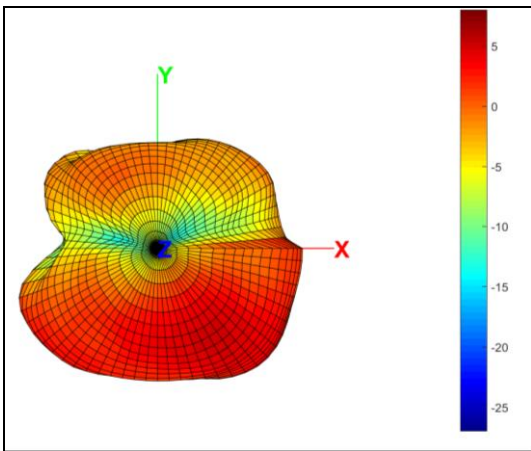
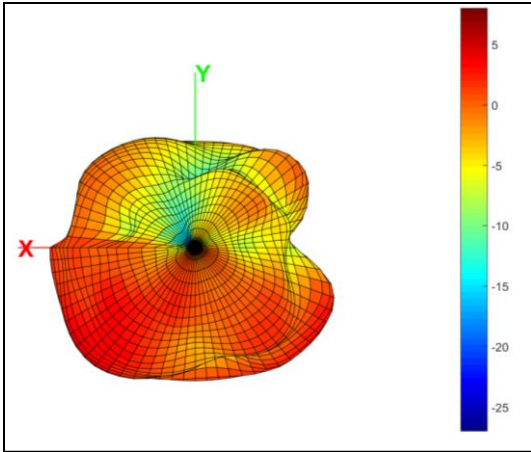

詠業科技股份有限公司
Uniconn Technologies Corporation
Website:www.uniconn.com

THIS DRAWINGS AND SPECIFICATIONS ARE THE PROPERTY OF UNICTRON TECHNOLOGIES CORPORATION AND SHALL NOT BE REPRODUCED OR USED AS THE BASIS FOR THE MANUFACTURE OR SALE OF APPARATUS OR DEVICES WITHOUT PERMISSION

Prepared by : Betty

Designed by : Sam

Checked by : Mike

Approved by : Herbert

TITLE : 40.0 x 7.0 x 3.0 (mm) LTE Full-Band Chip
Antenna (CC40D7J) Engineering Specification

DOCUMENT NO.

H2UE6Q1K2G0100

REV.
F

7-4. 2300~2400MHz Band

3D Radiation Gain Pattern @ 2350 MHz (Unit: dBi)

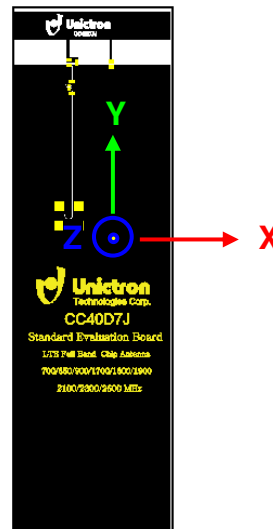
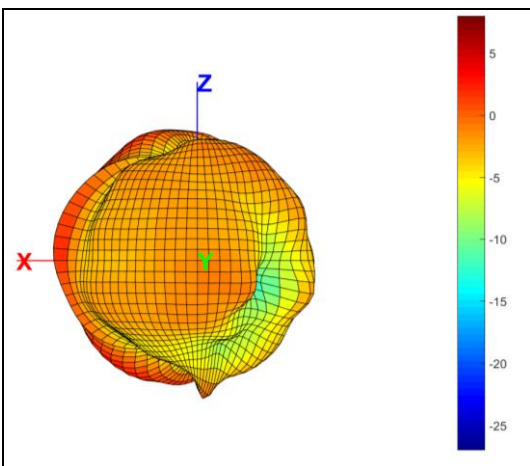
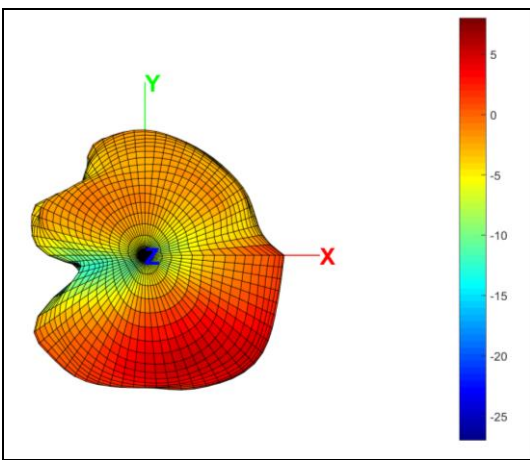
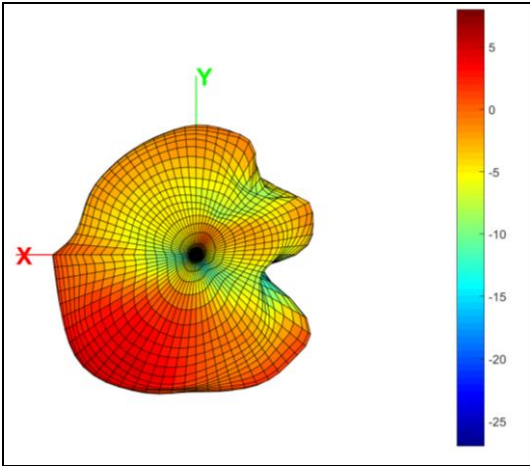

詠業科技股份有限公司
Unictron Technologies Corporation
Website: www.unictron.com

THIS DRAWINGS AND SPECIFICATIONS ARE THE PROPERTY OF UNICTRON TECHNOLOGIES CORPORATION AND SHALL NOT BE REPRODUCED OR USED AS THE BASIS FOR THE MANUFACTURE OR SALE OF APPARATUS OR DEVICES WITHOUT PERMISSION

Prepared by : Betty

Designed by : Sam

Checked by : Mike

Approved by : Herbert

TITLE : 40.0 x 7.0 x 3.0 (mm) LTE Full-Band Chip
Antenna (CC40D7J) Engineering Specification

DOCUMENT NO.

H2UE6Q1K2G0100

REV.
F

7-5. 2490~2690MHz Band

3D Radiation Gain Pattern @ 2590 MHz (Unit: dBi)

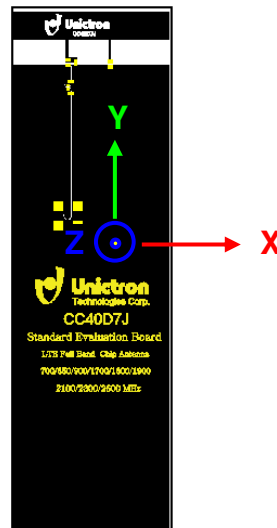
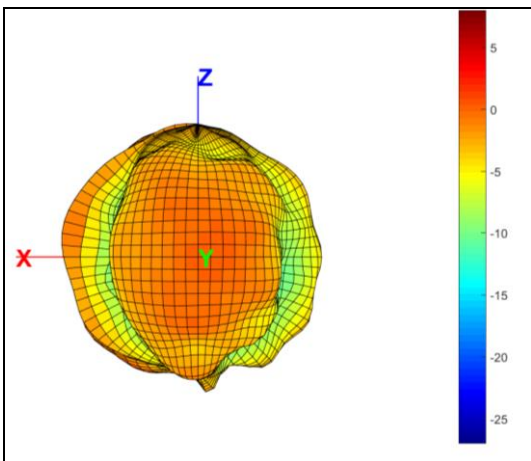
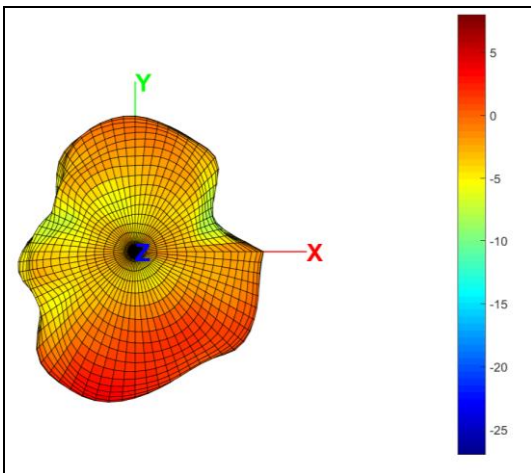
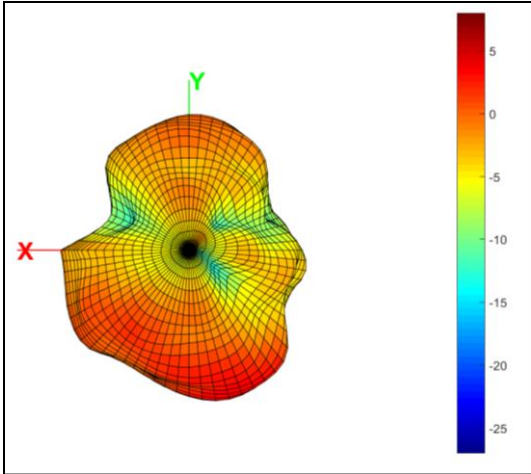

詠業科技股份有限公司
 Unictron Technologies Corporation
 Website:www.unictron.com

THIS DRAWINGS AND SPECIFICATIONS ARE THE PROPERTY OF UNICTRON TECHNOLOGIES CORPORATION AND SHALL NOT BE REPRODUCED OR USED AS THE BASIS FOR THE MANUFACTURE OR SALE OF APPARATUS OR DEVICES WITHOUT PERMISSION

Prepared by : Betty

Designed by : Sam

Checked by : Mike

Approved by : Herbert

TITLE : 40.0 x 7.0 x 3.0 (mm) LTE Full-Band Chip Antenna (CC40D7J) Engineering Specification

DOCUMENT NO.

H2UE6Q1K2G0100

REV. F

8. Frequency tuning and Matching circuit

8-1. Chip antenna tuning scenario :

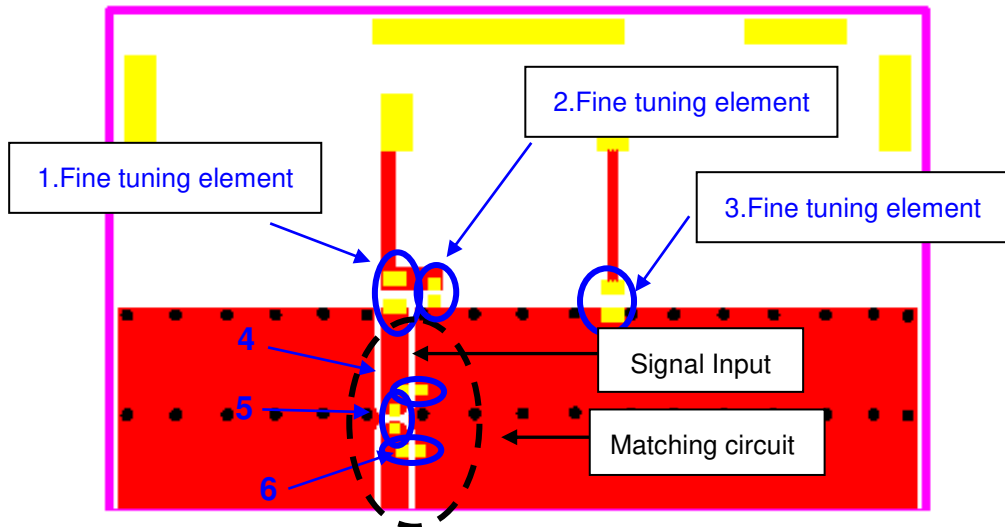

8-2. Matching circuit :

With the following recommended values of matching and tuning components, the covering frequencies will be about 698~960 MHz & 1710~2690 MHz at our standard 135 x 41 mm² evaluation board. However, these are typical reference values which may need to be changed when circuit boards or part vendors are different.

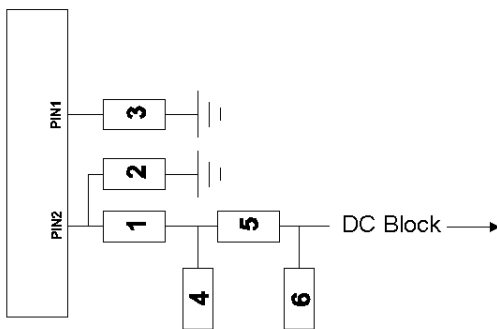

System Matching Circuit Component			
Location	Description	Vendor	Tolerance
1 Fine tuning element	3.9 nH, (0402)	MURATA	±0.1 nH
2 Fine tuning element	0.7 pF, (0402)	MURATA	±0.05 pF
3 Fine tuning element	3.9 nH, (0402)	MURATA	±0.1 nH
4	N/C	-	-
5	0Ω, (0402)	-	-
6	N/C		



詠業科技股份有限公司
Unictron Technologies Corporation
Website: www.unictron.com

THIS DRAWINGS AND SPECIFICATIONS ARE THE PROPERTY OF UNICTRON TECHNOLOGIES CORPORATION AND SHALL NOT BE REPRODUCED OR USED AS THE BASIS FOR THE MANUFACTURE OR SALE OF APPARATUS OR DEVICES WITHOUT PERMISSION

Prepared by : Betty

Designed by : Sam

Checked by : Mike

Approved by : Herbert

TITLE : 40.0 x 7.0 x 3.0 (mm) LTE Full-Band Chip
Antenna (CC40D7J) Engineering Specification

DOCUMENT
NO.

H2UE6Q1K2G0100

REV.
F

9. Soldering Conditions

Typical Soldering Profile for Lead-free Process

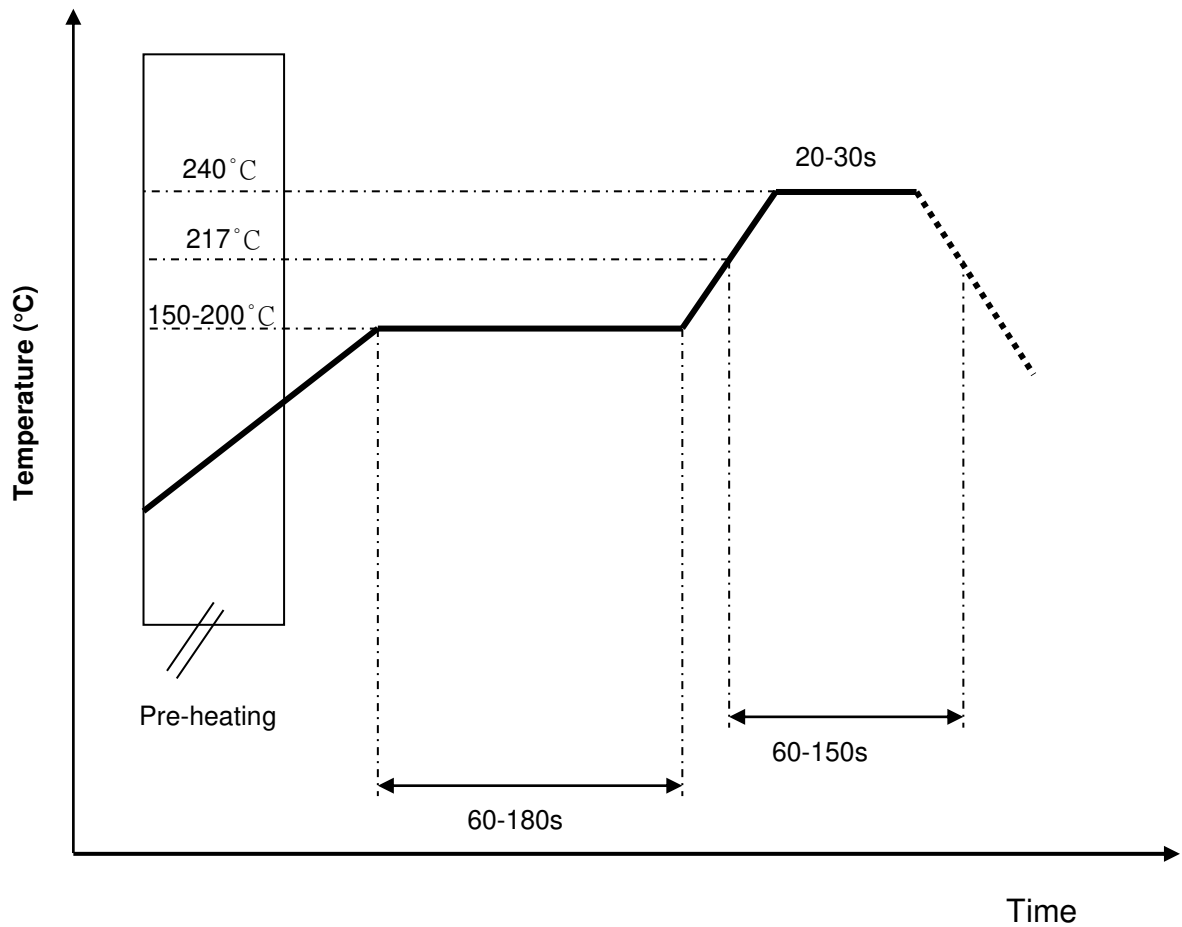

*Recommended solder paste alloy: SAC305 (Sn96.5 /Ag3 /Cu0.5) Lead Free solder paste



詠業科技股份有限公司
Unictron Technologies Corporation
Website: www.unictron.com

THIS DRAWINGS AND SPECIFICATIONS ARE THE PROPERTY OF UNICTRON TECHNOLOGIES CORPORATION AND SHALL NOT BE REPRODUCED OR USED AS THE BASIS FOR THE MANUFACTURE OR SALE OF APPARATUS OR DEVICES WITHOUT PERMISSION

Prepared by : Betty

Designed by : Sam

Checked by : Mike

Approved by : Herbert

TITLE : 40.0 x 7.0 x 3.0 (mm) LTE Full-Band Chip
Antenna (CC40D7J) Engineering Specification

DOCUMENT
NO.

H2UE6Q1K2G0100

REV.
F

10. Packing

- (1) Quantity/Reel: 1000 pcs/Reel
- (2) Plastic tape: Black Conductive Polystyrene.

a. Tape Drawing

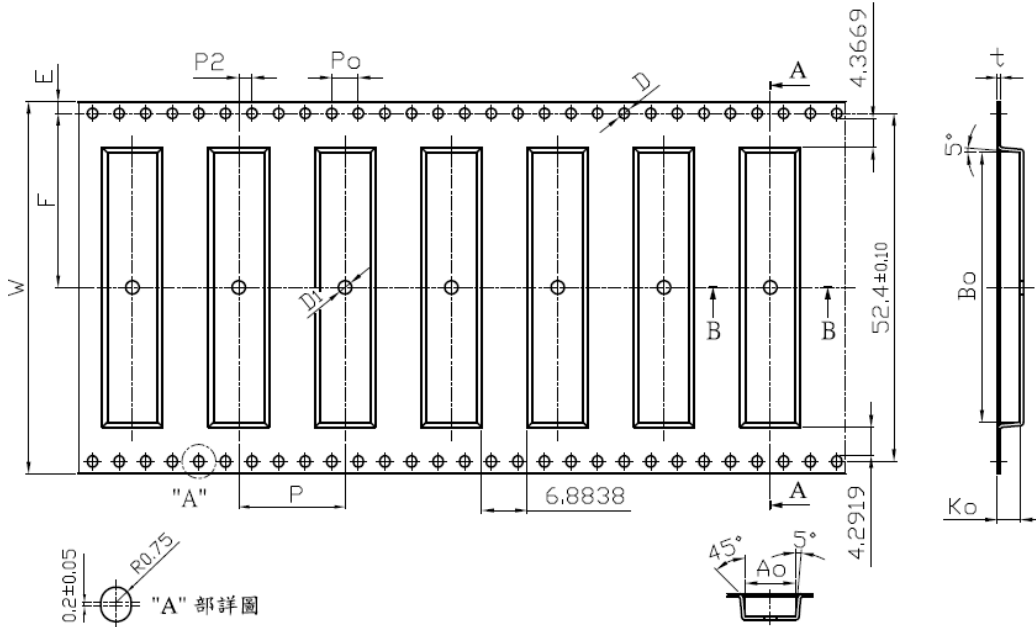

b. Tape Dimensions (unit: mm)

外觀	規格	公差	外觀	規格	公差
W	56.00	±0.30	Ao	7.60	±0.10
P	16.00	±0.10	Bo	40.60	±0.10
E	1.75	±0.10	Ko	3.45	±0.10
F	26.20	±0.15	t	0.50	±0.05
P2	2.00	±0.15			
D	1.50	+0.10 -0.00			
D1	2.00	±0.10			
Po	4.00	±0.10			
10Po	40.00	±0.20			



詠業科技股份有限公司
Unictron Technologies Corporation
Website: www.unictron.com

THIS DRAWINGS AND SPECIFICATIONS ARE THE PROPERTY OF UNICTRON TECHNOLOGIES CORPORATION AND SHALL NOT BE REPRODUCED OR USED AS THE BASIS FOR THE MANUFACTURE OR SALE OF APPARATUS OR DEVICES WITHOUT PERMISSION

Prepared by : Betty

Designed by : Sam

Checked by : Mike

Approved by : Herbert

TITLE : 40.0 x 7.0 x 3.0 (mm) LTE Full-Band Chip
Antenna (CC40D7J) Engineering Specification

DOCUMENT
NO.

H2UE6Q1K2G0100

REV.
F

11. Operating & Storage Conditions

11-1. Operating

- (1) Maximum Input Power: 2 W
- (2) Operating Temperature: -40°C to 85°C
- (3) Relative Humidity: 10% to 70%

11-2. Storage (sealed)

- (1) Storage Temperature: -5°C to 40°C
- (2) Relative Humidity: 20% to 70%
- (3) Shelf Life: 1 year

11-3. Storage (After mounted on customer's PCB with SMT process)

- (1) Storage Temperature: -40°C to 85°C
- (2) Relative Humidity: 10% to 70%

12. Notice

(1) Installation Guide:

Please refer to Unictron's application note "General guidelines for the installation of Unictron's chip antennas" for further information.

(2) All specifications are subject to change without notice



詠業科技股份有限公司
Unictron Technologies Corporation
Website: www.unictron.com

THIS DRAWINGS AND SPECIFICATIONS ARE THE PROPERTY OF UNICTRON TECHNOLOGIES CORPORATION AND SHALL NOT BE REPRODUCED OR USED AS THE BASIS FOR THE MANUFACTURE OR SALE OF APPARATUS OR DEVICES WITHOUT PERMISSION

Prepared by : **Betty**

Designed by : **Sam**

Checked by : **Mike**

Approved by : **Herbert**

**TITLE : 40.0 x 7.0 x 3.0 (mm) LTE Full-Band Chip
Antenna (CC40D7J) Engineering Specification**

**DOCUMENT
NO.**

H2UE6Q1K2G0100

**REV.
F**