

Steward

Advanced Ferrite Materials, EMI Suppression, and Inductive Products

Home • Ferrite Product Lines • New Products • Technical • General • Contact • Steward Sales

CM3440Z171B-00

| STEWARD PART NUMBERING SYSTEM | | | | | |
|-------------------------------|----------------|--------------------|----------------------|----------------|------------------------|
| PRODUCT SERIES CODE | PART SIZE CODE | RATED CURRENT CODE | IMPEDANCE VALUE CODE | PACKAGING CODE | ADDITIONAL DESCRIPTION |
| CM | 2545 | X | 111 | B | - 00 |

Ambient Operating Temperature Range: -55°C to +125°C

Surface Mount

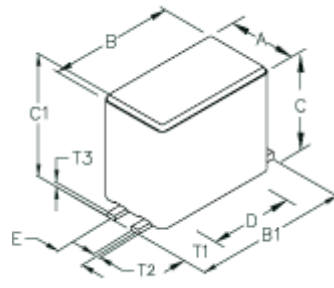

Figure #1

Thru-Hole

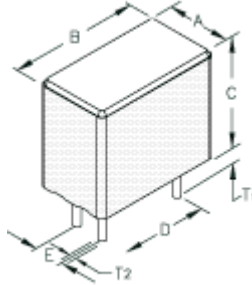

Figure #2

Surface Mount

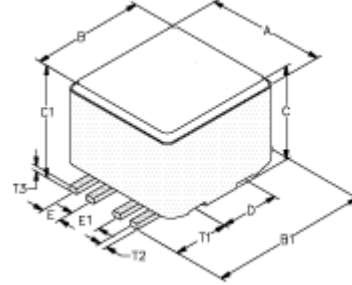

Figure #3

Surface Mount

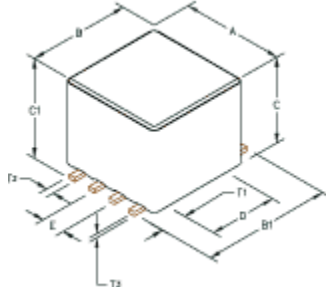

Figure #4

Thru-Hole

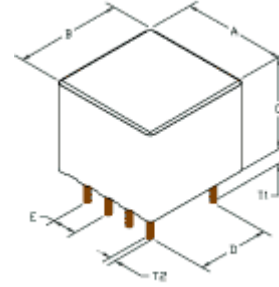
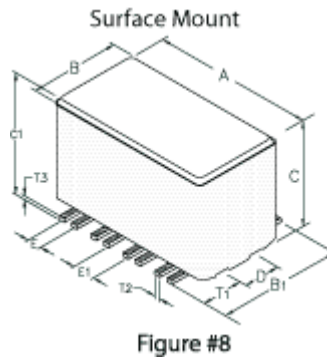
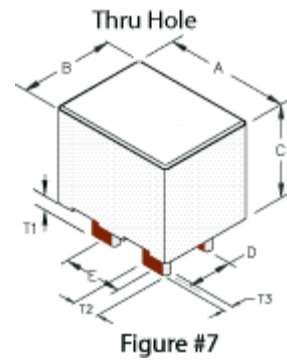
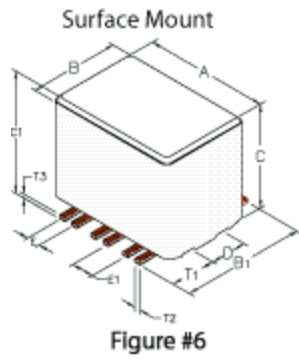

Figure #5



Drawing Figure #

| |
|------------------|
| Figure Number |
| 2 |

Electrical Characteristics

| | | |
|--------------------|------------|------------------------|
| NET Z @ 100 MHz | DCR Max | Rated Current mA |
| 170 | 0.001 | 20000 |

Physical Dimensions

| A | B | B1 | C | C1 | D | E | E1 | A | B | B1 | C | C1 | D | E | E1 |
|------|-------|----|------|-------|------|------|----|-------|-------|----|-------|-------|-------|-------|----|
| mm | mm | mm | mm | mm | mm | mm | mm | in | in | in | in | in | in | in | in |
| 8.51 | 10.03 | - | 9.32 | 12.90 | 4.06 | 2.54 | - | 0.335 | 0.395 | - | 0.367 | 0.508 | 0.160 | 0.100 | - |

Wire Dimensions

| T1 mm | T2 mm | T3 mm | T1 in | T2 in | T3 in |
|-------|-------|-------|-------|-------|-------|
| 3.12 | 0.76 | 0.76 | 0.123 | 0.030 | 0.030 |

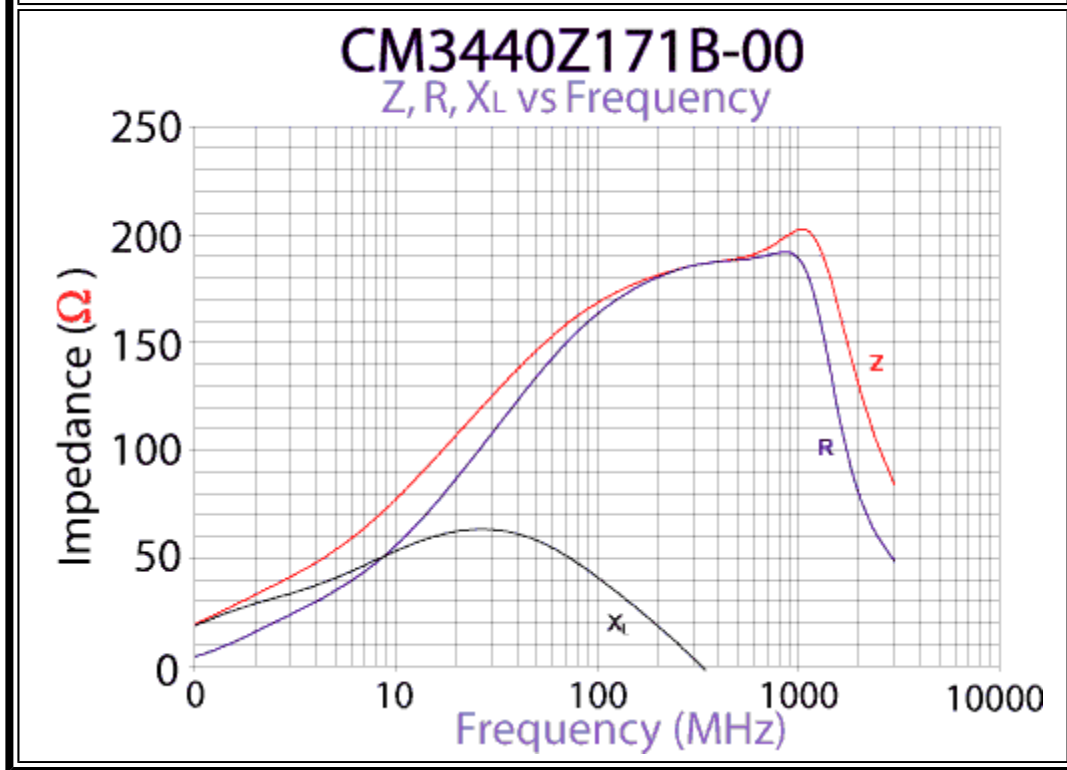
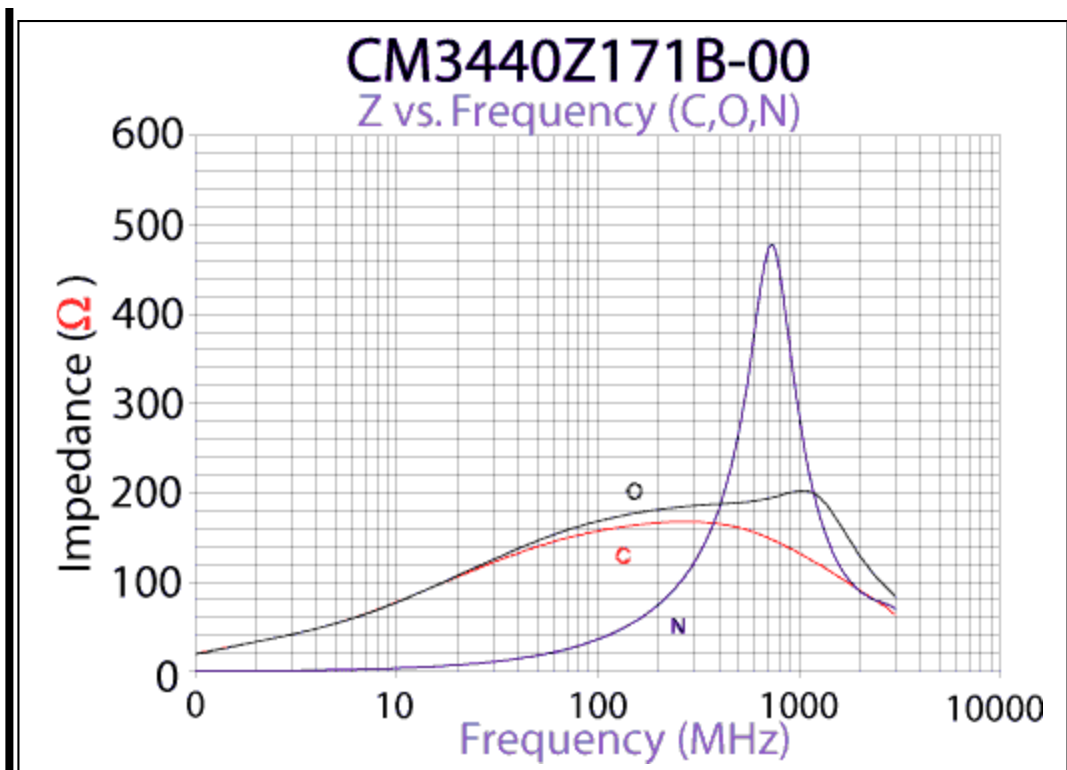

Specifications, which provide more details for the correct use of the described products, are available upon request. All specifications are subject to change without notice. For more information on any of the products listed above, please contact Steward customer service department at (800) 634-2673.

americas@steward.commexico@steward.comeuropa@steward.comasia@steward.com

Copyright© 2004 Steward, Inc.

Last Updated: 2/24/2004