

# C030-R412M

LTE Cat M1/NB1 and 2G Mbed Enabled™ IoT starter kit  
User Guide



## Abstract

This guide explains how to set up the C030 Arm® Mbed Enabled™ Internet of Things Starter Kit to begin evaluating u-blox LTE Cat M1 / NB1 cellular and GNSS modules.

# Document Information

<b>Title</b>	<b>C030-R412M</b>	
<b>Subtitle</b>	LTE Cat M1/NB1 and 2G Mbed Enabled™ IoT starter kit	
<b>Document type</b>	User Guide	
<b>Document number</b>	UBX-19010121	
<b>Revision and date</b>	R01	01-Jul-2019
<b>Disclosure Restriction</b>		

<b>Product status</b>	<b>Corresponding content status</b>	
<b>Functional Sample</b>	Draft	For functional testing. Revised and supplementary data will be published later.
<b>In Development / Prototype</b>	Objective Specification	Target values. Revised and supplementary data will be published later.
<b>Engineering Sample</b>	Advance Information	Data based on early testing. Revised and supplementary data will be published later.
<b>Initial Production</b>	Early Production Information	Data from product verification. Revised and supplementary data may be published later.
<b>Mass Production / End of Life</b>	Production Information	Document contains the final product specification.

This document applies to the following products:

<b>Product name</b>	<b>Type number</b>	<b>Firmware version</b>	<b>PCN reference</b>	<b>Product status</b>
C030	C030-R412M-0-00	G0.V.00.00.10R	UBX-19027009	Initial production

u-blox or third parties may hold intellectual property rights in the products, names, logos and designs included in this document. Copying, reproduction, modification or disclosure to third parties of this document or any part thereof is only permitted with the express written permission of u-blox.

The information contained herein is provided "as is" and u-blox assumes no liability for its use. No warranty, either express or implied, is given, including but not limited to, with respect to the accuracy, correctness, reliability and fitness for a particular purpose of the information. This document may be revised by u-blox at any time without notice. For the most recent documents, visit [www.u-blox.com](http://www.u-blox.com).

Arduino® is a trademark of Arduino Srl or Arduino LLC registered and/or used in the EU, the U.S. and other countries/regions. Arm and Mbed™ are registered trademarks of Arm Limited (or its subsidiaries) in the US and/or elsewhere.

JT® is a registered trademark of JTGlobal Limited in the EU, the U.S. and other countries/regions  
Copyright © u-blox AG.

# Contents

<b>Document Information</b> .....	<b>2</b>
<b>Contents</b> .....	<b>3</b>
<b>1 Overview</b> .....	<b>4</b>
Using this guide.....	4
Warnings and certifications.....	5
<b>2 Hardware description</b> .....	<b>6</b>
2.1 C030-R412M block diagram.....	8
2.2 Buttons, jumpers and switches .....	10
2.2.1 Utilization of cellular modem USB sniffer.....	11
2.3 LED indicators .....	12
2.4 Connectors .....	13
2.5 Configuration links / components .....	14
2.6 Test, break out points, and debug interfaces .....	18
2.7 Arduino™ UNO R3 compatible interface pin out.....	19
2.8 Power supply options and LiPo battery usage.....	20
<b>3 Getting started</b> .....	<b>22</b>
3.1 C030-R412M board setup .....	22
3.2 Development PC USB driver configuration.....	22
3.3 Getting started with Mbed.....	22
<b>4 Approvals</b> .....	<b>23</b>
4.1 European Conformance .....	23
4.2 US Federal Communications Commission notice.....	24
4.3 Innovation, Science, Economic Development Canada notice .....	24
<b>Appendix</b> .....	<b>25</b>
<b>A Glossary</b> .....	<b>25</b>
<b>Related documents</b> .....	<b>26</b>
<b>Revision history</b> .....	<b>26</b>
<b>Contact</b> .....	<b>27</b>

# 1 Overview

The u-blox LTE Cat M1/NB1 and 2G Mbed Enabled™ IoT starter kit is a versatile development platform that allows quick prototyping of a variety of applications for low-power Internet of Things (IoT).

The u-blox C030-R412M belongs to the u-blox C030 application board family, which consists of several variants based on the type of u-blox cellular module used:

- SARA-U201 HSPA module with 2G fallback
- SARA-N211 NB-IoT (LTE Cat NB1) module
- SARA-R412M LTE Cat M1 / NB1 and 2G module
- LARA-R3121 LTE Cat 1 single-mode module with integrated GNSS receiver

The u-blox C030 application boards, except C030-R3121, have a u-blox MAX-M8C module or a ZOE GNSS SiP as a concurrent GNSS receiver, thereby enabling straight forward development of location-aware, globally communicating applications.

The u-blox C030-R412M board provides access to a variety of hardware interfaces (10/100 Mb/s Ethernet, 22 GPIOs with SPI, I<sup>2</sup>C, UART, PWM) through the Arduino™ Uno R3 compatible header connector.

An eUICC (embedded SIM) is integrated on the u-blox C030-R412M-U201 / C030-R3121 variants. The eUICC comes with International Data Roaming Cellular Connectivity Service by JT<sup>®</sup> JTGlobal (formerly Jersey Telecom) with 50 MB of data for the period of 90 days, which can be topped up and extended on demand.

The u-blox C030-R412M board is powered by an Arm<sup>®</sup> Cortex-M4 based ST<sup>®</sup> STM32F437VGT Host microcontroller, which is fully supported by the Arm<sup>®</sup> Mbed™ platform. The microcontroller has 512 kB flash, 64 kB RAM, and runs an up-to-96 MHz system clock. The board provides simple USB drag-n-drop programming and an ST-Link debug interface for the Host microcontroller. The Arm Mbed platform provides free software libraries and online tools for professional rapid prototyping. The programming is done using a standard-based C/C++ SDK. The Arm Mbed compiler also supports full export to various tool chains, for projects that demand it as they go into production.

The u-blox C030-R412M also works with a wide choice of Integrated Development Environments (IDEs) including but not limited to Arm<sup>®</sup> Keil<sup>®</sup>, GCC-based Eclipse IDEs.

This document applies to the C030-R412M variant integrating the SARA-R412M LTE Cat M1/NB1 and 2G module, and the ZOE-M8B GNSS receiver SiP (System-in-Package) only.

## Using this guide

This guide assumes the user has basic computer skills and is familiar with the Windows Graphical User Interface (GUI) and cellular module environments.

The following symbols are used to highlight important information in the document:



An index finger points out key information pertaining to device operation and performance.



A warning symbol indicates actions that could negatively impact or damage the device.

## Warnings and certifications



C030-R412M is an Electrostatic Sensitive Device (ESD).



**CAUTION! Risk of short circuit of the battery when touching it with conducting parts. In the unlikely event of a failure in the internal protection circuitry, there is a risk of an explosion when charging fully or partially discharged batteries. Replace the battery if it no longer has sufficient charge for unit operation. Control the battery before using it if the device has not been operated for an extended period of time.**

C030-R412M application boards comply with the Directive 2011/65/EU of the European Parliament and the Council on the Restriction of Use of certain Hazardous Substances in Electrical and Electronic Equipment (EU RoHS 2) and its amendment Directive (EU) 2015/863 (EU RoHS 3).

C030-R412M application boards are RoHS 3 compliant and green (no halogens).

See section [4](#) for further details about certification approvals.

## 2 Hardware description

The u-blox C030-R412M has the following onboard hardware features:

- u-blox SARA-R412M LTE Cat M1/NB1 and 2G module
- u-blox ZOE-M8B concurrent GNSS receiver SiP for up to 3 GNSS (GPS, Galileo, GLONASS, and BeiDou)
- STM32F437VG Cortex-M4 ARM Host MCU with 1024 kB Flash, 256 kB SRAM and SWD connector
  - 12 MHz crystal oscillator for system clock
  - 32.768 kHz crystal oscillator for real-time clock
  - 1.8 V operation
- On-board ST-Link/V2-1 debugger/programmer with SWD connector
  - ST-Link/V2-1 standalone development and debug capability
  - USB re-enumeration; Virtual COM port, Mass Storage Device and Debug Port
  - 5V from ST-Link/V2-1 Debug USB VBUS, 3.3V operation
  - (CMSIS-DAP variant of the FW with extended features will be available in the future)
- On-board TI® bq24295 Single Cell LiPo battery charger and TI® bq27441-G1 Battery Fuel Gauge
- Molex® SPOX™ 5268-03A LiPo battery connector
  - Supports battery types like LP-503759-IS-3 from BAK (battery is not included)
- On-board SiLabs® CP2105 USB to Dual UART Bridge as Serial USB sniffer
  - Alternative to ST-Link/V2-1 Virtual COM Port when ST-LINK/V2-1 is not used/available
  - Alternative to Main Supply and Debug USB 5V VBUS inputs
  - Sniffing serial communication between the Host MCU and the Cellular module
- RGB User LED, and two push buttons: User and Reset
- On-board SiLabs® Si7034-A10 Humidity and Temperature Sensor
  - Only the temperature sensor is used; it cannot be used for humidity measurements
- SD card socket for file storage
- SMA RF connectors for 50 Ω cellular and GNSS active antennas
- MicroSIM card holder
- Extension:
  - Arduino™ Uno R3 compatible interface
  - 6 analog capable inputs
  - 8 PWM capable outputs
  - 22 GPIOs
  - 1 x SPI
  - 1 x I2C
  - 1 x UART with HW flow control option (RTS, CTS)
- Flexible board power supply:
  - 5 V main supply USB, debug USB, and sniffer USB VBUS inputs
  - Arduino UNO R3 VIN input for external power supply

 VIN voltage level should not exceed the C030 component and SARA-R412M absolute maximum ratings.

- 2.8 V to 4.4 V LiPo Battery input
- Support of a wide range of Integrated Development Environments (IDEs), including but not limited to GCC-based IDEs, ARM mbed
- ARM mbed Enabled (see <http://mbed.org>)

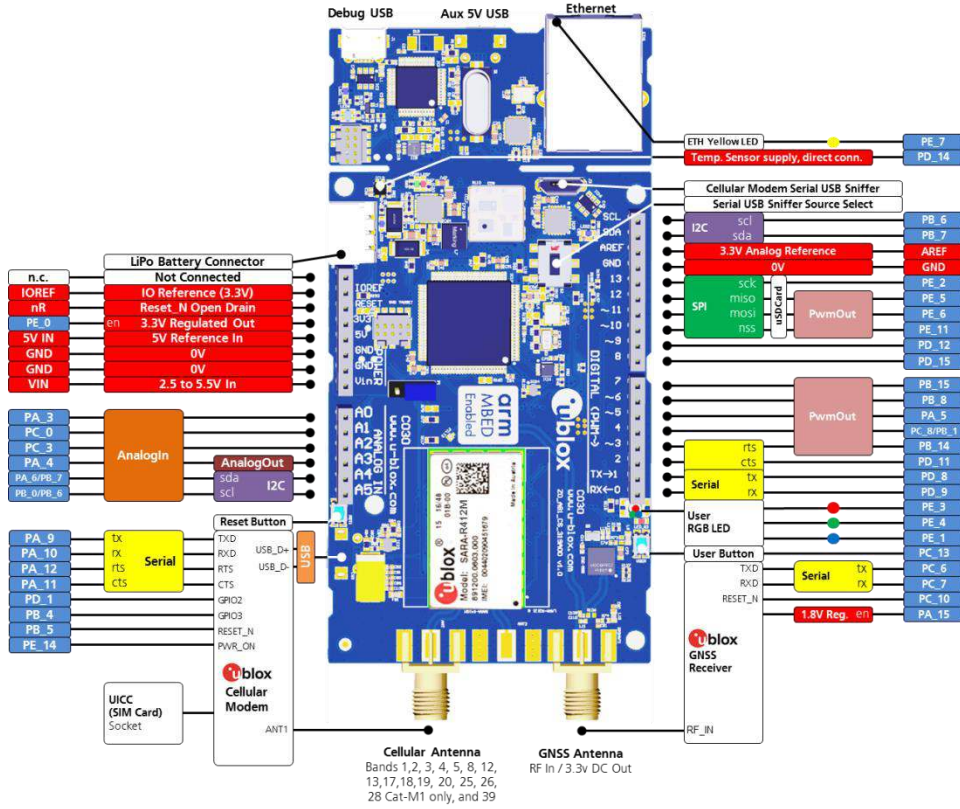

Figure 1: C030-R412M application board overview

## 2.1 C030-R412M block diagram

Figure 2 shows the block diagram of the C030-R412M.

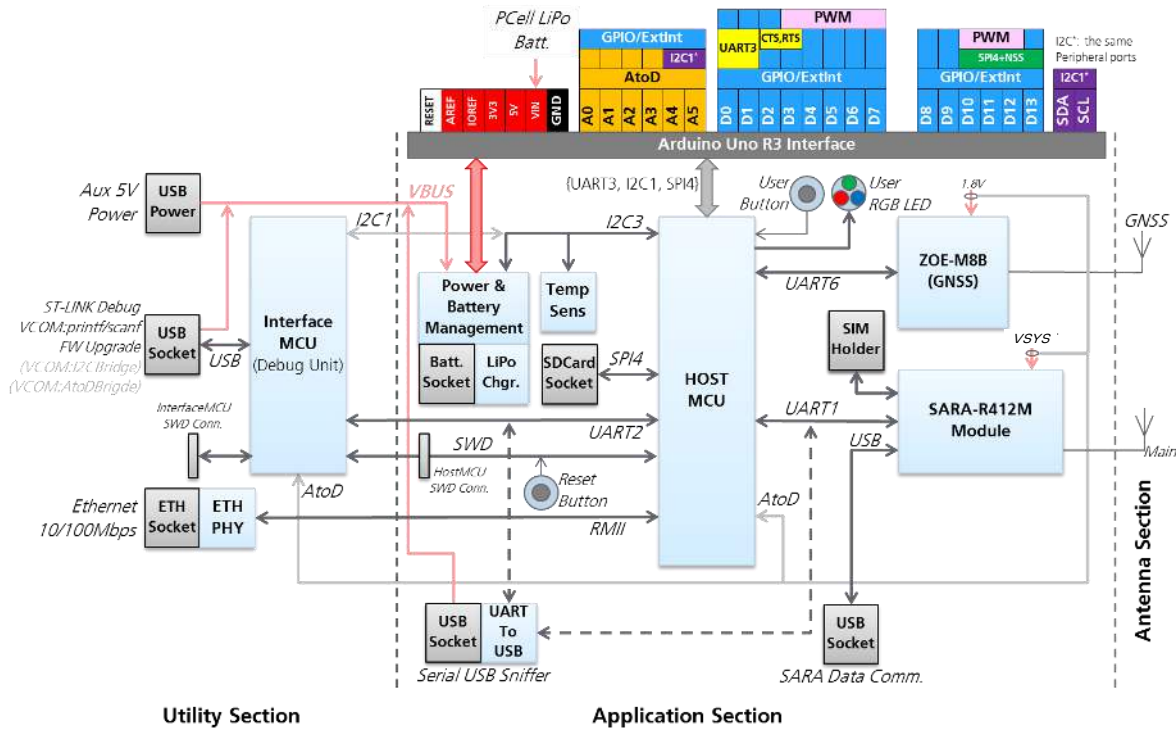

Figure 2: C030-R412M block diagram

Figure 2 shows the major interfaces and internal connections of the C030-R412M.

The major component layout of the board is provided in Figure 3.

The C030-R412M consists of three sections:

### Utility section

The utility section accommodates the components that provide SW debugging / virtual COM port (ST-Link/CMSIS-DAP) and Ethernet Interface functions. The SW debugging / virtual COM port functions are executed by the InterfaceMCU via the “Debug USB” interface.

As this section is only needed during the application development and test activities, it could be physically snapped off from the application section to decrease the size and power consumption.

The utility section is powered up from the “Debug USB” 5V VBus. When the “Debug USB” is not connected, SW debugging / virtual COM port and Ethernet Interface functions are turned off and isolated from the application section.

The “Auxiliary 5V USB” connector on the utility section could be used to boost the power input to the application section if the current input from the “Debug USB” 5V Vbus is not sufficient.

### Application section

The application section accommodates the GNSS and cellular modules, a eUICC (Embedded SIM) / MicroSIM socket, the HostMCU, the battery charging/management and power supply circuitry, the SD card interface and socket, the Serial USB sniffer for communication between the HostMCU to the cellular module and similarly to the InterfaceMCU. The application section also has a temperature sensor for measuring ambient temperature of the board. Reset and user buttons, configuration jumpers and User and system status indication LEDs are placed in the application section.



The application section is designed for minimal power consumption. Unutilized circuitries and sections could be either turned off by software or inhibited electronically.

The Arduino Uno R3 interface on the application section could be used to integrate sensors, actuators and power/battery supply circuitries as Arduino Shields/expansion daughter PCBs.

The application section could run standalone when the utility section is snapped off.

### Antenna section

The C030-R412M has SMA Jack edge connectors for Cellular and GNSS antennas.

The C030-R412M major component layout is provided in [Figure 3](#).

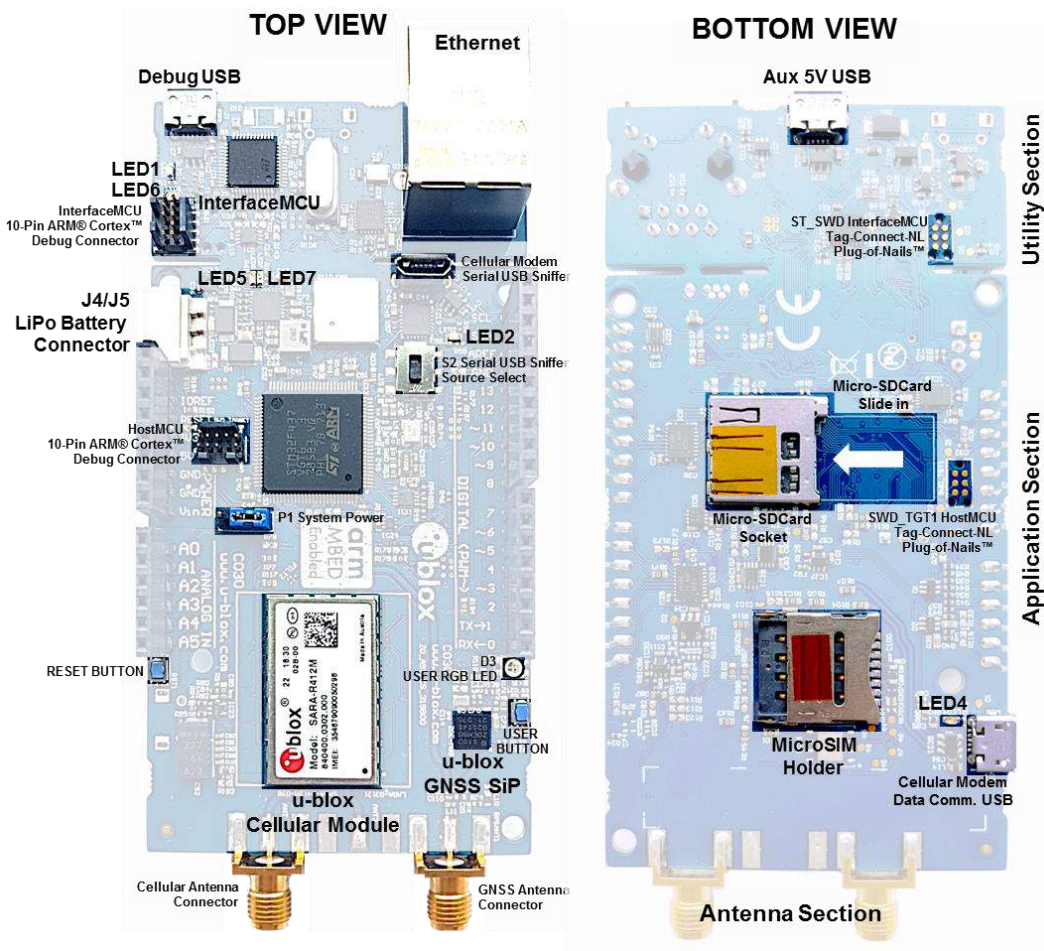

Figure 3: C030-R412M major component locations

## 2.2 Buttons, jumpers and switches

The C030-R412M is equipped with several buttons, jumpers and a switch that the user can easily utilize. The functions and locations of these components are provided in [Table 1](#) and shown in [Figure 3](#).

Annotation	Function	Description	Section
USER	User button	Push button for application use. Connected to HostMCU GPIO Port PC13	Application
RST1	Reset button	Push button to reset the HostMCU	Application
P1	System power jumper	System power input selection: <ul style="list-style-type: none"> <li>Pin 1-2: on board Power/Battery Management (<b>default configuration</b>)</li> <li>Pin 2-3: VIN pin of Arduino Uno R3 interface</li> </ul>	Application
S2	Serial USB sniffer source select	Select the cellular module communication UART channel to sniff: <ul style="list-style-type: none"> <li>Position 1: isolation</li> <li>Position 2: UART1 communication between HostMCU and cellular module</li> </ul>	Application

**Table 1: C030-R412M buttons, jumpers, and switches**

[Figure 4](#) shows the C030-R412M P1 and P3 jumpers and S2 switch positions.

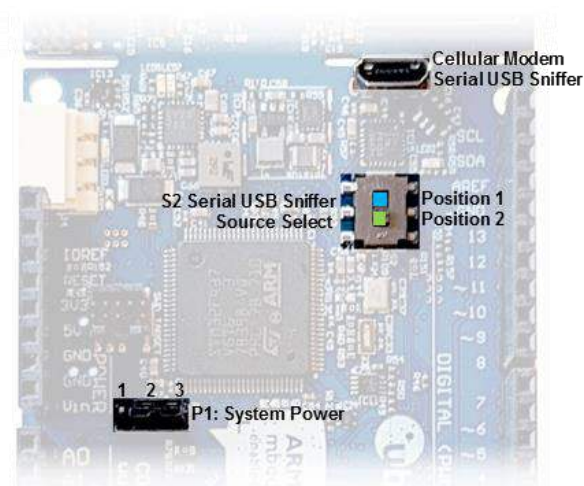

**Figure 4: C030-R412M jumper and switches**

## 2.2.1 Utilization of cellular modem USB sniffer

The C030-R412M cellular modem USB sniffer provides two virtual UART COM channels to the connected USB master (development PC). The cellular modem USB sniffer USB VBUS 5VDC rail power the application section of the C030-R412M. The virtual COM ports are utilized as follows;

- Standard COM port as on the development PC: HostMCU USART2 Tx “printf” Channel sniffing
  - HostMCU USART2 Tx is also connected to the InterfaceMCU on the utility section
  - HostMCU USART2 Rx is connected to InterfaceMCU on the utility section
  - Host HostMCU USART2 Rx can be connected to cellular modem USB sniffer Standard COM port Tx channel via R137 link (see [Table 4](#)). In this case, do **one** of the following:
    - The utility section should be powered off (disconnect Debug USB)
    - Snap off the utility section
    - Remove R133 link (see [Table 4](#))
- Enhanced COM port as on the development PC. Two operation modes can be selected by using S2 switch (see [Figure 4](#)):
  - **S2 position 1:** Isolation
  - **S2 position 2:** HostMCU USART1 to cellular module communication. Allows direct access to the cellular module. In this case, do **one** the following:
    - Remove R105 link
    - Set the HostMCU PA\_5 Port as GPIO input to avoid collusion











 Enhanced COM port Mode 1 direct access to the cellular module allows using development PC applications like u-blox m-center, to exercise cellular module AT command interface bypassing the C030-R412M HostMCU.

## 2.3 LED indicators

The C030-R412M has a few LEDs to indicate the board status for generic application use. Due to the low power design of C030-R412M, if the C030-R412M is **not** connected to an external power source or is powered from battery only, all the LEDs except D3 (User RGB LED) are turned off.

As the D3 and LED\_G3 LEDs are controlled by the application, they can be completely turned off to save power.

The C030-R412M LED indicators are listed in [Table 2](#) and their locations are depicted in [Figure 3](#).

Annotation	Function	Description	Color
LED1	Debug USB VBUS	VBUS 5 V indicator for InterfaceMCU supply	
LED2	Serial USB Sniffer VBUS	VBUS 5 V indicator for serial USB sniffer supply	
LED3	Aux 5 V USB VBUS	VBUS 5 V indicator for 5 VDC supply input	
LED4	Cellular module USB VBUS	VBUS 5 V indicator	
LED5	Battery charging / man. Input	Battery Charging/Management 5 VDC input supply indicator	
LED6	STLink/CMSIS-DAP status	InterfaceMCU Debugging/Flashing status RED/GREEN indicator	
LED7	Battery charging status	Battery Charging/Management battery charging status indicator	
D3	User RGB LED	HostMCU GPIO driven; PE_3: RED, PE_4: GREEN, PE_1: BLUE (all negative logic)	
ETH green <sup>1</sup>	ETH connection speed	Connection speed indication. On:100 Mb/s, Off:10 Mb/s	
ETH yellow <sup>1</sup>	ETH transaction/traffic	Indicates Ethernet transaction. Controlled by HostMCU GPIO PE_7	

**Table 2: C030-R412M LED indicators**

<sup>1</sup>Ethernet LED indicators are powered by 3.3 VDC generated from the Debug USB VBUS, which powers the whole Utility section. If the Debug USB is not connected to a USB master (for example, a development PC), the Utility section is powered down, and therefore the Ethernet LED indicators do not light up.

## 2.4 Connectors

The C030-R412M has various connectors as listed in [Table 3](#). See [Figure 3](#) for connector locations.

Name	Function	Description	Section
ETH1	Ethernet receptacle	10/100 Mb/s Ethernet network connector	Utility
J6	Auxiliary 5V USB	Micro USB device connector for auxiliary 5 VDC supply input to connect a high current 5 VDC PSU	Utility
J1	Debug USB	Micro USB device connector for 5 VDC supply and ST-Link/CMSIS-DAP debug interface	Utility
J2	Micro SD card socket	Micro SD card holder for FAT file system	Application
J3	Serial USB sniffer	Micro USB device connector for 5 VDC supply and serial USB sniffer interface	Application
J4/J5	LiPo battery connector	LiPo chargeable battery connector. J4: Not populated alternative connector, J5: Molex 22-05-7035	Application
J7	Cellular module USB	Micro USB device connector for cellular module USB interface	Application
J8	SIM card holder	SIM card holder (for C030-N211 and C030-R410M only)	Application
SWD	InterfaceMCU debug	10-pin Arm Cortex debug connector for InterfaceMCU (may not be populated)	Utility
ST_SWD	InterfaceMCU debug	Tag-Connect-NL Plug-of-Nails™ connector compatible PCB touch points footprint for InterfaceMCU	Utility
SWD_TARGET	HostMCU debug	10-pin Arm Cortex debug connector for InterfaceMCU (may not be populated)	Application
SWD_TGT1	HostMCU debug	Tag-Connect-NL Plug-of-Nails connector compatible PCB touch points footprint for HostMCU	Application
ANT	Cellular main antenna	SMA connector for the cellular module primary antenna (ANT1, Tx/Rx)	Application
GPSANT	GNSS receiver antenna	SMA connector for the ZOE-M8B GNSS receiver	Application

**Table 3: C030-R412M connector description**

- 

The J2 Micro SD card socket shares the Arduino interface D10 to D13 pins, which are used as an SPI bus to the HostMCU SPI4 peripheral. The D10 pin (NSS) is used as an SD card SPI slave select signal. When the SPI bus on the Arduino interface is utilized by other SPI slaves on daughter boards, free Arduino digital IO lines should be utilized for slave select signals.
- 

As the SD card interface and its supply voltage are designed to work with 3.3 VDC, the SD card socket shall not be used when the Arduino interface IOREF voltage level is set to higher than 3.3 VDC. Such usage could cause a permanent damage and/or a failure to an SD card inserted in the J2 socket and the C030-R412M's Arduino™ interface level translators. (See R152 and R153 links in [Table 4](#)).

## 2.5 Configuration links / components

The C030-R412M has multiple configurations links and components as SMT footprints, which require de-soldering/soldering these links or components on the PCB. The footprints of these configuration links, which are listed in [Table 4](#) and depicted in [Figure 5](#), are adequate to solder 0603 SMT components or short with solder.

Name	Function	Variant <sup>2</sup> R412M	Description
R2	InterfaceMCU 1.8VDC supply sampling	●	Utilized for monitoring HostMCU 1.8 VDC supply level through a voltage divider
R3	InterfaceMCU PB_3 port pull up link	●	Link to InterfaceMCU 3.3 VDC rail
R5	InterfaceMCU 3.3VDC analog reference link	●	Reference voltage for InterfaceMCU AtoD conversion
R6	Cellular module current sense	●	(Provisional <sup>3</sup> ) Connected to cellular module power supply current instrumentation amplifier output to measure the current level
R7	GNSS module current sense	○	(Provisional <sup>3</sup> ) Connected to GNSS module power supply current instrumentation amplifier output to measure the current level
R14	InterfaceMCU 32 kHz clock input	○	Ground connection
R15	InterfaceMCU BOOT0 pull up	○	Link to InterfaceMCU 3.3 VDC PSU
R20	InterfaceMCU USART2 virtual COM Tx link	●	Link to HostMCU USART1 Tx signal through 3.3 V to 1.8 V level translator
R21	InterfaceMCU USART2 virtual COM Rx link	●	Link to HostMCU USART1 Rx signal through 3.3 V to 1.8 V level translator
R22	InterfaceMCU virtual COM loop back	○	For testing InterfaceMCU Virtual COM port
R23	InterfaceMCU I2C1 SDA link	○	(Provisional <sup>4</sup> ) Link to HostMCU I2C3 SDA bus through 3.3 V to 1.8 V level translator
R25	InterfaceMCU I2C1 SCL link	○	(Provisional <sup>4</sup> ) Link to HostMCU I2C3 SCL bus through 3.3 V to 1.8 V level translator
R31	Arduino Interface IOREF to 3.3V	●	33 Ω link to 3.3 VDC
R33	Arduino Interface 3.3V supply	●	Link to 3.3VDC rail
R38	Arduino Interface A4 pin voltage divisor	●	1 kΩ voltage divisor resistor for analog input. It could be removed for I2C SDA alternative usage
R39	Arduino Interface A5 pin voltage divisor	●	1 kΩ voltage divisor resistor for analog input. It could be removed for I2C SCL alternative usage
R47	HostMCU BOOT1 pull down	○	HostMCU BOOT1 input setting to '0'
R48	HostMCU temperature sensor power link	●	Si7034-A10 Temperature sensor power supply link <sup>5</sup> . Supply feeding to the temperature sensor from the HostMCU PD_14 when it is set to '1'. PD_14 Push-Pull output circuitry limits the current to the sensor.
R53	HostMCU 32 kHz RTC link	●	Links RTC crystal to the HostMCU
R56	Application section 3.3VDC PSU control	●	Links the HostMCU PE_0 port to control 3.3VDC PSU. '0':disable, '1':enable
R59	HostMCU reset pull up	○	The application section reset circuitry pull up resistor
R60	HostMCU 32KHz RTC link	●	Links RTC crystal to the HostMCU
R61	HostMCU 12MHz XTAL link	●	The HostMCU 12 MHz crystal link

<sup>2</sup> ●: Connected/populated, ○: Not connected/open

<sup>3</sup> Provisional feature (Module current consumption): instrumenting the current consumption of the Cellular and GNSS Modules from the InterfaceMCU to characterize and instrument the application behavior during development.

<sup>4</sup> Provisional feature (I2C Bus Access): accessing Application section sensors and devices on the HostMCU I2C3 Bus from InterfaceMCU to characterize and instrument the application behavior during development.

<sup>5</sup> The Si7034-A10 is a Temperature and Relative Humidity Sensor. The HostMCU PD\_4 port cannot provide enough current to the sensor to run the Humidity sensor's heating element. So, the Humidity feature of the sensor shall not be used.

Name	Function	Variant <sup>2</sup> R412M	Description
R63	IC19 BQ27441 BIN pull up link to BQVDD	○	Provisional
R68	HostMCU BOOT0 pull down	●	HostMCU BOOT0 10 kΩ pull down to ground for input setting to '0'
R73	GNSS module backup supply by-pass	○	ZOE-M8B V_BCKP by-pass
R77	Cellular module voltage translator supply	●	Voltage translator supply level for the cellular module side for the HostMCU USART1 communication. Link the translator supply input to cellular module's V_INT internal supply output
R78	Cellular module voltage translator supply	○	Voltage translator supply level for the cellular module side for the HostMCU USART1 communication. Link the translator supply input to the application section supply rail VSYS
R79	LiPo battery charging link	●	Battery charging and management circuitry link to LiPo battery for charging
R86	Cellular signal pull down	○	Provisional
R95	Cellular module UB_M_PWRON to M_VBCKUP link	○	100 kΩ connection between M_VBCKUP and UB_M_PWRON nets
R96	Cellular module V_BCKP link	○	Link to M_VBCKUP net
R97	Cellular module PWR_ON link	●	The HostMCU PD_2 port UB_M_PWRON signal to cellular module PWR_ON pin
R99	The HostMCU PC_11port to cellular module GPIO1 link	○	Not functional
R100	Serial USB sniffer to cellular module GPIO1 link	●	Not functional
R101	Cellular module USB VBUS link	●	Cellular module VUSB_DET
R102	Cellular module GPIO2 link	●	Link to the HostMCU PD_1 port
R103	Cellular module GPIO4 link	●	Not functional
R104	Cellular module USB Data_N signal link	●	Cellular module USB signal to J7 cellular module USB connector
R105	HostMCU USART1 Tx link	●	When removed isolates HostMCU USART1 Tx pin PA_9 from the cellular module. Could be used in a configuration to drive the cellular module from the serial USB sniffer directly.
R107	Cellular module USB Data_P signal link	●	Cellular module USB signal to J7 cellular module USB connector
R108	InterfaceMCU PSU EN reference	○	PSU EN voltage threshold voltage divider resistor
R111	HostMCU USART1 Rx link	●	When removed isolates HostMCU USART1 Rx pin PA_10 from the cellular module Could be used in a configuration to drive the cellular module from the serial USB sniffer directly
R112	IC19 BQ27441 BIN link to LiPo battery	○	Provisional
R113	Cellular module I2C SCL link	○	Not functional
R114	Cellular module I2C SDA link	○	Not functional
R115	Cellular Module GPIO2 option	○	Cellular module GPIO2 to ground
R116	Cellular Module Pin 21 option	●	Cellular module Pin 21 to ground
R117	Cellular Module RSVD pin option	●	Cellular module RSVD pin to ground
R119	Arduino™ Uno R3 interface A5 pin I2C provision	○	Link to Arduino™ Uno R3 interface SCL pin
R120	Arduino™ Uno R3 interface A4 pin I2C provision	○	Link to Arduino™ Uno R3 interface SDA pin
R121	GNSS PPS LED G3 disable option	○	Link to LED
R123	GPS_RST net link	○	Provisional
R124	HostMCU 1.8V Backup Battery link	●	Links the 1.8V battery backed supply rail to the HostMCU 4 kB of battery backed SRAM
R131	IC20 BQ24295 QON Pull down	○	Provisional

Name	Function	Variant <sup>2</sup> R412M	Description
R132	InterfaceMCU level translator OE to 3.3VDC	○	Links OE input of the level translator to 3.3VDC
R133	HostMCU USART2 virtual COM Rx link	●	Link to InterfaceMCU USART2 Rx signal through 1.8V to 3.3V level translator
R134	HostMCU USART2 virtual COM Tx link	●	Link to InterfaceMCU USART2 Tx signal through 1.8V to 3.3V level translator
R135	HostMCU external system clock (Osc.) link	○	Link to 8 MHz clock generated from InterfaceMCU to drive the HostMCU
R136	HostMCU USART2 USB sniffer Tx link	●	Link to serial USB sniffer Rx input
R137	HostMCU USART2 USB sniffer Rx link	○	Link to serial USB sniffer Tx output
R142	InterfaceMCU 3.3VDC supply sampling	○	Utilised for monitoring InterfaceMCU 3.3VDC supply level
R143	InterfaceMCU level translator OE GND link	○	Links OE input of the level translator to GND to disable the translator
R144	HostMCU PA_0 pull up	○	HostMCU PA_0-WKUP pin setting
R145	HostMCU BOOT1 pull up	●	HostMCU BOOT1 input setting to '1'
R146	HostMCU BOOT0 pull up	○	HostMCU BOOT0 input setting to '1'
R147	Serial USB sniffer reset link	○	Link between serial USB sniffer's reset input to the application section reset signal
R149	Cellular Module DTR pull down	●	SARA-R412M DTR input pull down
R150	The Si7034-A10 is a Temperature and Relative Humidity Sensor power link	○	Link to 1.8VDC supply rail. See R48 link for utilization.
R151	Arduino™ interface 1.8V IO supply option	○	Provisional
R152	Arduino™ interface IOREF voltage level selection for 3.3VDC	●	Link to Arduino™ interface 3.3V pin
R153	Arduino™ interface IOREF voltage level selection for 5VDC	○	Link to Arduino™ interface 5V pin
R154	Arduino™ interface 5V pin to USB5V rail	●	USB5V supply link for Arduino™ interface
R160	M_GPIO3 net to PB8 link	○	Link to Arduino™ interface
R161	M_GPIO4 net to PB15 link	○	Link to Arduino™ interface
R162	GPS_PPS net to cellular module GPIO1 link	●	Link to SARA-R412M GPIO1
R164	IC22 output link to GNSS module	○	Provisional
R165	1V8_ZOE supply link to GNSS module	●	1.8V Supply rail to ZOE-M8B
R167	IC22 100k resistor	○	Provisional
R168	M_GPIO3 net link to cellular module	●	Link to SARA-R412M GPIO3
R170	M_VINT net link to cellular module GPIO5	○	Link to SARA-R412M GPIO5
R171	Arduino™ interface D5 pin to IC10 link	●	Provisional isolation
R172	IC10 A6 pin to PA5 link	●	Provisional isolation
R173	PA5 to Arduino™ interface D5 pin direct link	○	Provisional
R174	USART1_TX net USB sniffer link	●	Link to S2 switch
R175	I_GNSS signal connection to Arduino™ interface A1	○	Provisional
R178	PC8 link to Arduino™ interface D4	●	Link to Arduino™ interface
R179	PB1 connection to Arduino™ interface D4	○	Provisional for backward compatibility
R180	Cellular module M_SCL net to Arduino™ interface SCL pin	○	Provisional
R181	Cellular module M_SDA net to Arduino™ interface SDA pin	○	Provisional





## 2.6 Test, break out points, and debug interfaces

The C030-R412M has test and break out points to access key signals of the circuitry as well as interface and Host MCU debug interfaces placed on the bottom side of the PCB for easy access. These are listed in [Table 5](#) and depicted in [Figure 6](#).

Name	Signal
01	Cellular module supply voltage
02	GNSS module supply voltage
03	InterfaceMCU SWDCLK
04	InterfaceMCU SWDIO
05	InterfaceMCU reset
06	3.3 VDC supply for InterfaceMCU
07	OE signal for IC4 level translator between utility and application sections
08 to 19	N/A
20	1.8VDC supply for Host MCU
21	Host MCU SWDIO
22	Host MCU Reset
23	Host MCU SWDCLK
24	Host MCU BOOT0
44	Cellular module pin 44 break-out (SPK_P). Unused
45	Cellular module pin 45 break-out (SPK_N). Unused
46	Cellular module pin 46 break-out (MIC_BIAS). Unused
47	Cellular module pin 47 break-out (MIC_GND). Unused
48	Cellular module pin 48 break-out (MIC_N). Unused
49	Cellular module pin 49 break-out (MIC_P). Unused
RSVDS1	Cellular module pin 19 break-out (RSVD, Reserved). Unused
ST-SWD1	Tag-Connect-NL Plug-of-Nails™ connector compatible PCB touch points footprint for Interface MCU
SWD_TGT1	Tag-Connect-NL Plug-of-Nails™ connector compatible PCB touch points footprint for Host MCU

**Table 5: C030-R412M test and break out points and debug interfaces**

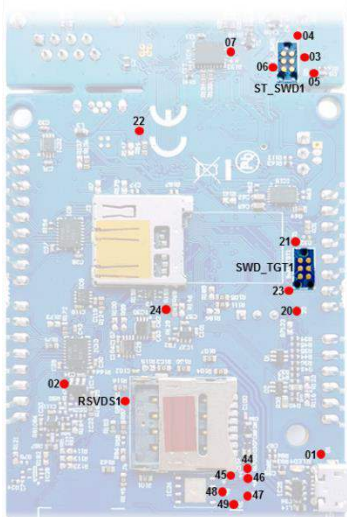

**Figure 6: C030-R412M test and break out points and debug interfaces (bottom view)**

## 2.7 Arduino™ UNO R3 compatible interface pin out

C030-R412M Arduino™ compatible interface details are given in [Table 6](#) and shown in [Figure 7](#).

Conn.	Pin N°	Arduino naming	Description	HostMCU port assignment	Alternate functions and notes
Ard1A	1	n.c.	Not connected		
	2	IOREF	IO reference voltage level. Connected to 3.3 VDC		Could be used as input for external IO level setting.
	3	nR	Reset signal input. Negative logic		
	4	3.3V	3.3 VDC supply output		Controlled by HostMCU Port PE_0 0: disable, 1:enable
	5	5V	5 VDC Reference input		Could be used as IO Reference input
	6	GND	Ground level		
	7	GND	Ground level		
	8	VIN	External DC supply input	In the range of 2.5 VDC to 5.5 VDC	See Jumper J1 in section <a href="#">2.4</a>
Ard1B	9	A0	Analog input	PA_3 Analog input <sup>6</sup>	GPIO, Ext. interrupt
	10	A1	Analog input	PC_0 Analog input <sup>6</sup>	GPIO, Ext. interrupt
	11	A2	Analog input	PC_3 Analog input <sup>6</sup>	GPIO, Ext. interrupt
	12	A3	Analog input	PA_4 Analog input <sup>6</sup>	GPIO, Ext. interrupt
	13	A4	Analog input	PA_6 Analog input <sup>6</sup> , PB_7 I2C1 SDA <sup>7</sup>	GPIO, Ext. interrupt
	14	A5	Analog input	PB_0 Analog input <sup>6</sup> , PB_6 I2C1 SCL <sup>8</sup>	GPIO, Ext. interrupt
Ard1C	15	D0	Digital I/O, UART RX	PD_9, USART3_TX	GPIO, Ext. interrupt
	16	D1	Digital I/O, UART TX	PD_8, USART3_RX	GPIO, Ext. interrupt
	17	D2	Digital I/O	PD_11	USART3_CTS, GPIO, External interrupt
	18	D3	Digital I/O	PB_14	USART3_RTS, GPIO, PWM, Ext. interrupt
	19	D4	Digital I/O	PC_8	GPIO, PWM, Ext. interrupt
	20	D5	Digital I/O	PA_5	GPIO, PWM, Ext. interrupt
	21	D6	Digital I/O	PB_8	GPIO, PWM, Ext. interrupt
	22	D7	Digital I/O	PB_15	GPIO, PWM, Ext. interrupt
	23	D8	Digital I/O	PD_15	GPIO, Ext. interrupt
	24	D9	Digital I/O	PD_12	GPIO, Ext. interrupt
Ard1D	25	D10 <sup>9</sup>	Digital I/O	PE_11, SPI4 NSS, shared with SD Card	GPIO, PWM, Ext. interrupt
	26	D11	Digital I/O	PE_6, SPI4 MOSI, shared with SD Card	GPIO, PWM, Ext. interrupt
	27	D12	Digital I/O	PE_5, SPI4 MISO, shared with SD Card	GPIO, PWM, Ext. interrupt
	28	D13	Digital I/O	PE_2, SPI4 SCK, shared with SD Card	GPIO, Ext. interrupt
	29	GND	Ground level		
	30	AREF	3.3 VDC reference		
	31	SDA	I2C SDA I/O	PB_6 I2C1 SCL	GPIO, Ext. interrupt
	32	SCL	I2C SCL Output	PB_7 I2C1 SDA	GPIO, Ext. interrupt

**Table 6: C030-R412M Arduino UNO R3 compatible interface**

<sup>6</sup> Pin is connected to the port via 1 k $\Omega$ /1 k $\Omega$  resistive voltage divider.

<sup>7</sup> PB\_7 could be connected to the (A4) Ard1B pin 13 to provide I2C1 SDA signal.

<sup>8</sup> PB\_6 could be connected to the (A5) Ard1B pin 14 to provide I2C1 SCL signal.

<sup>9</sup> Arduino interface D10 to D13 pins are used as an SPI Bus to HostMCU SPI4 peripheral. The D10 to D13 pins are shared with the SD card socket.

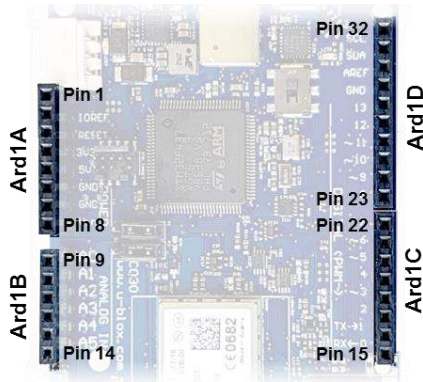



Figure 7: C030-R412M Arduino™ UNO R3 connectors

## 2.8 Power supply options and LiPo battery usage

The C030-R412M can be powered up from several resources, individually or all together. The power supply usage configurations are provided in [Table 7](#).

#	Connector	Description
1	Debug USB	Uses development PC's USB 5 VDC VBUS to power up the utility and application sections of the C030-R412M. It charges up the LiPo battery if it is connected.
2	Aux 5V USB	Auxiliary USB power input. A USB power supply could be connected to power up only the application section of the C030-R412M. It charges up the LiPo battery if it is connected. There is no communication functionality.
3	Serial USB sniffer	Uses Development PC's USB 5 VDC VBUS to power up only the application section of the C030. It charges up the LiPo battery if it is connected. The serial USB sniffer circuitry could only be powered from its dedicated USB connector.
4	LiPo battery	The C030 application section could run only from a LiPo Battery connected. If one or many of the #1, #2, #3 USB connections are available. The LiPo Battery is charged up as well.
5	Arduino™ UNO R3 VIN Pin 8	Arduino™ UNO R3 VIN pin 8 could be used to power up entire the C030 application section except serial USB sniffer circuitry. STLink (or CMSIS-DAP when available) feature could be used through the debug USB. However, the C030-R412M application section including LiPo Battery management circuitry is disconnected. The VIN input voltage should be in the range of 2.5 VDC to 5.5 VDC.

Table 7: C030 power supply options and LiPo battery usage

 The C030-R412M could run on a single supply input from #1 debug USB or #3 serial USB sniffer. However, the cellular module transmission power demand might not be satisfied from these connections. In such a use case, the C030-R412M might suffer brownout due to USB VBUS supply rail cuts because of USB current limitations. Therefore, either a 5 VDC USB power supply with ~3 ADC capacity should be connected to the Aux 5V USB connector and/or an adequate LiPo battery, such as a BAK LP-503759-IS-3, should be connected to the LiPo battery connector. The locations of the power supply connections are shown in [Figure 8](#).

It is recommended to use a LiPo battery in addition to the USB connections, because high frequency current demands might not be provided by the USB VBUS rails.

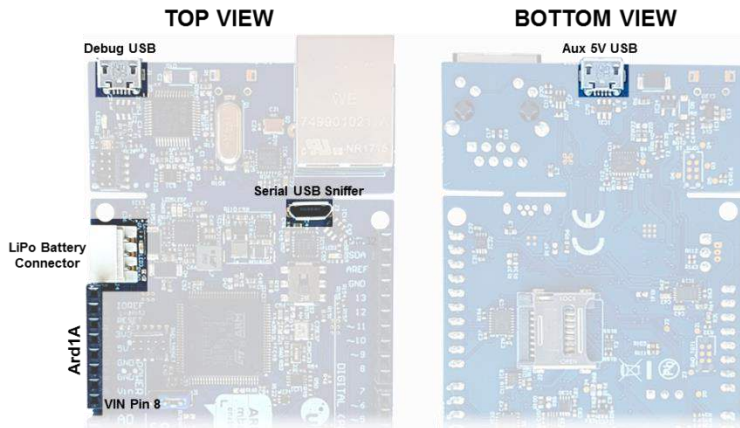

Figure 8: C030 power supply connection options

## 3 Getting started

### 3.1 C030-R412M board setup

1. Connect the Main cellular antenna to the cellular main antenna SMA female connector (ANT1).
2. Connect the GNSS antenna to the GNSS antenna SMA female.
3. Configure the C030-R412M as described in section 2.2.
4. Power up the C030-R412M as described in section 2.8.

### 3.2 Development PC USB driver configuration

Although the USB drivers can be loaded by the development PC operating system automatically, it is recommended to follow the guidelines mentioned below:

- The debug USB port STLink/V2-1 interface needs a driver. These drivers are available at: [http://www.st.com/content/st\\_com/en/products/embedded-software/development-tool-software/stsw-link009.html](http://www.st.com/content/st_com/en/products/embedded-software/development-tool-software/stsw-link009.html).
- Similarly, the cellular modem USB sniffer USB port interface needs a driver, which is available at: <http://www.silabs.com/products/interface/usb-bridges/classic-usb-bridges/device.cp2105>

### 3.3 Getting started with Mbed

Up-to-date information on how to operate the C030-R412M starter kit within the Mbed development environment is available at:

- <https://developer.mbed.org/platforms/ublox-C030-R412M/>  
(Link forwards automatically to the site <https://os.mbed.com/platforms/ublox-C030-R410M/>)

## 4 Approvals

 For the detailed list of Radio Access Technologies and bands included in each certification approval of the SARA-R412M modules, and for detailed instructions about how to configure the SARA-R412M modules for certification approvals compliance perspective, see the Approvals sections of the SARA-R4/SARA-N4 series System Integration Manual [\[2\]](#).

### 4.1 European Conformance

The C030-R412M application board has been evaluated against the essential requirements of the 2014/53/EU Radio Equipment Directive.

In order to satisfy the essential requirements of the 2014/53/EU Radio Equipment Directive, the device is compliant with the following standards:



- Radio Frequency spectrum use (Article 3.2):
  - EN 301 511
  - EN 301 908-1
  - EN 301 908-13
  - EN 303 413
- Electromagnetic Compatibility (Article 3.1b):
  - EN 301 489-1
  - EN 301 489-19
  - EN 301 489-52
- Health and Safety (Article 3.1a)
  - EN 62311
  - EN 62368-1
  - EN 60950-1

The conformity assessment procedure for C030-R412M application boards, referred to in Article 17 and detailed in Annex III of Directive 2014/53/EU, has been followed.

Thus, the following marking is included in the product:



There are no restrictions for the commercialization of the C030-R412M application boards in all the countries of the European Union.

-  Radiofrequency radiation exposure Information: this equipment complies with radiation exposure limits prescribed for an uncontrolled environment for fixed and mobile use conditions. This equipment should be installed and operated with a minimum distance of 20 cm between the radiator and the body of the user or nearby persons. This transmitter must not be collocated or operating in conjunction with any other antenna or transmitter except as authorized in the certification of the product.
-  The gain of the cellular system antenna(s) used for C030-R412M application boards (i.e. the combined transmission line, connector, cable losses and radiating element gain) must not exceed 8.2 dBi in the 800 MHz band (i.e. LTE FDD-20 band), 3.21 dBi in the 900 MHz band (i.e. GSM 900 or LTE FDD-8 band), 9.09 dBi in the 1800 MHz band (i.e. GSM 1800 or LTE FDD-3 band) for mobile and fixed or mobile operating configurations.

## 4.2 US Federal Communications Commission notice

United States Federal Communications Commission (FCC) IDs:

- XPYUBX18ZO01

 Radiofrequency radiation exposure Information: this equipment complies with radiation exposure limits prescribed for an uncontrolled environment for fixed and mobile use conditions. This equipment should be installed and operated with a minimum distance of 20 cm between the radiator and the body of the user or nearby persons. This transmitter must not be collocated or operating in conjunction with any other antenna or transmitter except as authorized in the certification of the product.

 The gain of the cellular system antenna(s) used for C030-R412M application boards (i.e. the combined transmission line, connector, cable losses and radiating element gain) must not exceed 8.69 dBi in the 700 MHz band (i.e. the LTE FDD-12 band), 9.15 dBi in the 750 MHz band (i.e. the LTE FDD-13 band), 9.41 dBi in the 850 MHz band (i.e. the GSM 850 / LTE FDD-5 band), 12.01 dBi in the 1700 MHz band (i.e. the LTE FDD-4 band), 12.01 dBi in the 1900 MHz band (i.e. the GSM 1900 / LTE FDD-2 band) for mobile and fixed or mobile operating configurations.

## 4.3 Innovation, Science, Economic Development Canada notice

ISED Canada (formerly known as IC - Industry Canada) Certification Numbers:

- 8595A-UBX18ZO01

 Radiofrequency radiation exposure Information: this equipment complies with radiation exposure limits prescribed for an uncontrolled environment for fixed and mobile use conditions. This equipment should be installed and operated with a minimum distance of 20 cm between the radiator and the body of the user or nearby persons. This transmitter must not be collocated or operating in conjunction with any other antenna or transmitter except as authorized in the certification of the product.

 The gain of the cellular system antenna used for the C030-R412M application boards (i.e. the combined transmission line, connector, cable losses and radiating element gain) must not exceed 5.63 dBi in the 700 MHz band (i.e. the LTE FDD-12 band), 5.94 dBi in the 750 MHz band (i.e. the LTE FDD-13 band), 6.12 dBi in the 850 MHz band (i.e. the GSM 850 / LTE FDD-5 band), 8.29 dBi in the 1700 MHz band (i.e. the LTE FDD-4 band), 8.52 dBi in the 1900 MHz band (i.e. the GSM 1900 / LTE FDD-2 band) for mobile and fixed or mobile operating configurations.



# Appendix

## A Glossary

Abbreviation	Definition
Arm	Arm (Advanced RISC Machines) Holdings
CE	Certification Mark for EHS compliance in the European Economic Area
CTS	Clear To Send
eUICC	embedded SIM
FCC	Federal Communications Commission
FDD	Frequency Division Duplex
GLONASS	Global Navigation Satellite System
GND	Ground
GNSS	Generic Navy Simulation System
GPIO	General Purpose Input Output
GSM	Global System for Mobile Communication
HSPA	High Speed Packet Access
I2C	Inter-Integrated Circuit
IoT	Internet of Things
ISED	Innovation Science Economic Development
LTE	Long Term Evolution
PCB	Printed Circuit Board
PWM	Pulse Width Modulation
RAM	Random Access Memory
RTS	Request To Send
SCL	Serial Clock
SDA	Serial Data
SIM	Subscriber Identification Module
SiP	System in Package
SPI	Serial Peripheral Interface
UART	Universal Asynchronous Receiver-Transmitter
USB	Universal Serial Bus

**Table 8: Explanation of the abbreviations and terms used**

## Related documents

- [1] u-blox SARA-R4/SARA-N4 series Data Sheet, Doc. No. [UBX-16024152](#)
- [2] u-blox SARA-R4/SARA-N4 series System Integration Manual, Doc. No. [UBX-16029218](#)
- [3] u-blox Nested Design Application Note, Doc. No. [UBX-16007243](#)

 For regular updates to u-blox documentation and to receive product change notifications, register on our homepage ([www.u-blox.com](http://www.u-blox.com)).

## Revision history

Revision	Date	Name	Comments
R01	01-Jul-2019	euyg	Initial release

# Contact

For complete contact information, visit us at [www.u-blox.com](http://www.u-blox.com).

## u-blox Offices

### North, Central and South America

#### u-blox America, Inc.

Phone: +1 703 483 3180

E-mail: [info\\_us@u-blox.com](mailto:info_us@u-blox.com)

#### Regional Office West Coast:

Phone: +1 408 573 3640

E-mail: [info\\_us@u-blox.com](mailto:info_us@u-blox.com)

#### Technical Support:

Phone: +1 703 483 3185

E-mail: [support@u-blox.com](mailto:support@u-blox.com)

### Headquarters

#### Europe, Middle East, Africa

#### u-blox AG

Phone: +41 44 722 74 44

E-mail: [info@u-blox.com](mailto:info@u-blox.com)

Support: [support@u-blox.com](mailto:support@u-blox.com)

### Asia, Australia, Pacific

#### u-blox Singapore Pte. Ltd.

Phone: +65 6734 3811

E-mail: [info\\_ap@u-blox.com](mailto:info_ap@u-blox.com)

Support: [support\\_ap@u-blox.com](mailto:support_ap@u-blox.com)

#### Regional Office Australia:

Phone: +61 2 8448 2016

E-mail: [info\\_au@u-blox.com](mailto:info_au@u-blox.com)

Support: [support\\_ap@u-blox.com](mailto:support_ap@u-blox.com)

#### Regional Office China (Beijing):

Phone: +86 10 68 133 545

E-mail: [info\\_cn@u-blox.com](mailto:info_cn@u-blox.com)

Support: [support\\_cn@u-blox.com](mailto:support_cn@u-blox.com)

#### Regional Office China (Chongqing):

Phone: +86 23 6815 1588

E-mail: [info\\_cn@u-blox.com](mailto:info_cn@u-blox.com)

Support: [support\\_cn@u-blox.com](mailto:support_cn@u-blox.com)

#### Regional Office China (Shanghai):

Phone: +86 21 6090 4832

E-mail: [info\\_cn@u-blox.com](mailto:info_cn@u-blox.com)

Support: [support\\_cn@u-blox.com](mailto:support_cn@u-blox.com)

#### Regional Office China (Shenzhen):

Phone: +86 755 8627 1083

E-mail: [info\\_cn@u-blox.com](mailto:info_cn@u-blox.com)

Support: [support\\_cn@u-blox.com](mailto:support_cn@u-blox.com)

#### Regional Office India:

Phone: +91 80 405 092 00

E-mail: [info\\_in@u-blox.com](mailto:info_in@u-blox.com)

Support: [support\\_in@u-blox.com](mailto:support_in@u-blox.com)

#### Regional Office Japan (Osaka):

Phone: +81 6 6941 3660

E-mail: [info\\_jp@u-blox.com](mailto:info_jp@u-blox.com)

Support: [support\\_jp@u-blox.com](mailto:support_jp@u-blox.com)

#### Regional Office Japan (Tokyo):

Phone: +81 3 5775 3850

E-mail: [info\\_jp@u-blox.com](mailto:info_jp@u-blox.com)

Support: [support\\_jp@u-blox.com](mailto:support_jp@u-blox.com)

#### Regional Office Korea:

Phone: +82 2 542 0861

E-mail: [info\\_kr@u-blox.com](mailto:info_kr@u-blox.com)

Support: [support\\_kr@u-blox.com](mailto:support_kr@u-blox.com)

#### Regional Office Taiwan:

Phone: +886 2 2657 1090

E-mail: [info\\_tw@u-blox.com](mailto:info_tw@u-blox.com)

Support: [support\\_tw@u-blox.com](mailto:support_tw@u-blox.com)