

## LISA2-WWW-PIN

~80° wide beam optimized for LUXEON Rebel.  
6.6 mm high variant with location pin  
installation.

### SPECIFICATION:

Dimensions	Ø 9.9 mm
Height	6.6 mm
Fastening	glue, pin
ROHS compliant	yes ⓘ



### MATERIALS:

Component	Type	Material	Colour	Finish
LISA2-WWW	Single lens	PMMA	clear	
LISA2-HLD-PIN-RE	Holder	PC	black	



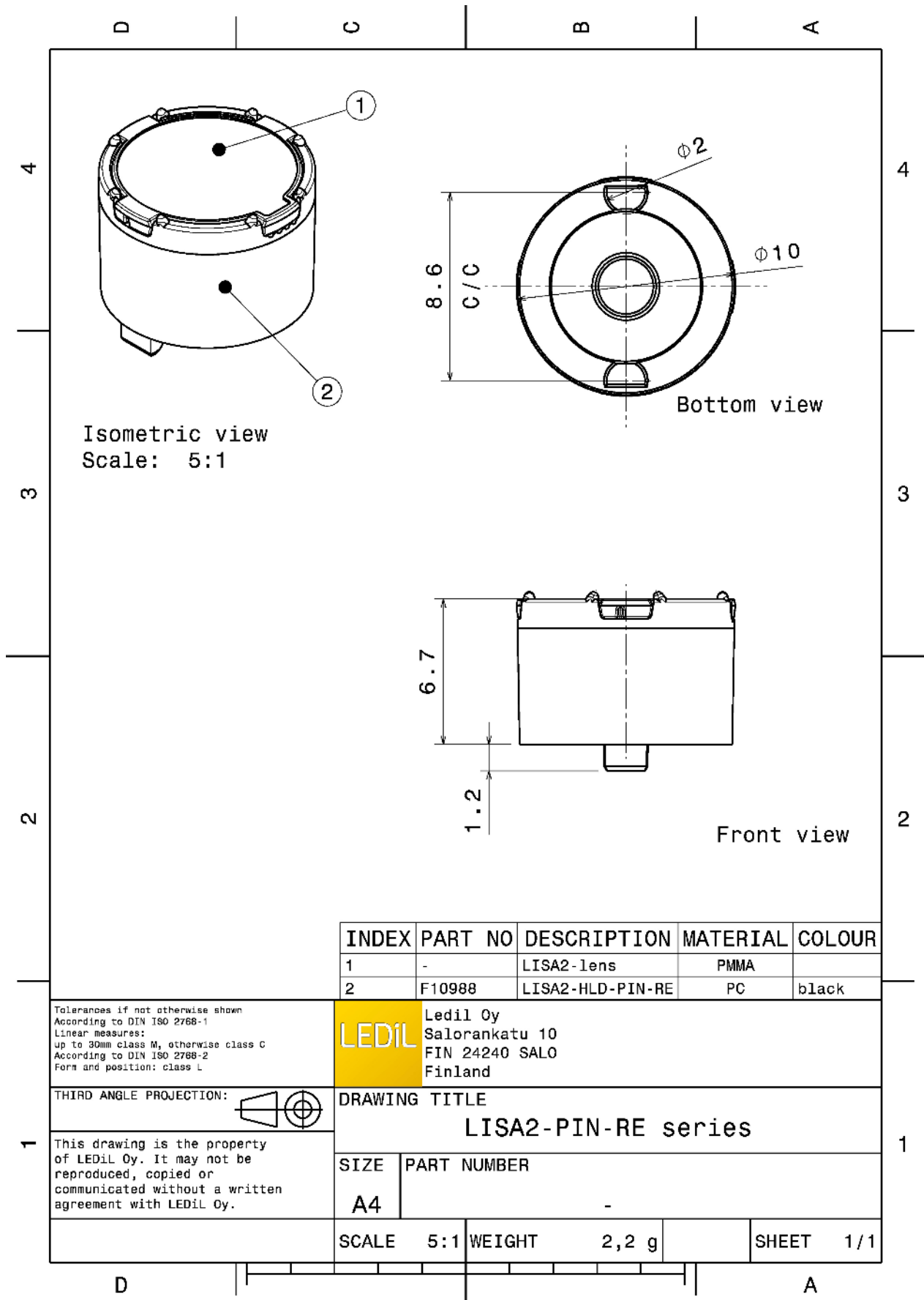

### ORDERING INFORMATION:

Component		Qty in box	MOQ	MPQ	Box weight (kg)
FP11951_LISA2-WWW-PIN	Single lens	2000		100	1.4
» Box size:					

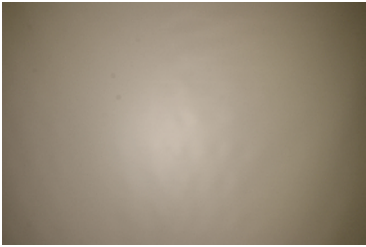
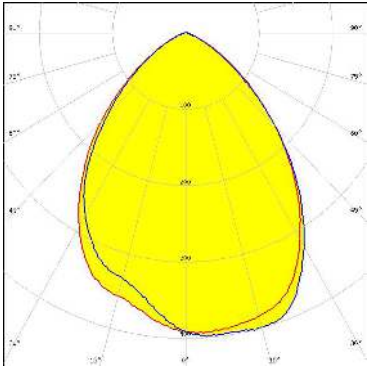

See also our general installation guide: [www.ledil.com/installation\\_guide](http://www.ledil.com/installation_guide)

#### OPTICAL RESULTS (MEASURED):

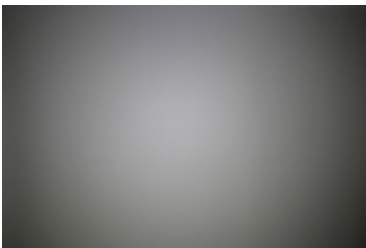
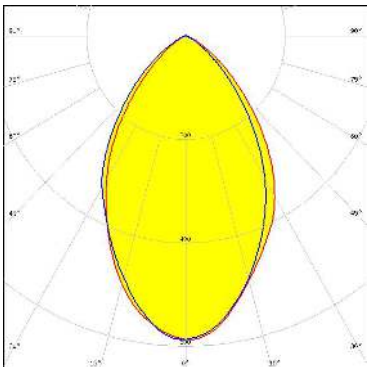
		
LED	LUXEON Rebel	
FWHM / FWTM	80.0°	
Efficiency	79 %	
LEDs/each optic	1	
Light colour	White	
Required components:		
		
LED	NCSxx19A	
FWHM / FWTM	76.0° / 118.0°	
Efficiency	79 %	
Peak intensity	0.5 cd/lm	
LEDs/each optic	1	
Light colour	White	
Required components:		
		
LED	NVSxx19B/NVSxx19C	
FWHM / FWTM	83.0° / 123.0°	
Efficiency	69 %	
Peak intensity	0.4 cd/lm	
LEDs/each optic	1	
Light colour	White	
Required components:		
		
		
		
LED	LH181A	
FWHM / FWTM	68.0° / 110.0°	
Efficiency	73 %	
Peak intensity	0.6 cd/lm	
LEDs/each optic	1	
Light colour	White	
Required components:		
		
		

### OPTICAL RESULTS (MEASURED):

#### SAMSUNG

LED LH181B  
FWHM / FWTM 73.0° / 114.0°  
Efficiency 75 %  
Peak intensity 0.6 cd/lm  
LEDs/each optic 1  
Light colour White  
Required components:

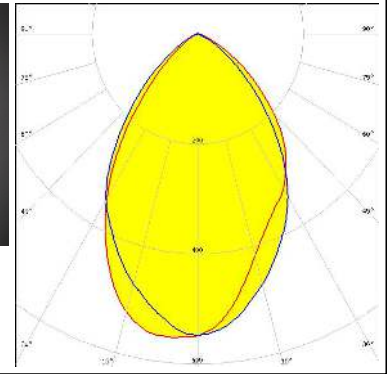
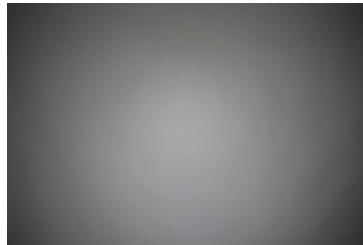

#### OPTICAL RESULTS (SIMULATED):



LED	LUXEON IR 2720
FWHM / FWTM	57.0° / 105.0°
Efficiency	82 %
Peak intensity	0.8 cd/lm
LEDs/each optic	1
Light colour	IR
Required components:	

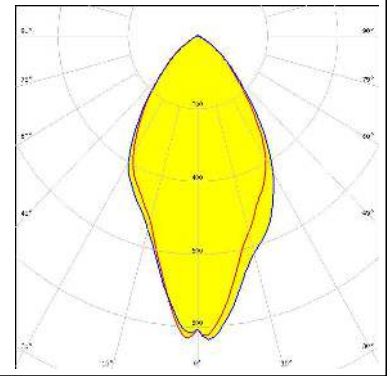

### GENERAL INFORMATION:

NOTE: The typical beam angle will be changed by different color, chip size and chip position tolerance. The typical total beam angle is the full angle measured where the luminous intensity is half of the peak value.

### MATERIALS:

As part of our continuous research and improvement processes, and to ensure the best possible quality and availability of our products, LEDiL reserves the right to change material grades without notice.

### PRODUCT DATA USER AGREEMENT AND DISCLAIMER:

The measured data in the provided downloadable LEDiL Product Datasheets and Mechanical 2D-Drawings is rounded and provided as reference for planning. LEDiL Oy's optical specifications have been verified by conducting performance testing of the products in accordance with the company's quality system. The reported data are averaged results of multiple measurements with typical variation. LEDiL Oy reserves the right to without prior notification make changes and improvements to its products.

LEDiL Oy assumes neither warranty, nor guarantee nor any other liability of any kind for the contents and correctness of the provided data. The provided data has been generated with highest diligence but the provided data may in reality not represent the complete possible variation range of all intrinsic parameters. Therefore, in certain cases a deviation from the provided data could occur.

LEDiL Oy reserves the right to undertake technical changes of its products without further notification which could lead to changes in the provided data. LEDiL Oy assumes no liability of any kind for the possible deviation from any provided data or any other damage resulting from the usage of the provided data.

The user agrees to this disclaimer and user agreement with the download or usage of the provided files.

#### LEDiL Oy

Joensuunkatu 13  
FI-24240 SALO  
Finland

#### LEDiL Inc.

228 West Page Street  
Suite D  
Sycamore IL 60178  
USA

#### Ledil Optics Technology (Shenzhen) Co., Ltd.

# 405 , Block B  
Casic Motor Building  
Shenzhen 518057  
P.R.CHINA

#### Local sales and technical support

[www.ledil.com/  
where\\_to\\_buy](http://www.ledil.com/where_to_buy)

#### Shipping locations

Salo, Finland  
Hong Kong, China

#### Distribution Partners

[www.ledil.com/  
where\\_to\\_buy](http://www.ledil.com/where_to_buy)