

Small switching (60V, 10A)

2SK2095N

●Features

- 1) Low on-resistance.
- 2) Fast switching speed.
- 3) Wide SOA (safe operating area).
- 4) Easily designed drive circuits.
- 5) Low $V_{GS(th)}$.
- 6) Easy to parallel.

●Structure

Silicon N-channel
MOSFET

●External dimensions (Units: mm)

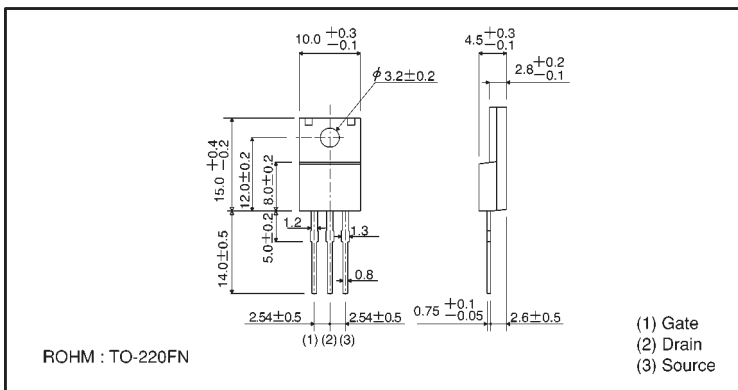

●Absolute maximum ratings ($T_a = 25^\circ\text{C}$)

Parameter	Symbol	Limits	Unit
Drain-source voltage	V_{DS}	60	V
Gate-source voltage	V_{GS}	± 20	V
Drain current	Continuous	I_D	10 A
	Pulsed	I_{DP}^*	40 A
Reverse drain current	Continuous	I_{DR}	10 A
	Pulsed	I_{DRP}^*	40 A
Total power dissipation ($T_c=25^\circ\text{C}$)	P_D	30	W
Channel temperature	T_{ch}	150	$^\circ\text{C}$
Storage temperature	T_{stg}	$-55 \sim +150$	$^\circ\text{C}$

* $P_w \leq 10 \mu\text{s}$, Duty cycle $\leq 1\%$

●Packaging specifications

Type	Package	Bulk
	Code	—
	Basic ordering unit (pieces)	500
2SK2095N		○

●Electrical characteristics (Ta = 25°C)

Parameter	Symbol	Min.	Typ.	Max.	Unit	Test Conditions
Gate-source leakage	I _{GSS}	—	—	±100	nA	V _{GS} =±20V, V _{DS} =0V
Drain-source breakdown voltage	V _{(BR)DSS}	60	—	—	V	I _D =1mA, V _{GS} =0V
Zero gate voltage drain current	I _{DSS}	—	—	100	μA	V _{DS} =60V, V _{GS} =0V
Gate threshold voltage	V _{GS(th)}	1.0	—	2.5	V	V _{DS} =10V, I _D =1mA
Static drain-source on-state resistance	R _{DS(on)}	—	0.080	0.095	Ω	I _D =5A, V _{GS} =10V
		—	0.11	0.14		I _D =5A, V _{GS} =4V
Forward transfer admittance	Y _{fs} *	5.0	—	—	S	I _D =5A, V _{DS} =10V
Input capacitance	C _{iss}	—	1600	—	pF	V _{DS} =10V
Output capacitance	C _{oss}	—	600	—	pF	V _{GS} =0V
Reverse transfer capacitance	C _{rss}	—	150	—	pF	f=1MHz
Turn-on delay time	t _{d(on)}	—	30	—	ns	I _D =5A, V _{DD} ≠30V
Rise time	t _r	—	80	—	ns	V _{GS} =10V
Turn-off delay time	t _{d(off)}	—	300	—	ns	R _L =6Ω
Fall time	t _f	—	100	—	ns	R _G =10Ω

* P_w≤300 μs, Duty cycle≤1%

●Electrical characteristic curves

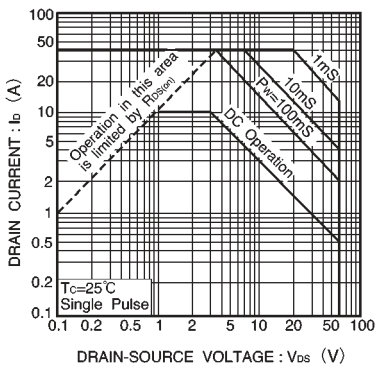

Fig.1 Maximum safe operating area

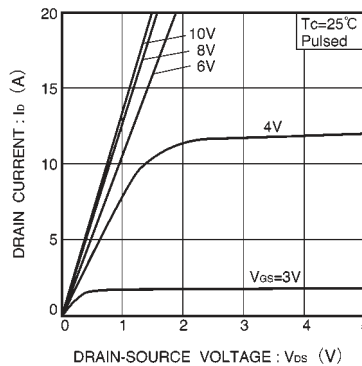

Fig.2 Typical output characteristics

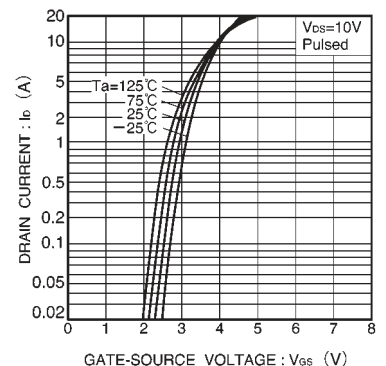

Fig.3 Typical transfer characteristics

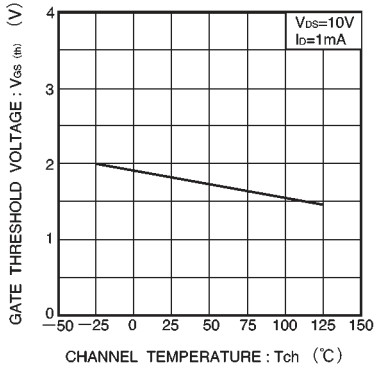

Fig.4 Gate threshold voltage vs. channel temperature

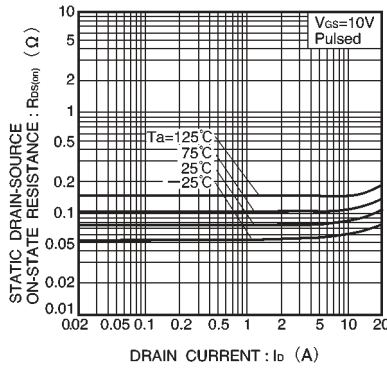

Fig.5 Static drain-source on-state resistance vs. drain current (I)

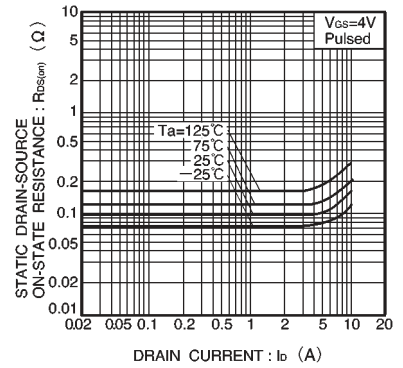

Fig.6 Static drain-source on-state resistance vs. drain current (II)

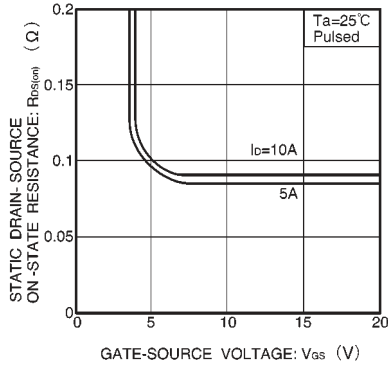

Fig.7 Static drain-source on-state resistance vs. gate-source voltage

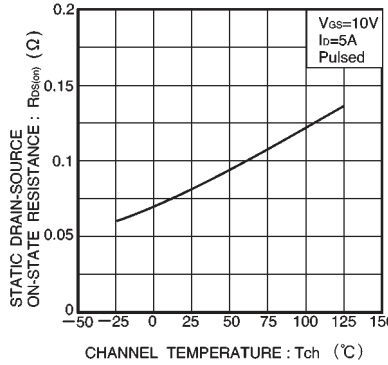

Fig.8 Static drain-source on-state resistance vs. channel temperature

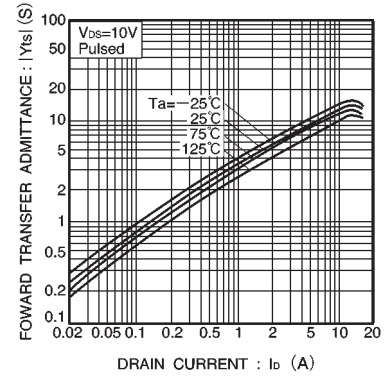

Fig.9 Forward transfer admittance vs. drain current

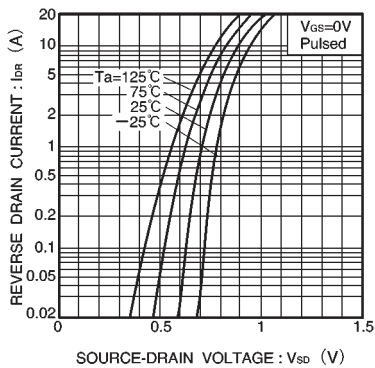

Fig.10 Reverse drain current vs. source-drain voltage (I)

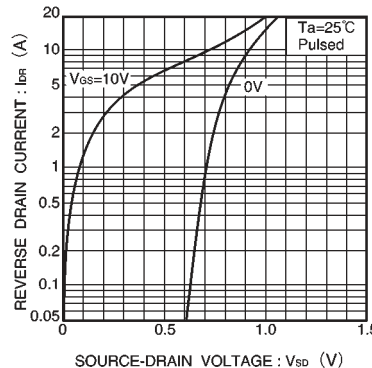

Fig.11 Reverse drain current vs. source-drain voltage (II)

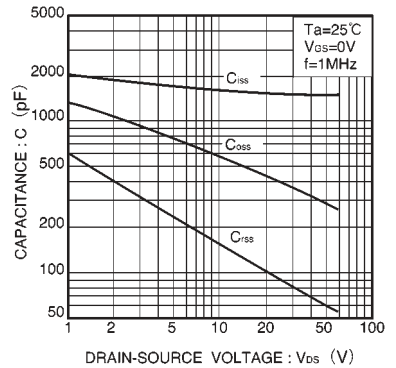

Fig.12 Typical capacitance vs. drain-source voltage

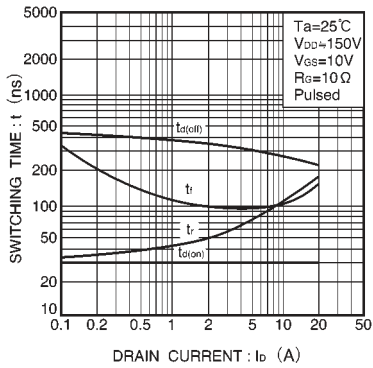

Fig.13 Switching characteristics
(See Figures 15 and 16 for the measurement circuit and resultant waveforms.)

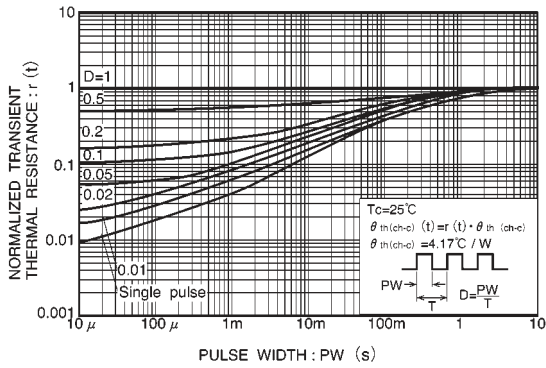

Fig.14 Normalized transient thermal resistance vs. pulse width

● Switching characteristics measurement circuit

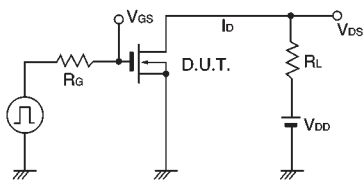

Fig.15 Switching time measurement circuit

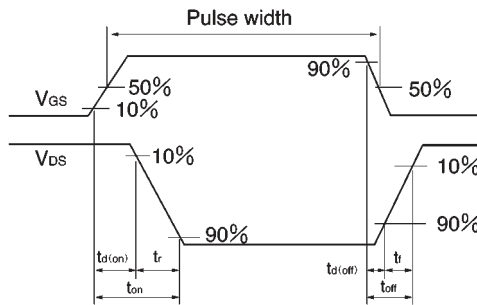

Fig.16 Switching time waveforms

Notes

- No technical content pages of this document may be reproduced in any form or transmitted by any means without prior permission of ROHM CO.,LTD.
- The contents described herein are subject to change without notice. The specifications for the product described in this document are for reference only. Upon actual use, therefore, please request that specifications to be separately delivered.
- Application circuit diagrams and circuit constants contained herein are shown as examples of standard use and operation. Please pay careful attention to the peripheral conditions when designing circuits and deciding upon circuit constants in the set.
- Any data, including, but not limited to application circuit diagrams information, described herein are intended only as illustrations of such devices and not as the specifications for such devices. ROHM CO.,LTD. disclaims any warranty that any use of such devices shall be free from infringement of any third party's intellectual property rights or other proprietary rights, and further, assumes no liability of whatsoever nature in the event of any such infringement, or arising from or connected with or related to the use of such devices.
- Upon the sale of any such devices, other than for buyer's right to use such devices itself, resell or otherwise dispose of the same, no express or implied right or license to practice or commercially exploit any intellectual property rights or other proprietary rights owned or controlled by
- ROHM CO., LTD. is granted to any such buyer.
- Products listed in this document use silicon as a basic material.
Products listed in this document are no antiradiation design.

The products listed in this document are designed to be used with ordinary electronic equipment or devices (such as audio visual equipment, office-automation equipment, communications devices, electrical appliances and electronic toys).

Should you intend to use these products with equipment or devices which require an extremely high level of reliability and the malfunction of which would directly endanger human life (such as medical instruments, transportation equipment, aerospace machinery, nuclear-reactor controllers, fuel controllers and other safety devices), please be sure to consult with our sales representative in advance.

About Export Control Order in Japan

Products described herein are the objects of controlled goods in Annex 1 (Item 16) of Export Trade Control Order in Japan.

In case of export from Japan, please confirm if it applies to "objective" criteria or an "informed" (by MITI clause) on the basis of "catch all controls for Non-Proliferation of Weapons of Mass Destruction.