

## Description

The bipolar junction transistors (BJT) are designed to meet the stringent requirements of automotive applications.

## Features

- Ideally Suited for Automatic Insertion
- Complementary PNP Types: AC857BQ – AC857CQ – AC858BQ
- For Switching and AF Amplifier Applications
- **Totally Lead-Free & Fully RoHS Compliant (Notes 1 & 2)**
- **Halogen and Antimony Free. "Green" Device (Note 3)**
- **Qualified to AEC-Q101 Standards for High Reliability**
- **PPAP Capable (Note 4)**

## Mechanical Data

- Case: SOT23
- Case Material: Molded Plastic, "Green" Molding Compound  
UL Flammability Classification Rating 94V-0
- Moisture Sensitivity: Level 1 per J-STD-020
- Terminals: Finish—Matte Tin Plated Leads, Solderable per MIL-STD-202, Method 208 Ⓔ③
- Weight: 0.008 grams (Approximate)

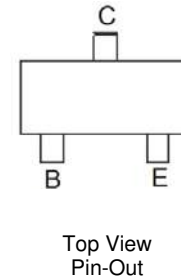
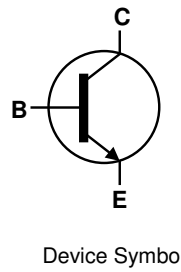

## Ordering Information (Notes 4 & 5)

Product	Compliance	Marking	Reel Size (inches)	Quantity per Reel
AC847BQ-7	Automotive	2D1	7	3000
AC847CQ-7	Automotive	2C9	7	3000
AC848BQ-7	Automotive	2K9	7	3000
AC848BQ-13	Automotive	2K9	13	10,000

- Notes:
1. No purposely added lead. Fully EU Directive 2002/95/EC (RoHS), 2011/65/EU (RoHS 2) & 2015/863/EU (RoHS 3) compliant
  2. See <https://www.diodes.com/quality/lead-free/> for more information about Diodes Incorporated's definitions of Halogen- and Antimony-free, "Green" and Lead-free.
  3. Halogen- and Antimony-free "Green" products are defined as those which contain <900ppm bromine, <900ppm chlorine (<1500ppm total Br + Cl) and <1000ppm antimony compounds.
  4. Automotive products are AEC-Q101 qualified and are PPAP capable. Refer to <https://www.diodes.com/quality/>.
  5. For packaging details, see <https://www.diodes.com/design/support/packaging/diodes-packaging/>.

## Marking Information

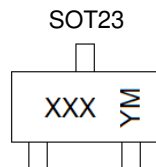

XXX = Product Type Marking Code  
 YM = Date Code Marking  
 Y or  $\bar{Y}$  = Year (ex: G = 2019)  
 M or  $\bar{M}$  = Month (ex: 9 = September)

### Date Code Key

Year	2017	2018	2019	2020	2021	2022	2023	2024	2025	2026	2027	2028
Code	E	F	G	H	I	J	K	L	M	N	O	P

Month	Jan	Feb	Mar	Apr	May	Jun	Jul	Aug	Sep	Oct	Nov	Dec
Code	1	2	3	4	5	6	7	8	9	O	N	D

**Absolute Maximum Ratings** (@T<sub>A</sub> = +25°C, unless otherwise specified.)

Characteristic		Symbol	Value	Unit
Collector-Base Voltage	AC847	V <sub>CBO</sub>	50	V
	AC848		30	
Collector-Emitter Voltage	AC847	V <sub>CEO</sub>	45	V
	AC848		30	
Emitter-Base Voltage	AC847	V <sub>EBO</sub>	6.0	V
	AC848		5.0	
Continuous Collector Current		I <sub>C</sub>	100	mA
Peak Collector Current		I <sub>CM</sub>	200	mA
Peak Emitter Current		I <sub>EM</sub>	200	mA

**Thermal Characteristics** (@T<sub>A</sub> = +25°C, unless otherwise specified.)

Characteristic		Symbol	Value	Unit
Power Dissipation	(Note 6)	P <sub>D</sub>	310	mW
	(Note 7)		350	
Thermal Resistance, Junction to Ambient	(Note 6)	R <sub>θJA</sub>	403	°C/W
	(Note 7)		357	
Thermal Resistance, Junction to Leads	(Note 8)	R <sub>θJL</sub>	350	°C/W
Operating and Storage Temperature Range		T <sub>J</sub> , T <sub>STG</sub>	-65 to +150	°C

**ESD Ratings** (Note 9)

Characteristic	Symbol	Value	Unit	JEDEC Class
Electrostatic Discharge—Human Body Model	ESD HBM	4000	V	3A
Electrostatic Discharge—Machine Model	ESD MM	400	V	C

- Notes:
6. For a device mounted on minimum recommended pad layout 1oz copper that is on a single-sided FR-4 PCB; device is measured under still air conditions whilst operating in a steady-state.
  7. Same as Note 6 except the device is mounted on 15mm × 15mm 1oz copper.
  8. Thermal resistance from junction to solder-point (at the end of the leads).
  9. Refer to JEDEC specification JESD22-A114 and JESD22-A115.

**Thermal Characteristics and Derating Information**

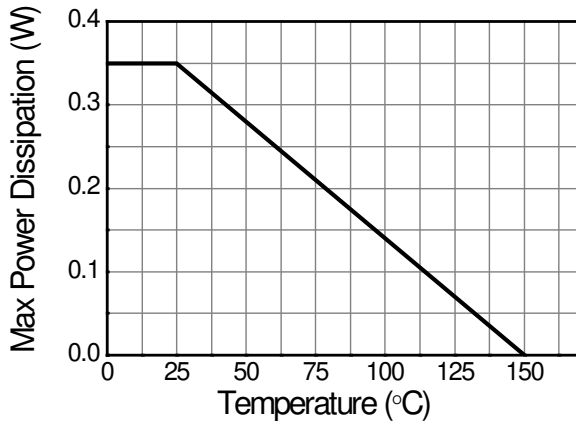

**Derating Curve**

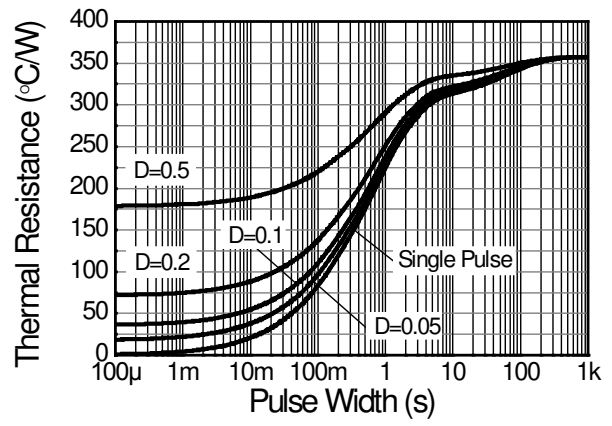

**Transient Thermal Impedance**

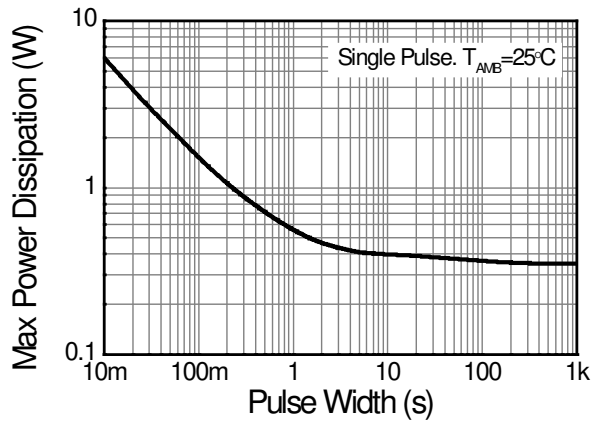

**Pulse Power Dissipation**

**Electrical Characteristics** (@T<sub>A</sub> = +25°C, unless otherwise specified.)

Characteristic		Symbol	Min	Typ	Max	Unit	Test Condition
Collector-Base Breakdown Voltage	AC847	BV <sub>CBO</sub>	50	—	—	V	I <sub>C</sub> = 10μA
	AC848		30	—	—	—	—
Collector-Emitter Breakdown Voltage (Note 10)	AC847	BV <sub>CEO</sub>	45	—	—	V	I <sub>C</sub> = 10mA
	AC848		30	—	—	—	—
Emitter-Base Breakdown Voltage	AC847	BV <sub>EBO</sub>	6	—	—	V	I <sub>E</sub> = 1μA
	AC848		5	—	—	—	—
Collector Cutoff Current		I <sub>CBO</sub>	—	—	15	nA	V <sub>CB</sub> = 30V
					5	μA	V <sub>CB</sub> = 30V, T <sub>J</sub> = +150°C
Collector Emitter Cutoff Current		I <sub>CES</sub>	—	—	15	nA	V <sub>CE</sub> = 50V
Emitter Base Cutoff Current		I <sub>EBO</sub>	—	—	100	nA	V <sub>EB</sub> = 5V
Small Signal Current Gain (Note 10)	AC847BQ/AC848BQ	h <sub>re</sub>	—	330	—	—	I <sub>C</sub> = 2.0mA, V <sub>CE</sub> = 5V f = 1.0kHz
	AC847CQ			600			
Input Impedance (Note 10)	AC847BQ/AC848BQ	h <sub>ie</sub>	—	4.5	—	kΩ	
	AC847CQ			8.7			
Output Admittance (Note 10)	AC847BQ/AC848BQ	h <sub>oe</sub>	—	30	—	μs	
	AC847CQ			60			
Reverse Voltage Transfer Ratio (Note 10)	AC847BQ/AC848BQ	h <sub>re</sub>	—	2x10 <sup>-4</sup>	—	—	
	AC847CQ			3x10 <sup>-4</sup>			
DC Current Gain (Note 10)	AC847BQ/AC848BQ	h <sub>FE</sub>	200	290	450	—	
	AC847CQ		420	520	800		
Collector-Emitter Saturation Voltage (Note 10)		V <sub>CE(SAT)</sub>	—	90	250	mV	I <sub>C</sub> = 10mA, I <sub>B</sub> = 0.5mA
				200	600	mV	I <sub>C</sub> = 100mA, I <sub>B</sub> = 5.0mA
Base-Emitter Turn-On Voltage (Note 10)		V <sub>BE(ON)</sub>	580	660	700	mV	I <sub>C</sub> = 2mA, V <sub>CE</sub> = 5V
				—	770		mV
Base-Emitter Saturation Voltage (Note 10)		V <sub>BE(SAT)</sub>	—	700	—	mV	I <sub>C</sub> = 10mA, I <sub>B</sub> = 0.5mA
				900			mV
Output Capacitance		C <sub>OBO</sub>	—	3	—	pF	V <sub>CB</sub> = 10V, f = 1.0MHz
Transition Frequency		f <sub>T</sub>	100	300	—	MHz	V <sub>CE</sub> = 5V, I <sub>C</sub> = 10mA, f = 100MHz
Noise Figure		NF	—	2	10	dB	V <sub>CE</sub> = 5V, I <sub>C</sub> = 200μA R <sub>S</sub> = 2kΩ, f = 1kHz Δf = 200Hz

Note: 10. Measured under pulsed conditions. Pulse width ≤ 300μs. Duty cycle ≤ 2%.

**Typical Electrical Characteristics** (@ $T_A = +25^\circ\text{C}$ , unless otherwise specified.)

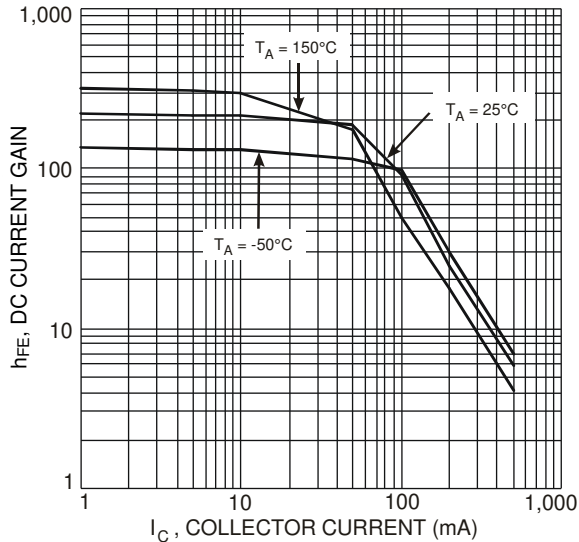

Figure 1 Typical DC Current Gain vs. Collector Current

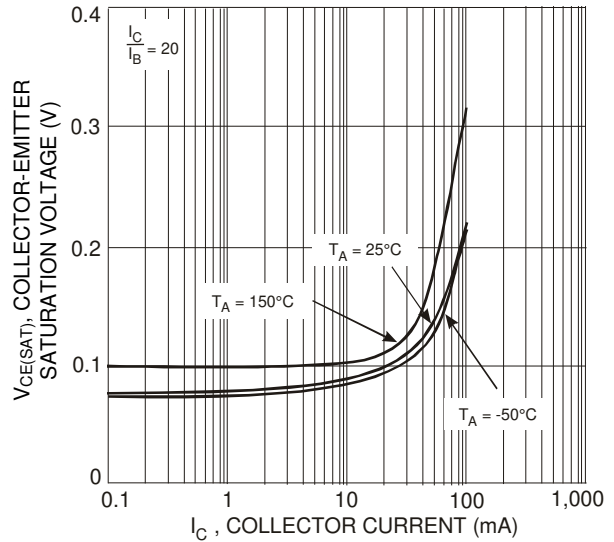

Figure 2 Typical Collector-Emitter Saturation Voltage vs. Collector Current

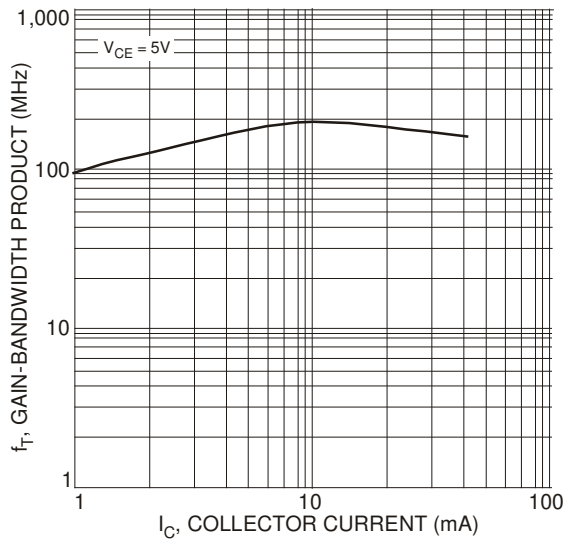

Figure 3 Typical Gain-Bandwidth Product vs. Collector Current

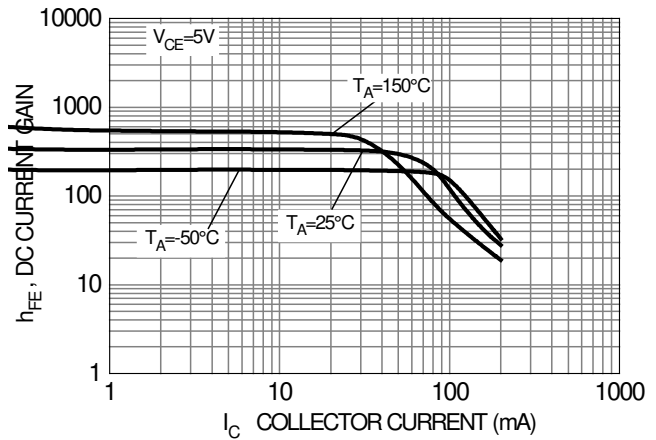

Figure 4 Typical DC Current Gain vs. Collector Current (Band B Group Gain)

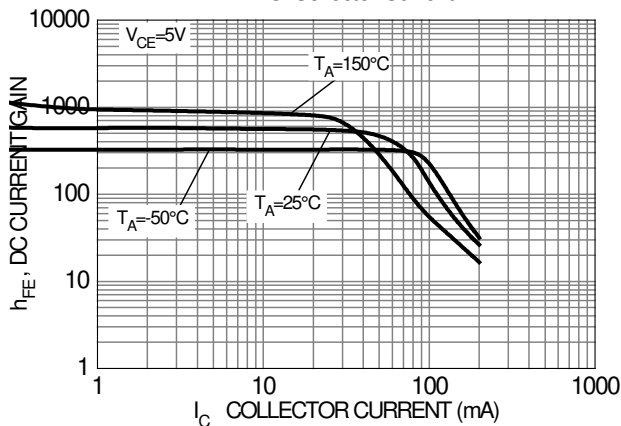
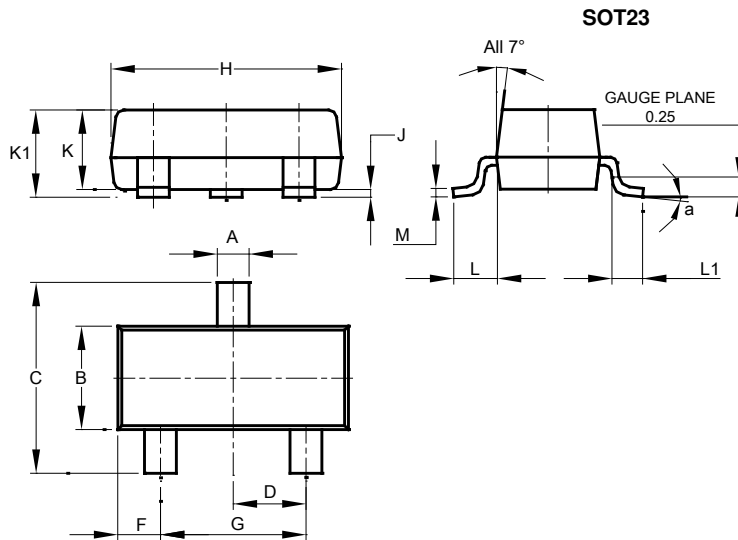

Figure 5 Typical DC Current Gain vs. Collector Current (Band C Group Gain)

**Package Outline Dimensions**

Please see <http://www.diodes.com/package-outlines.html> for the latest version.



SOT23			
Dim	Min	Max	Typ
A	0.37	0.51	0.40
B	1.20	1.40	1.30
C	2.30	2.50	2.40
D	0.89	1.03	0.915
F	0.45	0.60	0.535
G	1.78	2.05	1.83
H	2.80	3.00	2.90
J	0.013	0.10	0.05
K	0.890	1.00	0.975
K1	0.903	1.10	1.025
L	0.45	0.61	0.55
L1	0.25	0.55	0.40
M	0.085	0.150	0.110
a	0°	8°	--
All Dimensions in mm			

**Suggested Pad Layout**

Please see <http://www.diodes.com/package-outlines.html> for the latest version.

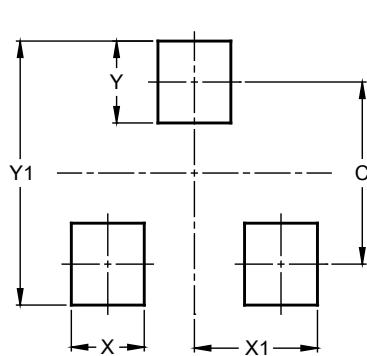

Dimensions	Value (in mm)
C	2.0
X	0.8
X1	1.35
Y	0.9
Y1	2.9

**IMPORTANT NOTICE**

DIODES INCORPORATED MAKES NO WARRANTY OF ANY KIND, EXPRESS OR IMPLIED, WITH REGARDS TO THIS DOCUMENT, INCLUDING, BUT NOT LIMITED TO, THE IMPLIED WARRANTIES OF MERCHANTABILITY AND FITNESS FOR A PARTICULAR PURPOSE (AND THEIR EQUIVALENTS UNDER THE LAWS OF ANY JURISDICTION).

Diodes Incorporated and its subsidiaries reserve the right to make modifications, enhancements, improvements, corrections or other changes without further notice to this document and any product described herein. Diodes Incorporated does not assume any liability arising out of the application or use of this document or any product described herein; neither does Diodes Incorporated convey any license under its patent or trademark rights, nor the rights of others. Any Customer or user of this document or products described herein in such applications shall assume all risks of such use and will agree to hold Diodes Incorporated and all the companies whose products are represented on Diodes Incorporated website, harmless against all damages.

Diodes Incorporated does not warrant or accept any liability whatsoever in respect of any products purchased through unauthorized sales channel. Should Customers purchase or use Diodes Incorporated products for any unintended or unauthorized application, Customers shall indemnify and hold Diodes Incorporated and its representatives harmless against all claims, damages, expenses, and attorney fees arising out of, directly or indirectly, any claim of personal injury or death associated with such unintended or unauthorized application.

Products described herein may be covered by one or more United States, international or foreign patents pending. Product names and markings noted herein may also be covered by one or more United States, international or foreign trademarks.

This document is written in English but may be translated into multiple languages for reference. Only the English version of this document is the final and determinative format released by Diodes Incorporated.

**LIFE SUPPORT**

Diodes Incorporated products are specifically not authorized for use as critical components in life support devices or systems without the express written approval of the Chief Executive Officer of Diodes Incorporated. As used herein:

A. Life support devices or systems are devices or systems which:

1. are intended to implant into the body, or
2. support or sustain life and whose failure to perform when properly used in accordance with instructions for use provided in the labeling can be reasonably expected to result in significant injury to the user.

B. A critical component is any component in a life support device or system whose failure to perform can be reasonably expected to cause the failure of the life support device or to affect its safety or effectiveness.

Customers represent that they have all necessary expertise in the safety and regulatory ramifications of their life support devices or systems, and acknowledge and agree that they are solely responsible for all legal, regulatory and safety-related requirements concerning their products and any use of Diodes Incorporated products in such safety-critical, life support devices or systems, notwithstanding any devices- or systems-related information or support that may be provided by Diodes Incorporated. Further, Customers must fully indemnify Diodes Incorporated and its representatives against any damages arising out of the use of Diodes Incorporated products in such safety-critical, life support devices or systems.

Copyright © 2019, Diodes Incorporated

[www.diodes.com](http://www.diodes.com)