

# 1-PORT 10GBASE-T SMD RJ45 WITH INTEGRATED MAGNETICS

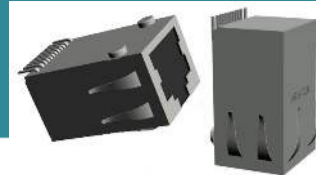

**ARJE-1034**

16.10 x 13.87 x 25.68mm  
RoHS/RoHS II Compliant

## FEATURES

- High speed 10GBase-T
- 10/100/1000Base-T compatibility
- Surface mount device
- Wide -40C to 85C operating temperature range
- Integrated magnetics
- Integrated shielding and metal fingers for excellent EMI performance

## APPLICATIONS

- Networking equipment
- Industrial IoT/IoT
- Video IP cameras
- Machine-to-machine (M2M)
- Industrial process control
- Servers and cloud computing
- High performance computing (HPC)
- Network interface cards (NIC)
- Media converters

## STANDARD SPECIFICATIONS

Parameters	Minimum	Typical	Maximum	Units	Notes
Turn Ratio ( $\pm 3\%$ )		1CT:1CT			
Inductance	100			$\mu\text{H}$	100kHz, 0.1Vrms
Insertion Loss			-3.0	dB	100KHz
			-2.0		1-400MHz
Return Loss	-18.0			dB	1-40MHz
	$19-10\text{Log}(F/40)^*$				40-500MHz
Crosstalk	-30.0			dB	1-100MHz
	-20.0				100-500MHz
CM-DMRR	-30.0			dB	1-250MHz
	-20.0				250-500MHz
Hipot		1500 Vrms min		Pri to Sec	
Operating Temperature	-40		85	C	See options

## PART NUMBER IDENTIFICATION

**ARJE-1034-**

Operating Temperature (See Table 1 for details)

Blank: -40°C ~ +85°C  
A: 0°C ~ +70°C

# 1-PORT 10GBASE-T SMD RJ45 WITH INTEGRATED MAGNETICS

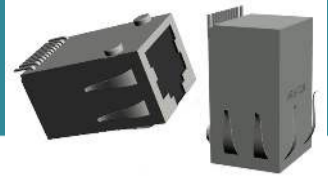

**ARJE-1034**

16.10 x 13.87 x 25.68mm  
RoHS/RoHS II Compliant

**MECHANICAL DIMENSIONS: mm (unless otherwise specific, all tolerances are  $\pm 0.01/0.25$ )**

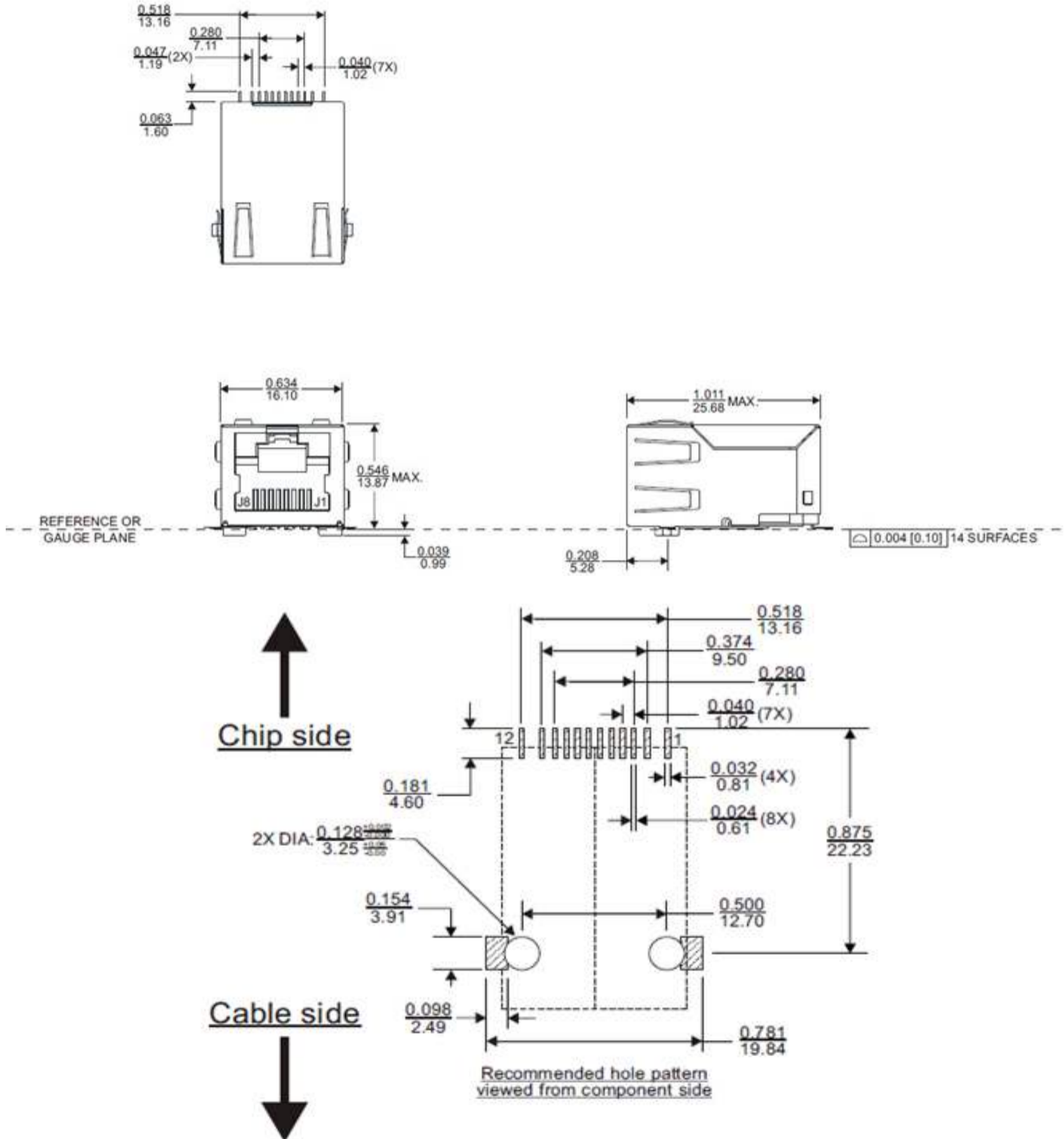

REVISED: 09/26/2016

# 1-PORT 10GBASE-T SMD RJ45 WITH INTEGRATED MAGNETICS

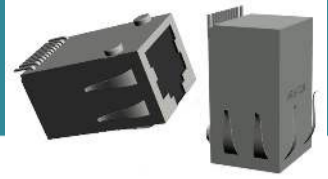

**ARJE-1034**

16.10 x 13.87 x 25.68mm  
RoHS/RoHS II Compliant

## SCHEMATIC

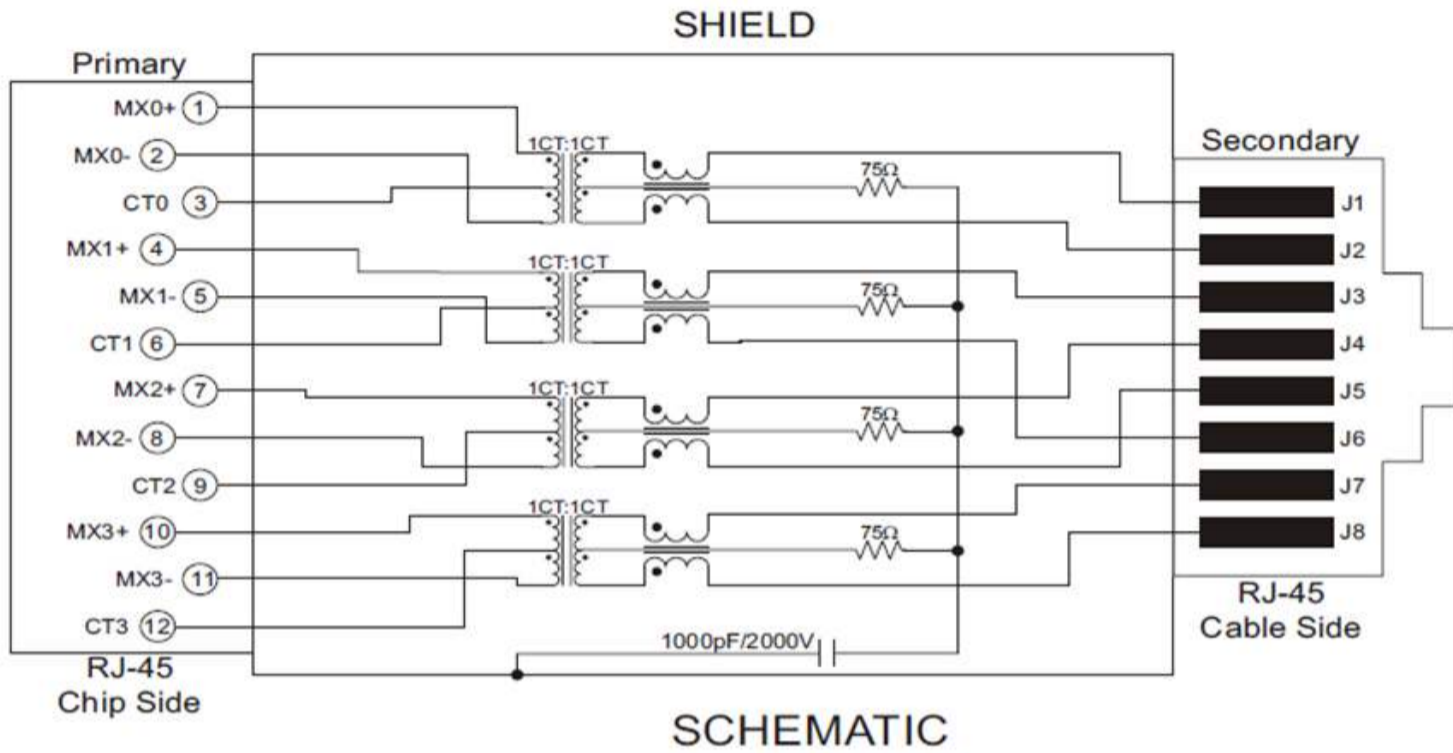

## REFLOW

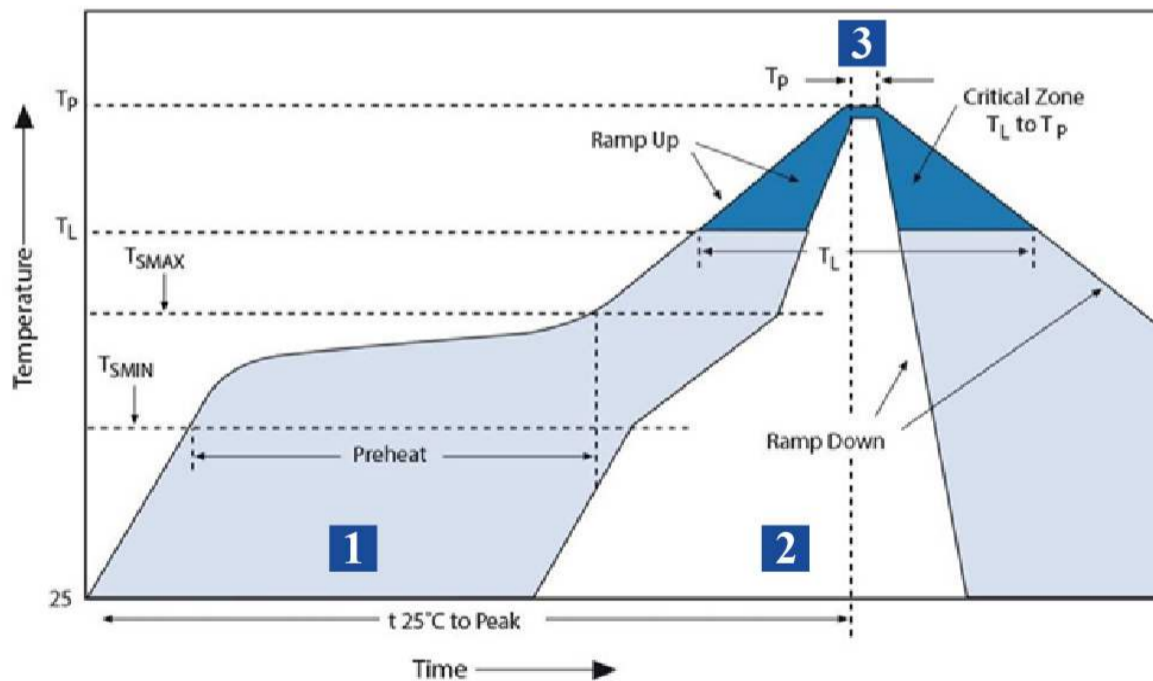

Zone	Description	Temperature	Time
1	Preheat	$T_{SMIN} \sim T_{SMAX}$ 150°C ~ 200°C	60 ~ 180 sec.
2	Reflow	$T_L$ 217°C	60 ~ 150 sec.
3	Peak heat	$T_p$ 245°C	20 ~ 40 sec.

REVISED: 09/26/2016

# 1-PORT 10GBASE-T SMD RJ45 WITH INTEGRATED MAGNETICS

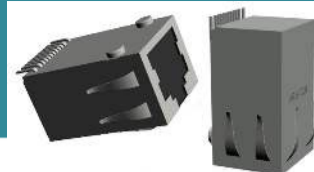

**ARJE-1034**

16.10 x 13.87 x 25.68mm  
RoHS/RoHS II Compliant

## PACKAGING

**T: 110 pcs/reel**

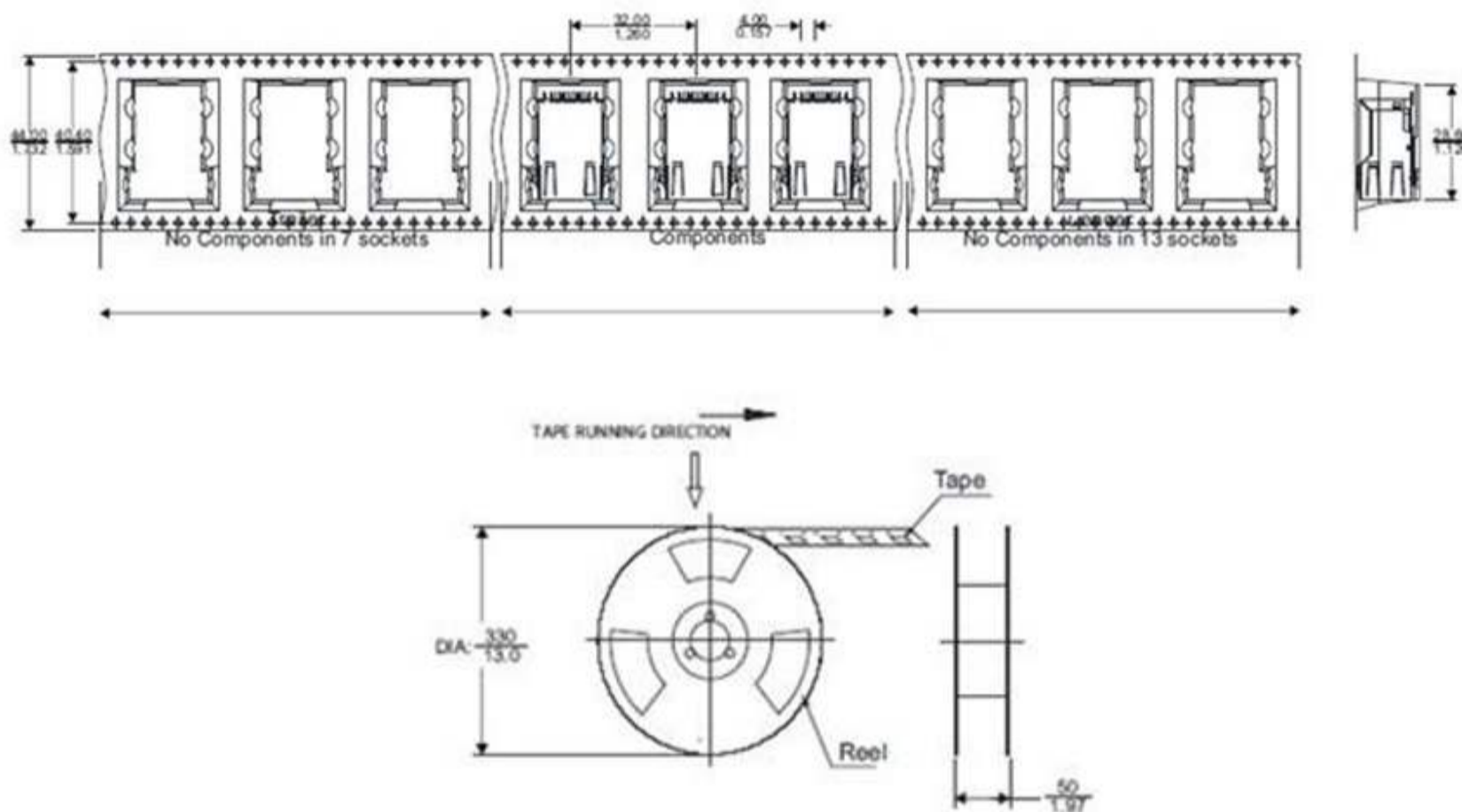

## NOTES

1. The parts are manufactured in accordance with this specification. If other conditions and specifications which are required for this specification, please contact ABRACON for more information.
2. ABRACON will supply the parts in accordance with this specification unless we receive a written request to modify prior to an order placement.
3. In no case shall ABRACON be liable for any product failure from in appropriate handling or operation of the item beyond the scope of this specification.
4. When changing your production process, please notify ABRACON immediately.
5. ABRACON LLC's products are COTS – Commercial-Off-The-Shelf products; suitable for Commercial, Industrial and, where designated, Automotive Applications. ABRACON's products are not specifically designed for Military, Aviation, Aerospace, Life- dependent Medical applications or any application requiring high reliability where component failure could result in loss of life and/or property. For applications requiring high reliability and/or presenting an extreme operating environment, written consent and authorization from ABRACON LLC is required. Please contact ABRACON LLC for more information.
6. All specifications and Marking will be subject to change without notice.

REVISED: 09/26/2016



5101 Hidden Creek Lane Spicewood TX 78669  
Phone: 512-371-6159 | Fax: 512-351-8858  
For terms and conditions of sale please visit:  
[www.abracon.com](http://www.abracon.com)

ABRACON IS  
ISO9001-2008  
CERTIFIED