

Aximax, 400 Series, Axial, Conformally Coated, Ultra-Stable X8R Dielectric, 50 – 200 VDC (Commercial & Automotive Grade)

Overview

KEMET's Aximax conformally coated axial through-hole ceramic capacitors in Ultra-Stable X8R dielectric feature a 150°C maximum operating temperature, offering the latest in high temperature dielectric technology and reliability for extreme temperature applications. It offers the same temperature capability as conventional X8R, but without the capacitance loss due to applied DC voltage. Ultra-Stable X8R exhibits no change in capacitance with respect to voltage and boasts a minimal change in capacitance with reference to ambient temperature. It is a suitable replacement for higher capacitance and larger footprint devices that fail to offer capacitance stability. Capacitance change with respect to temperature is limited to $\pm 15\%$ from -55°C to 150°C .

Driven by the demand for a more robust and reliable component, the Ultra-Stable X8R dielectric Aximax through-hole capacitors were developed for critical applications where reliability and capacitance stability at higher operating temperatures are a concern. These capacitors are widely used in automotive circuits as well as general high temperature applications.

In addition to Commercial Grade, Automotive Grade devices are available and meet the demanding Automotive Electronics Council's AEC-Q200 qualification requirements.

These devices meet the flame test requirements outlined in UL Standard 94V-0.



Ordering Information

C	410	C	472	J	5	H	5	T	A	7200
Ceramic	Style/Size	Specification/Series	Capacitance Code (pF)	Capacitance Tolerance ¹	Rated Voltage (VDC)	Dielectric	Design	Lead Finish ²	Failure Rate	Packaging/Grade (C-Spec)
	410 430	C = Standard	Two significant digits and number of zeros	D = ± 0.5 pF F = $\pm 1\%$ G = $\pm 2\%$ J = $\pm 5\%$ K = $\pm 10\%$ M = $\pm 20\%$	5 = 50 1 = 100 2 = 200	H = Ultra-Stable X8R	5 = Multilayer	T = 100% Matte Sn H = SnPb (60/40)*	A = N/A	Blank = Bulk 7200 = 12" reel 7293 = Ammo pack 9170 = Automotive grade 9170 7200 = Auto 12" reel 9170 7293 = Auto ammo pack

¹ Additional capacitance Tolerance offerings may be available. Contact KEMET for details.

² Lead wire materials:

Standard: 100% matte tin (Sn) with nickel (Ni) underplate and steel core ("T" designation).

Alternative 1: 60% tin (Sn)/40% lead (Pb) finish with copper-clad steel core ("H" designation). KEMET does not recommend the usage of this termination for Automotive applications.

Additional lead finish options may be available. Contact KEMET for details.

* Only available as Commercial Grade.

Automotive C-Spec Information

KEMET Automotive Grade products meet or exceed the requirements outlined by the Automotive Electronics Council. The details regarding test methods and conditions are referenced in the document AEC-Q200, Stress Test Qualification for Passive Components. These products are supported by a Product Change Notification (PCN) and Production Part Approval Process warrant (PPAP).

Automotive products offered through our distribution channel have been assigned an inclusive ordering code C-Spec, “9170.” This C-Spec was developed in order to better serve small and medium-sized companies that prefer an automotive grade component, without the requirement to submit a customer Source Controlled Drawing (SCD) or specification for review by a KEMET engineering specialist. This C-Spec is therefore not intended for use by KEMET’s OEM Automotive customers and are not granted the same “privileges” as other automotive C-Specs. Customer PCN approval and PPAP request levels are limited (see details below).

Product Change Notification (PCN)

The KEMET Product Change Notification system is used to communicate primarily the following types of changes:

- Product/process changes that affect product form, fit, function, and/or reliability
- Changes in manufacturing site
- Product obsolescence

KEMET Automotive C-Spec	Customer Notification due to:		Days prior to implementation
	Process/Product change	Obsolescence*	
KEMET assigned ¹	Yes (with approval and sign off)	Yes	180 days Minimum
9170	Yes (without approval)	Yes	90 days Minimum

¹ KEMET assigned C-Specs require the submittal of a customer SCD or customer specification for review. For additional information contact KEMET.

Production Part Approval Process (PPAP)

The purpose of the Production Part Approval Process is:

- To ensure that supplier can meet the manufacturability and quality requirements for the purchased parts.
- To provide the evidence that all customer engineering design record and specification requirements are properly understood and fulfilled by the manufacturing organization.
- To demonstrate that the established manufacturing process has the potential to produce the part

KEMET Automotive C-Spec	PPAP (Product Part Approval Process) Level				
	1	2	3	4	5
KEMET assigned ¹	●	●	●	●	●
9170			○		

¹ KEMET assigned C-Specs require the submittal of a customer SCD or customer specification for review. For additional information contact KEMET.

- Part Number specific PPAP available
- Product family PPAP only

Dimensions – Inches (Millimeters)

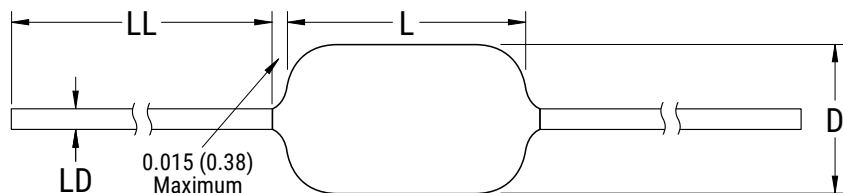

Series	Style/ Size	L Length Maximum	D Diameter Maximum	LD Lead Diameter	LL Lead Length Minimum ¹
C41X	410	0.170 (4.32)	0.095 (2.41)	0.020+0.001/-0.003 (0.51+0.025/-0.076)	1.0 (25.4)
C43X	430	0.240 (6.10)	0.150 (3.81)		

¹ Lead Length dimension only applicable for BULK packaging.

Benefits

- Axial through-hole form factor
- Conformally coated
- Operating temperature range of -55°C to +150°C
- Lead (Pb)-free, RoHS and REACH compliant
- DC voltage ratings of 50 V, 100 V and 200 V
- Capacitance offerings ranging from 1 pF up to 0.082 μF
- Available capacitance tolerances of ±0.5pF, ±1%, ±2%, ±5%, ±10%, and ±20%
- Extremely low ESR and ESL
- High thermal stability
- High ripple current capability
- No capacitance change with respect to applied rated DC voltage
- Negligible capacitance change with respect to temperature from -55°C to +150°C
- No capacitance decay with time
- Non-polar device, minimizing installation concerns
- 100% pure matte tin-plated lead finish allowing for excellent solderability
- SnPb-plated lead finish option available upon request (60/40)
- Encapsulation meets flammability standard UL 94V-0

Applications

Typical applications include decoupling, bypass and filtering in extreme environments such as down-hole oil exploration, under-hood automotive, aerospace and defense.

Application Notes

These devices are not recommended for use in overmold applications and/or processes.

Qualification/Certification

Commercial Grade products are subject to internal qualification. Details regarding test methods and conditions are referenced in Table 4, Performance & Reliability.

Automotive Grade products meet or exceed the requirements outlined by the Automotive Electronics Council. Details regarding test methods and conditions are referenced in document AEC-Q200, Stress Test Qualification for Passive Components. For additional information regarding the Automotive Electronics Council and AEC-Q200, please visit their website at www.aecouncil.com.

Environmental Compliance

Lead (Pb)-free, RoHS, and REACH compliant without exemptions (excluding SnPb termination finish option).

Electrical Parameters/Characteristics

Item	Parameters/Characteristics
Operating Temperature Range	-55°C to +150°C
Capacitance Change with Reference to +25°C and 0 VDC Applied (TCC)	±15%
Aging Rate (Maximum % Capacitance Loss/Decade Hour)	0%
Dielectric Withstanding Voltage (DWV)	250% of rated voltage (5±1 seconds and charge/discharge not exceeding 50 mA)
Dissipation Factor (DF) Maximum Limit at 25°C	2.5%
Insulation Resistance (IR) Limit at 25°C	1,000 megohm microfarads or 100 GΩ (Rated voltage applied for 120±5 seconds at 25°C)

To obtain IR limit, divide MQ-μF value by the capacitance and compare to GΩ limit. Select the lower of the two limits.

Capacitance and dissipation factor (DF) measured under the following conditions:

1 MHz ±100 kHz and 1.0 ±0.2 Vrms if capacitance ≤ 1,000 pF

1 kHz ±50 Hz and 1.0 ±0.2 Vrms if capacitance > 1,000 pF

Note: When measuring capacitance it is important to ensure the set voltage level is held constant. The HP4284 and Agilent E4980 have a feature known as Automatic Level Control (ALC). The ALC feature should be switched to "ON."

Post Environmental Limits

High Temperature Life, Biased Humidity, Moisture Resistance					
Dielectric	Rated DC Voltage	Capacitance Value	Dissipation Factor (Maximum %)	Capacitance Shift	Insulation Resistance
Ultra-Stable X8R	All	All	3.0	0.3% or ±0.25 pF	10% of Initial Limit

Table 1A - C410 Style/Size (0.095" Diameter x 0.170" L), Capacitance Range Waterfall

C410 Style/Size (0.095" Diameter x 0.170" L)				
Rated Voltage (VDC)		50	100	200
Voltage Code		5	1	2
Capacitance	Capacitance Tolerance	Capacitance Code (Available Capacitance)		
1pF	D = ±0.5pF	109	109	109
1.1pF		119	119	119
1.2pF		129	129	129
1.3pF		139	139	139
1.5pF		159	159	159
1.6pF		169	169	169
1.8pF		189	189	189
2.0pF		209	209	209
2.2pF		229	229	229
2.4pF		249	249	249
2.7pF		279	279	279
3.0pF		309	309	309
3.3pF		339	339	339
3.6pF		369	369	369
3.9pF		399	399	399
4.3pF		439	439	439
4.7pF		479	479	479
5.1pF		519	519	519
5.6pF		569	569	569
6.2pF		629	629	629
6.8pF	689	689	689	
7.5pF	759	759	759	
8.2pF	829	829	829	
9.1pF	919	919	919	
10pF	F = ±1% G = ±2% J = ±5% K = ±10%	100	100	100
11pF		110	110	110
12pF		120	120	120
13pF		130	130	130
15pF		150	150	150
16pF		160	160	160
18pF		180	180	180
20pF		200	200	200
22pF		220	220	220
24pF		240	240	240
27pF		270	270	270
30pF		300	300	300
33pF		330	330	330
36pF		360	360	360
39pF		390	390	390
43pF		430	430	430
47pF		470	470	470
51pF		510	510	510
56pF		560	560	560
62pF		620	620	620
68pF	680	680	680	
75pF	750	750	750	
82pF	820	820	820	
91pF	910	910	910	
100pF	101	101	101	
120pF	121	121	121	
150pF	151	151	151	
180pF	181	181	181	
220pF	221	221	221	
270pF	271	271	271	
Rated Voltage (VDC)		50	100	200
Voltage Code		5	1	2

These products are protected under one or more of the following United States Patents and their non-U.S. counterparts: U.S. Pat. No. 7172985; U.S. Pat. No. 7670981.

Table 1A - C410 Style/Size (0.095" Diameter x 0.170" L), Capacitance Range Waterfall cont.

C410 Style/Size (0.095" Diameter x 0.170" L)				
Rated Voltage (VDC)		50	100	200
Voltage Code		5	1	2
Capacitance	Capacitance Tolerance	Capacitance Code (Available Capacitance)		
330pF	F = ±1% G = ±2% J = ±5% K = ±10%	331	331	331
390pF		391	391	391
470pF		471	471	471
560pF		561	561	561
680pF		681	681	681
820pF		821	821	821
1000pF		102	102	102
1100pF		112	112	
1200pF		122	122	
1500pF		152	152	
1800pF		182	182	
2200pF		222	222	
2700pF		272	272	
3300pF		332	332	
3900pF		392	392	
4700pF		472	472	
5100pF		512	512	
5600pF		562	562	
6200pF		622	622	
6800pF		682	682	
7500pF		752	752	
8200pF		822	822	
9100pF		912	912	
0.01μF		103	103	
0.012μF		123	123	
0.015μF		153	153	
0.018μF		183		
0.022μF	223			
Rated Voltage (VDC)		50	100	200
Voltage Code		5	1	2

These products are protected under one or more of the following United States Patents and their non-U.S. counterparts: U.S. Pat. No. 7172985; U.S. Pat. No. 7670981.

Table 1B - C430 Style/Size (0.150" Diameter x 0.290" L), Capacitance Range Waterfall

C430 Style/Size (0.150" Dia x 0.290" L)				
Rated Voltage (VDC)		50	100	200
Voltage Code		5	1	2
Capacitance	Capacitance Tolerance	Capacitance Code (Available Capacitance)		
100pF		101	101	101
110pF		111	111	111
120pF		121	121	121
130pF		131	131	131
150pF		151	151	151
160pF		161	161	161
180pF		181	181	181
200pF		201	201	201
220pF		221	221	221
240pF		241	241	241
270pF		271	271	271
300pF		301	301	301
330pF		331	331	331
360pF		361	361	361
390pF		391	391	391
430pF		431	431	431
470pF		471	471	471
510pF		511	511	511
560pF		561	561	561
620pF		621	621	621
680pF		681	681	681
750pF		751	751	751
820pF		821	821	821
910pF		911	911	911
1100pF		112	112	112
1200pF		122	122	122
1500pF		152	152	152
1800pF		182	182	182
2200pF		222	222	222
2700pF		272	272	272
3300pF		332	332	
3900pF		392	392	
4700pF		472	472	
5100pF		512	512	
5600pF		562	562	
6200pF		622	622	
6800pF		682	682	
7500pF		752	752	
8200pF		822	822	
9100pF		912	912	
0.01μF		103	103	
0.012μF		123	123	
0.015μF		153	153	
0.018μF		183	183	
0.022μF		223	223	
0.027μF		273	273	
0.033μF		333	333	
0.039μF		393	393	
0.047μF		473	473	
0.056μF		563		
0.068μF		683		
0.082μF		823		
	F = ±1%			
	G = ±2%			
	J = ±5%			
	K = ±10%			
Rated Voltage (VDC)		50	100	200
Voltage Code		5	1	2

These products are protected under one or more of the following United States Patents and their non-U.S. counterparts: U.S. Pat. No. 7172985; U.S. Pat. No. 7670981.

Soldering Process

Recommended Soldering Technique:

- Solder Wave
- Hand Soldering (Manual)

Recommended Soldering Profile:

- Optimum Wave Solder Profile

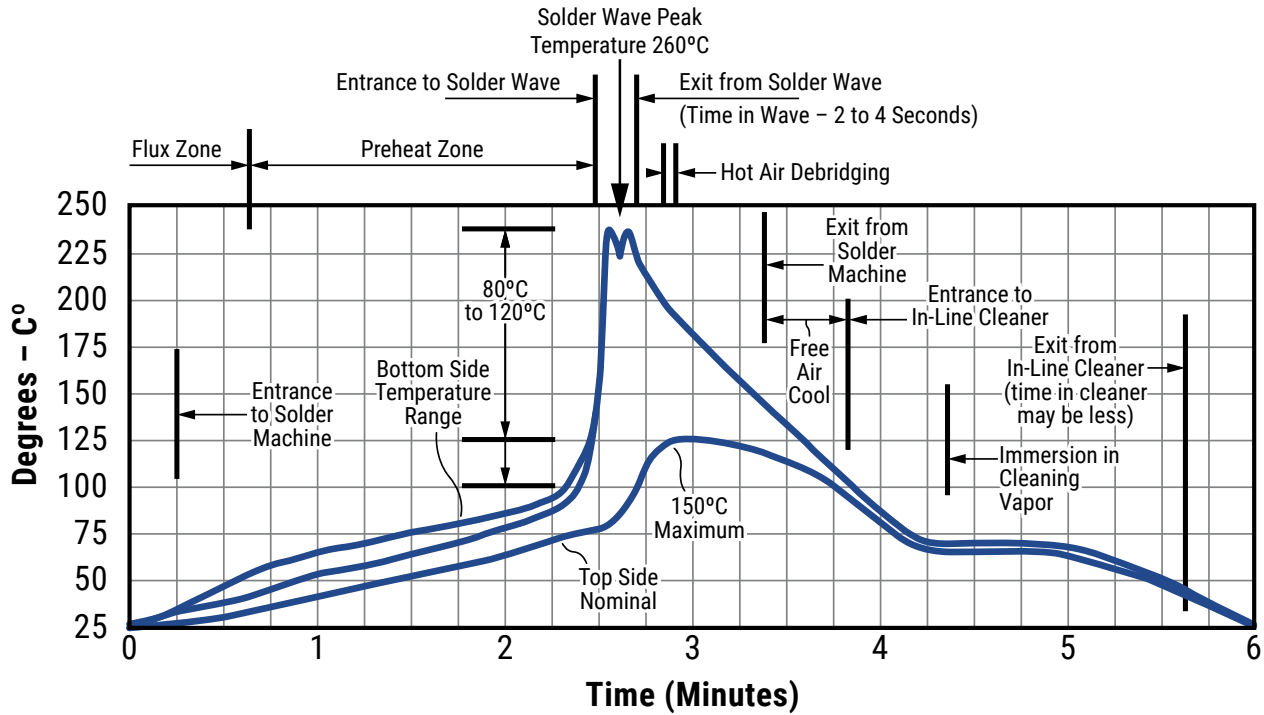

- Hand Soldering (Manual)

Manual Solder Profile with Pre-heating

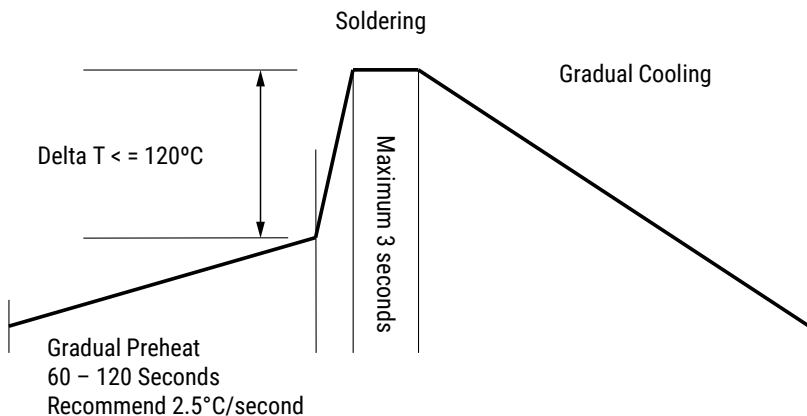

KEMET recommends following the guidelines and techniques outlined in technical bulletins F2103 and F9207.

Table 2 – Performance & Reliability: Test Methods and Conditions

Stress	Reference	Test or Inspection Method
Solderability	J-STD-002	Magnification 50 X. Conditions:
		a) Method A, at 235°C, Category 3
Temperature Cycling	JESD22 Method JA-104	5 cycles (-55°C to +150°C), measurement at 24 hours ±2 hours after test conclusion.
Biased Humidity	MIL-STD-202 Method 103	Load humidity: 1,000 hours 85°C/85% RH and rated voltage. Add 100 K ohm resistor. Measurement at 24 hours ±2 hours after test conclusion.
		Low volt humidity: 1,000 hours 85°C/85% RH and 1.5 V. Add 100 K ohm resistor. Measurement at 24 hours ±2 hours after test conclusion.
Moisture Resistance	MIL-STD-202 Method 106	t = 24 hours/cycle. Steps 7a and 7b not required. Unpowered. Measurement at 24 hours ±2 hours after test conclusion.
Thermal Shock	MIL-STD-202 Method 107	-55°C/+150°C. Note: Number of cycles required = 300. Maximum transfer time = 20 seconds. Dwell time – 15 minutes. Air – Air.
High Temperature Life	MIL-STD-202 Method 108/EIA-198	1,000 hours at 150°C with 2 X rated voltage applied.
Storage Life	MIL-STD-202 Method 108	150°C, 0 VDC, for 1,000 hours.
Vibration	MIL-STD-202 Method 204	5 g for 20 minutes, 12 cycles each of 3 orientations. Note: Use 8"X5" PCB .031" thick 7 secure points on one long side and 2 secure points at corners of opposite sides. Parts mounted within 2" from any secure point. Test from 10 – 2,000 Hz.
Resistance to Soldering Heat	MIL-STD-202 Method 210	Condition B. No preheat of samples. Note: single wave solder – procedure 2.
Terminal Strength	MIL-STD-202 Method 211	Conditions A (454g), Condition C (227g)
Mechanical Shock	MIL-STD-202 Method 213	Figure 1 of Method 213, Condition C.
Resistance to Solvents	MIL-STD-202 Method 215	Add aqueous wash chemical – OKEM Clean or equivalent.

Storage & Handling

The un-mounted storage life of a through-hole (leaded) ceramic capacitor is dependent upon storage and atmospheric conditions as well as packaging materials. While the ceramic chips enveloped under the epoxy coating themselves are quite robust in most environments, solderability of the wire lead on the final epoxy-coated product will be degraded by exposure to high temperatures, high humidity, corrosive atmospheres, and long term storage. In addition, packaging materials will be degraded by high temperature and exposure to direct sunlight – reels may soften or warp, and tape peel force may increase.

KEMET recommends storing the un-mounted capacitors in their original packaging, in a location away from direct sunlight, and where the temperature and relative humidity do not exceed 40 degrees centigrade and 70% respectively. For optimum solderability, capacitor stock should be used promptly, preferably within 18 months of receipt. For applications requiring pre-tinning of components, storage life may be extended if solderability is verified. Before cleaning, bonding or molding these devices, it is important to verify that your process does not affect product quality and performance. KEMET recommends testing and evaluating the performance of a cleaned, bonded or molded product prior to implementing and/or qualifying any of these processes.

Construction

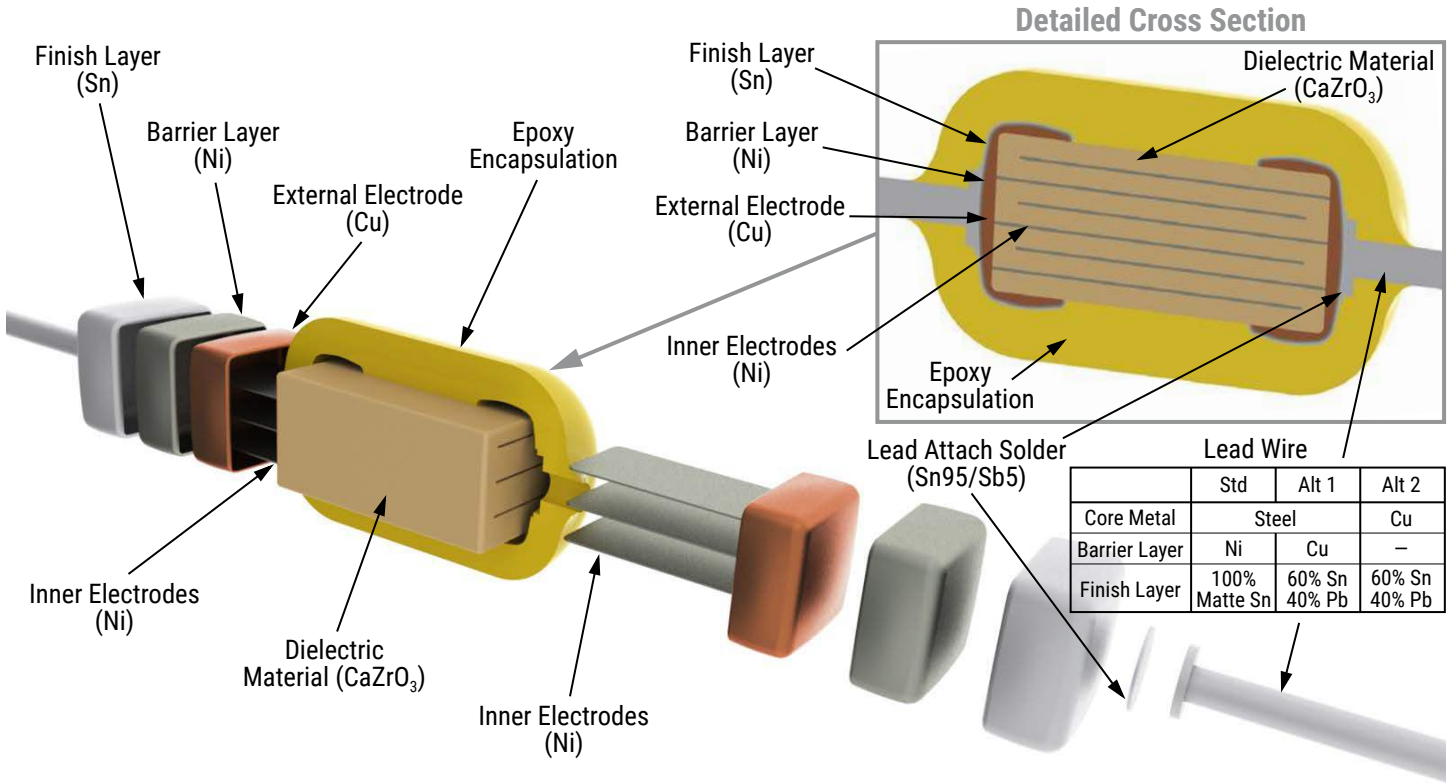

Marking

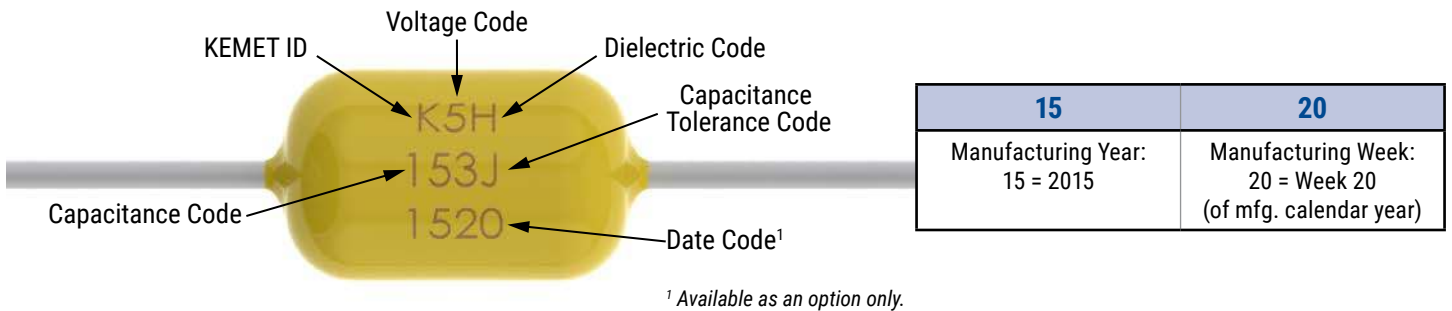

Packaging Quantities

Style/Size	Standard Bulk Quantity	Ammo Pack Quantity Maximum	Reel Quantity Maximum (12" Reel)
410	300/Box	4,000	5,000
430	200/Box	2,000	2,500

Tape & Reel Packaging Information

KEMET offers standard reeling of molded and conformally coated axial leaded ceramic capacitors for automatic insertion or lead forming machines in accordance with EIA standard 296. KEMET’s internal specification four-digit suffix, 7200, is placed at the end of the part number to designate tape and reel packaging, e.g., C410C104Z5U5TA7200.

Paper (50 lb.) test minimum is inserted between the layers of capacitors wound on reels for component pitch $\leq 0.400"$. Capacitor lead length may extend only a maximum of $.0625"$ (1.59 mm) beyond the tapes’ edges. Capacitors are centered in a row between the two tapes and will deviate only $\pm 0.031"$ (0.79 mm) from the row center. A minimum of $36"$ (91.5 cm) leader tape is provided at each finished length of taped components. Universal splicing clips are used to connect the tape.

Figure 1

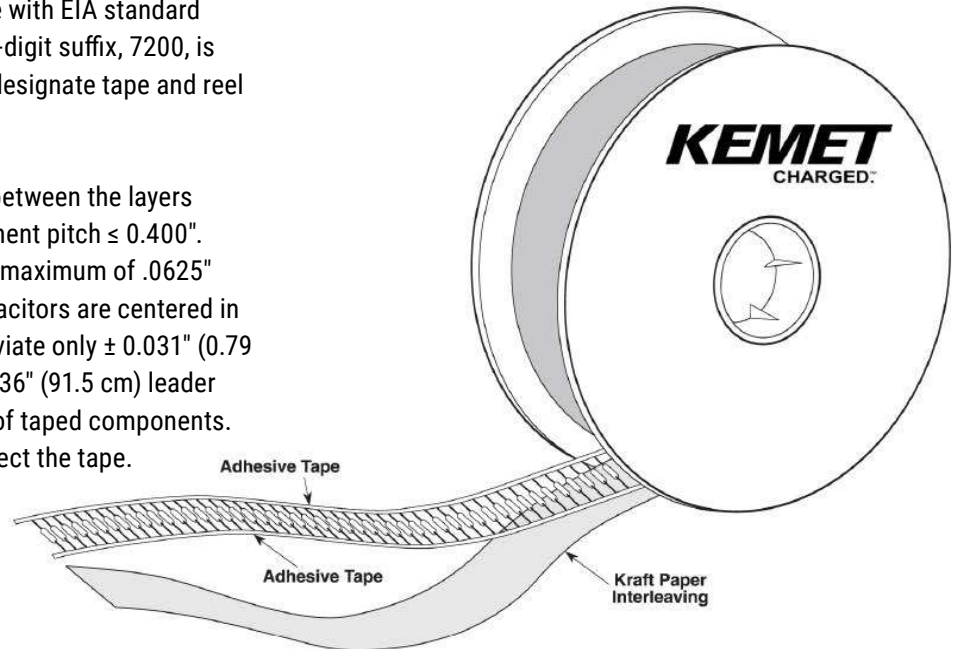

Figure 2

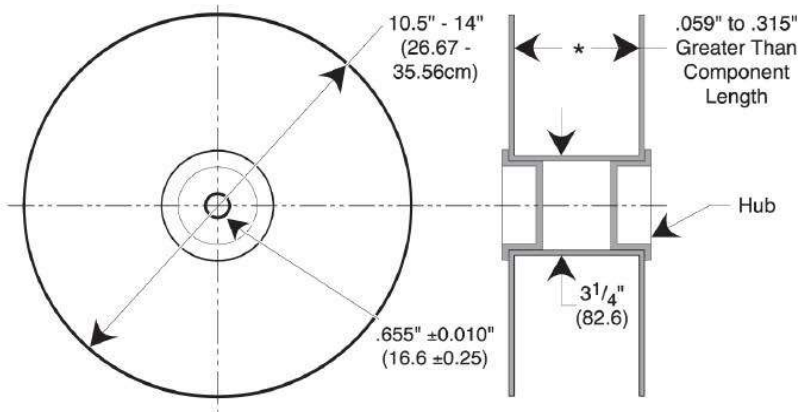

Figure 3

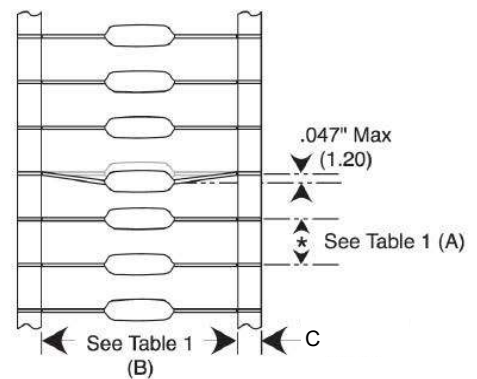

Table 3 – Ceramic Axial Tape and Reel Dimensions

Metric will govern

Dimensions – Millimeters (Inches)			
Axial Capacitor Body Diameter	A	B	C
	± 0.5 (0.020)	± 1.5 (0.059) ¹	± 0.70 (0.028)
0.0 to 5.0 (0.0 to 0.197)	5.0 (0.197)	52.4 (2.062)	6.35 (0.250)

Symbol Reference Table	
A	Component Pitch
B	Inside Tape Spacing
C	Tape Width

¹ Inside tape spacing dimension (B) is determined by the body diameter of the capacitor.

KEMET Electronics Corporation Sales Offices

For a complete list of our global sales offices, please visit www.kemet.com/sales.

Disclaimer

All product specifications, statements, information and data (collectively, the "Information") in this datasheet are subject to change. The customer is responsible for checking and verifying the extent to which the Information contained in this publication is applicable to an order at the time the order is placed. All Information given herein is believed to be accurate and reliable, but it is presented without guarantee, warranty, or responsibility of any kind, expressed or implied.

Statements of suitability for certain applications are based on KEMET Electronics Corporation's ("KEMET") knowledge of typical operating conditions for such applications, but are not intended to constitute – and KEMET specifically disclaims – any warranty concerning suitability for a specific customer application or use. The Information is intended for use only by customers who have the requisite experience and capability to determine the correct products for their application. Any technical advice inferred from this Information or otherwise provided by KEMET with reference to the use of KEMET's products is given gratis, and KEMET assumes no obligation or liability for the advice given or results obtained.

Although KEMET designs and manufactures its products to the most stringent quality and safety standards, given the current state of the art, isolated component failures may still occur. Accordingly, customer applications which require a high degree of reliability or safety should employ suitable designs or other safeguards (such as installation of protective circuitry or redundancies) in order to ensure that the failure of an electrical component does not result in a risk of personal injury or property damage.

Although all product-related warnings, cautions and notes must be observed, the customer should not assume that all safety measures are indicated or that other measures may not be required.

KEMET is a registered trademark of KEMET Electronics Corporation.