

Features

- High current capability
- High frequency operation up to 50 KHz
- Very soft ultra fast recovery antiparallel diode

Description

This IGBT utilizes the advanced Power MESH™ process resulting in an excellent trade-off between switching performance and low on-state behavior.

Applications

- High frequency inverters, UPS
- Motor drive
- SMPS and PFC in both hard switch and resonant topologies

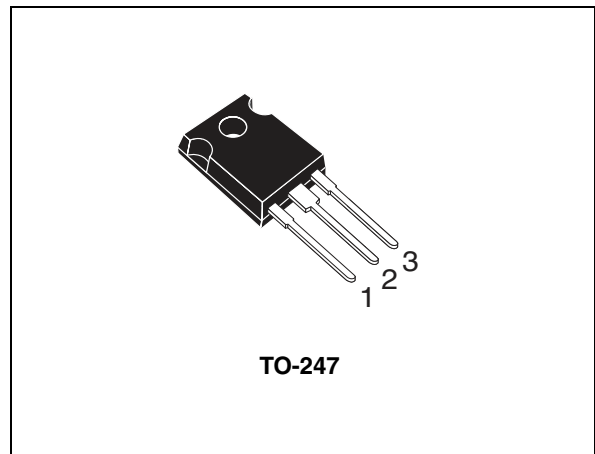

Figure 1. Internal schematic diagram

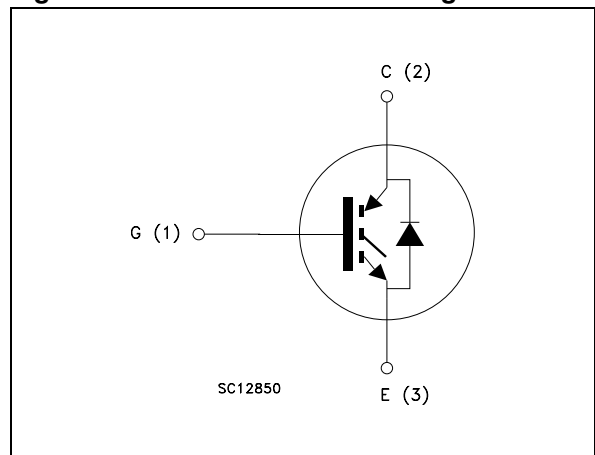

Table 1. Device summary

Order code	Marking	Package	Packaging
STGW20NC60VD	GW20NC60VD	TO-247	Tube

Contents

1	Electrical ratings	3
2	Electrical characteristics	4
2.1	Electrical characteristics (curves)	7
3	Test circuits	10
4	Package mechanical data	11
5	Revision history	13

1 Electrical ratings

Table 2. Absolute maximum ratings

Symbol	Parameter	Value	Unit
V_{CES}	Collector-emitter voltage ($V_{GE} = 0$)	600	V
$I_C^{(1)}$	Continuous collector current at $T_C = 25^\circ\text{C}$	60	A
$I_C^{(1)}$	Continuous collector current at $T_C = 100^\circ\text{C}$	30	A
$I_{CP}^{(2)}$	Pulsed collector current	150	A
$I_{CL}^{(3)}$	Turn-off latching current	100	A
V_{GE}	Gate-emitter voltage	± 20	V
I_F	Diode RMS forward current at $T_C = 25^\circ\text{C}$	30	A
I_{FSM}	Surge not repetitive forward current $t_p = 10$ ms sinusoidal	120	A
P_{TOT}	Total dissipation at $T_C = 25^\circ\text{C}$	200	W
T_j	Operating junction temperature	- 55 to 150	$^\circ\text{C}$
T_{stg}	Storage temperature		

1. Calculated according to the iterative formula:

$$I_C(T_C) = \frac{T_{j(\max)} - T_C}{R_{thj-c} \times V_{CE(sat)(\max)}(T_{j(\max)}, I_C(T_C))}$$

2. Pulse width limited by maximum junction temperature and turn-off within RBSOA.
 3. $V_{clamp} = 80\% V_{CES}$, $T_J = 150^\circ\text{C}$, $R_G = 10\ \Omega$, $V_{GE} = 15\ \text{V}$.

Table 3. Thermal data

Symbol	Parameter	Value	Unit
$R_{thj-case}$	Thermal resistance junction-case IGBT	0.63	$^\circ\text{C}/\text{W}$
	Thermal resistance junction-case diode	1.5	$^\circ\text{C}/\text{W}$
$R_{thj-amb}$	Thermal resistance junction-ambient	50	$^\circ\text{C}/\text{W}$

2 Electrical characteristics

($T_j = 25^\circ\text{C}$ unless otherwise specified)

Table 4. Static

Symbol	Parameter	Test conditions	Min.	Typ.	Max.	Unit
$V_{(BR)CES}$	Collector-emitter breakdown voltage ($V_{GE} = 0$)	$I_C = 1 \text{ mA}$	600			V
$V_{CE(sat)}$	Collector-emitter saturation voltage	$V_{GE}=15 \text{ V}, I_C=20 \text{ A}$ $V_{GE}=15 \text{ V}, I_C=20 \text{ A}, T_j=125^\circ\text{C}$		1.8 1.7	2.5	V V
$V_{GE(th)}$	Gate threshold voltage	$V_{CE}= V_{GE}, I_C= 250 \mu\text{A}$	3.75		5.75	V
I_{CES}	Collector-cut-off current ($V_{GE} = 0$)	$V_{CE} = 600 \text{ V}$ $V_{CE}=600 \text{ V}, T_j= 125^\circ\text{C}$			250 1	μA mA
I_{GES}	Gate-emitter leakage current ($V_{CE} = 0$)	$V_{GE} = \pm 20\text{V}$			± 100	nA
g_{fs}	Forward transconductance	$V_{CE} = 15 \text{ V}, I_C= 20 \text{ A}$		15		S

Table 5. Dynamic

Symbol	Parameter	Test conditions	Min.	Typ.	Max	Unit
C_{ies}	Input capacitance	$V_{CE} = 25\text{V}, f = 1 \text{ MHz}, V_{GE}= 0$	-	2200		pF
C_{oes}	Output capacitance			225		pF
C_{res}	Reverse transfer capacitance			50		pF
Q_g	Total gate charge	$V_{CE} = 390\text{V}, I_C = 20\text{A},$	-	100	140	nC
Q_{ge}	Gate-emitter charge	$V_{GE} = 15\text{V},$		16		nC
Q_{gc}	Gate-collector charge	(see Figure 18)		45		nC

Table 6. Switching on/off (inductive load)

Symbol	Parameter	Test conditions	Min.	Typ.	Max.	Unit
$t_{d(on)}$	Turn-on delay time	$V_{CC}=390\text{ V}$, $I_C=20\text{ A}$,		31		ns
t_r	Current rise time	$R_G=3.3\ \Omega$, $V_{GE}=15\text{ V}$	-	11	-	ns
$(di/dt)_{onf}$	Turn-on current slope	(see Figure 17)		1600		A/ μs
$t_{d(on)}$	Turn-on delay time	$V_{CC}=390\text{ V}$, $I_C=20\text{ A}$,		31		ns
t_r	Current rise time	$R_G=3.3\ \Omega$, $V_{GE}=15\text{ V}$	-	11.5	-	ns
$(di/dt)_{on}$	Turn-on current slope	$T_j=125^\circ\text{C}$ (see Figure 17)		1500		A/ μs
$t_{r(Voff)}$	Off voltage rise time	$V_{CC}=390\text{ V}$, $I_C=20\text{ A}$,		28		ns
$t_{d(off)}$	Turn-off delay time	$R_G=3.3\ \Omega$, $V_{GE}=15\text{ V}$	-	100	-	ns
t_f	Current fall time	(see Figure 17)		75		ns
$t_{r(Voff)}$	Off voltage rise time	$V_{CC}=390\text{ V}$, $I_C=20\text{ A}$,		66		ns
$t_{d(off)}$	Turn-off delay time	$R_G=3.3\ \Omega$, $V_{GE}=15\text{ V}$	-	150	-	ns
t_f	Current fall time	$T_j=125^\circ\text{C}$ (see Figure 17)		130		ns

Table 7. Switching energy (inductive load)

Symbol	Parameter	Test conditions	Min	Typ.	Max	Unit
$E_{on}^{(1)}$	Turn-on switching losses	$V_{CC}=390\text{ V}$, $I_C=20\text{ A}$,		220	300	μJ
E_{off}	Turn-off switching losses	$R_G=3.3\ \Omega$, $V_{GE}=15\text{ V}$,	-	330	450	μJ
E_{ts}	Total switching losses	(see Figure 19)		550	750	μJ
$E_{on}^{(1)}$	Turn-on switching losses	$V_{CC}=390\text{ V}$, $I_C=20\text{ A}$,		450		μJ
E_{off}	Turn-off switching losses	$R_G=3.3\ \Omega$, $V_{GE}=15\text{ V}$,	-	770		μJ
E_{ts}	Total switching losses	$T_j=125^\circ\text{C}$ (see Figure 19)		1220		μJ

1. E_{on} is the turn-on losses when a typical diode is used in the test circuit in Figure 19. E_{on} include diode recovery energy. If the IGBT is offered in a package with a co-pak diode, the co-pak diode is used as external diode. IGBTs & Diode are at the same temperature (25°C and 125°C).

Table 8. Collector-emitter diode

Symbol	Parameter	Test conditions	Min	Typ.	Max	Unit
V_F	Forward on-voltage	$I_F = 20\text{ A}$ $I_F = 20\text{ A}, T_j = 125^\circ\text{C}$	-	2 1.6	-	V V
t_{rr} Q_{rr} I_{rrm}	Reverse recovery time Reverse recovery charge Reverse recovery current	$I_F = 20\text{ A}, V_R = 40\text{ V},$ $T_j = 25^\circ\text{C}, di/dt = 100\text{ A}/\mu\text{s}$ (see Figure 20)	-	44 66 3	-	ns nC A
t_{rr} Q_{rr} I_{rrm}	Reverse recovery time Reverse recovery charge Reverse recovery current	$I_F = 20\text{ A}, V_R = 40\text{ V},$ $T_j = 125^\circ\text{C},$ $di/dt = 100\text{ A}/\mu\text{s}$ (see Figure 20)	-	88 237 5.4	-	ns nC A

2.1 Electrical characteristics (curves)

Figure 2. Output characteristics

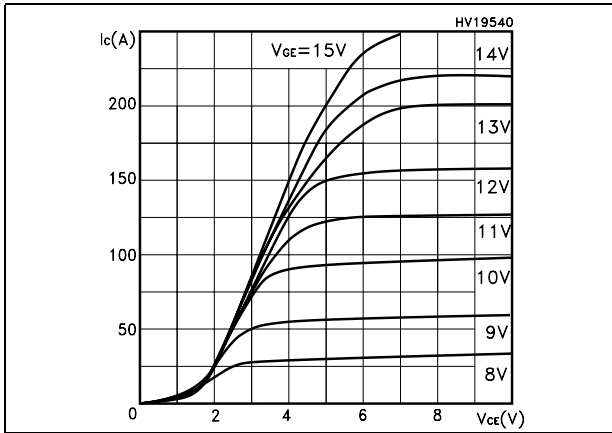

Figure 3. Transfer characteristics

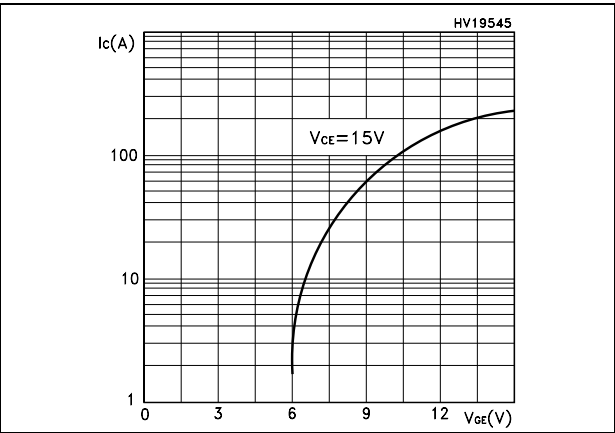

Figure 4. Transconductance

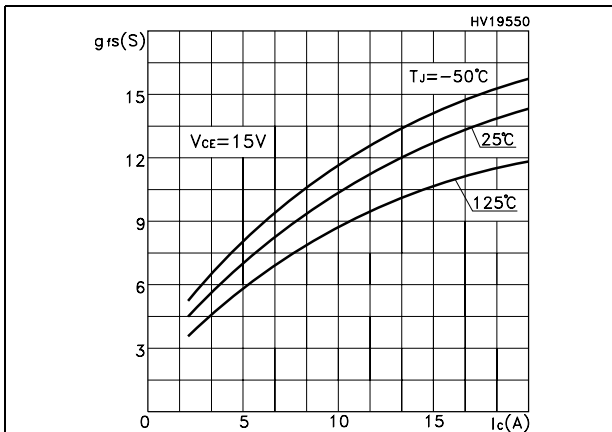

Figure 5. Collector-emitter on voltage vs temperature

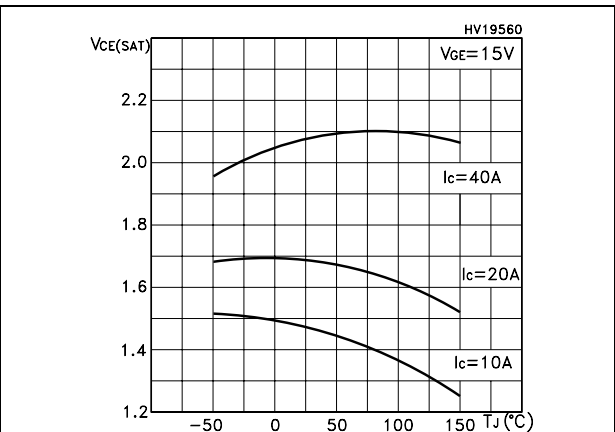

Figure 6. Collector-emitter on voltage vs collector current

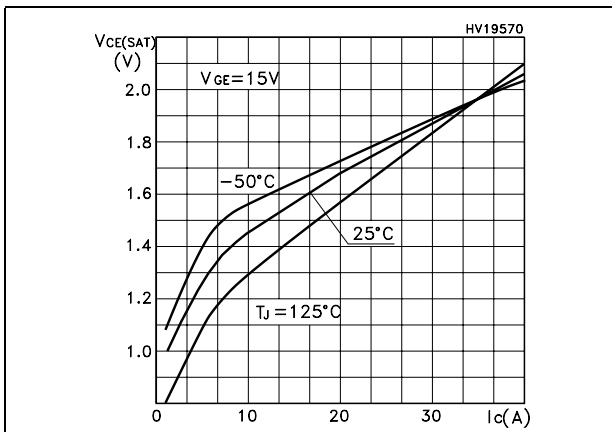

Figure 7. Normalized gate threshold vs temperature

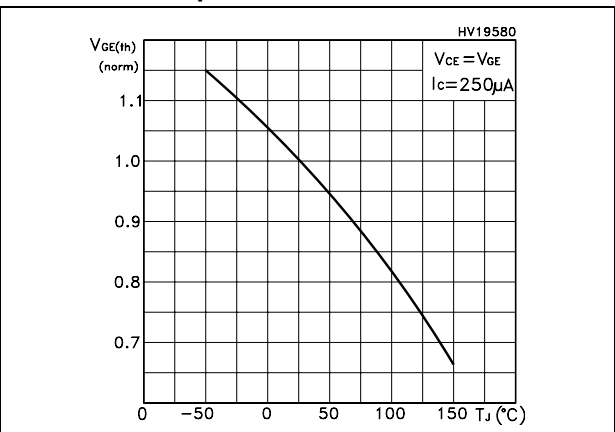

Figure 8. Normalized breakdown voltage vs temperature

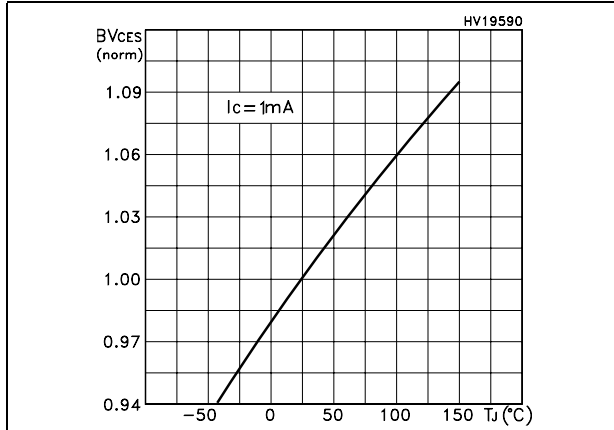

Figure 9. Gate charge vs gate-emitter voltage

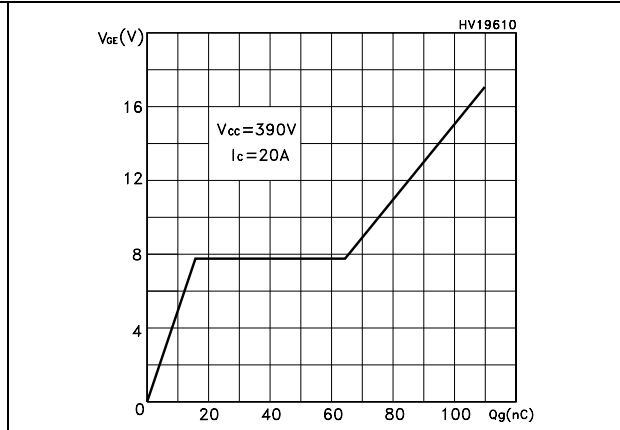

Figure 10. Capacitance variations

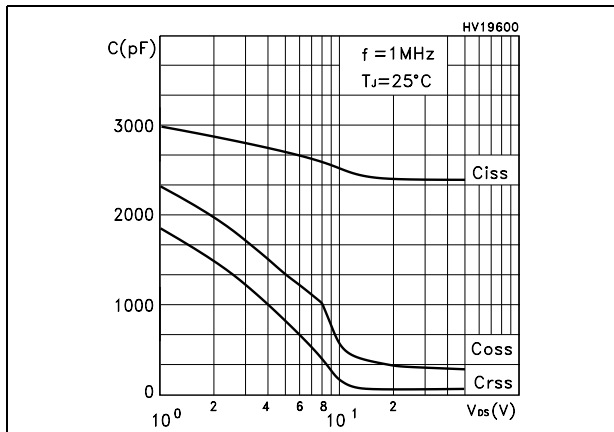

Figure 11. Switching losses vs temperature

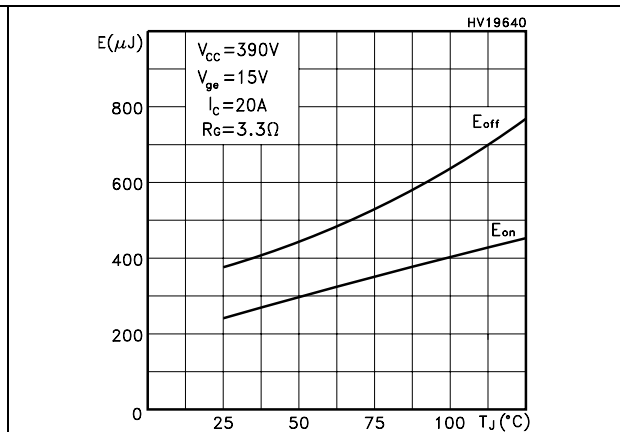

Figure 12. Switching losses vs gate resistance Figure 13. Switching losses vs collector current

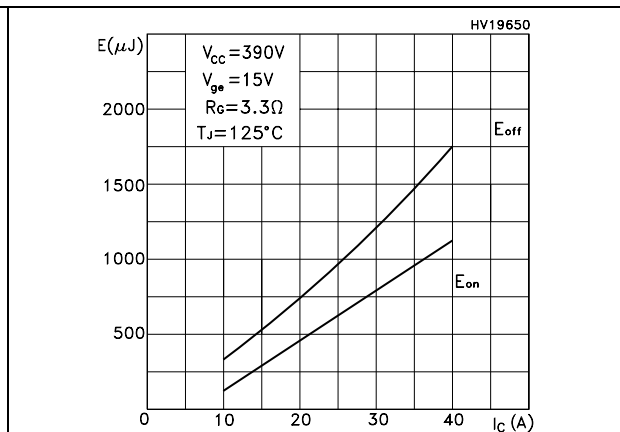
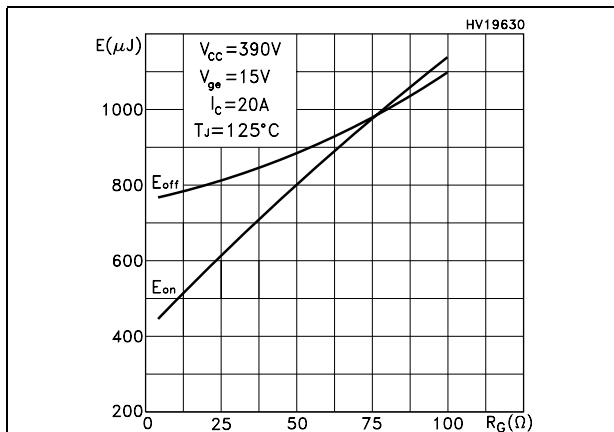

Figure 14. Thermal impedance

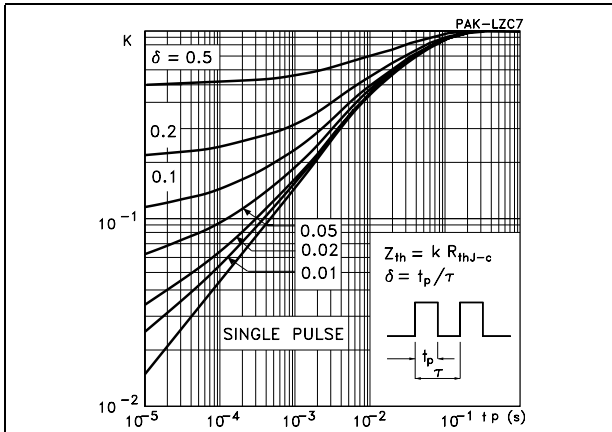

Figure 15. Turn-off SOA

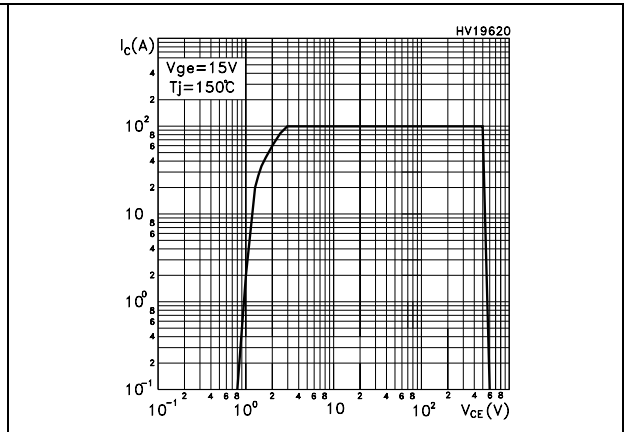
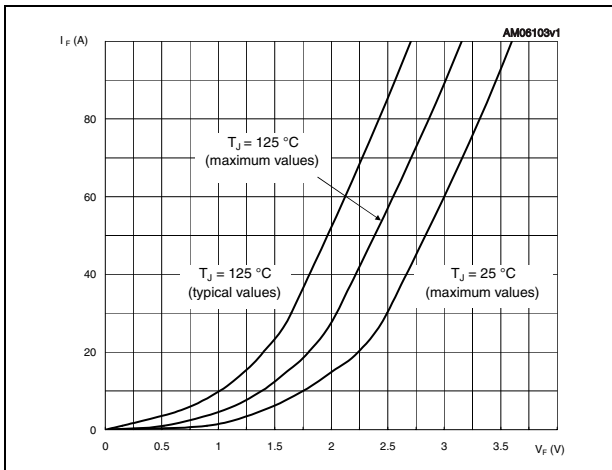

Figure 16. Emitter-collector diode characteristics



4 Package mechanical data

In order to meet environmental requirements, ST offers these devices in different grades of ECOPACK® packages, depending on their level of environmental compliance. ECOPACK® specifications, grade definitions and product status are available at: www.st.com. ECOPACK is an ST trademark.

TO-247 mechanical data

Dim.	mm.		
	Min.	Typ.	Max.
A	4.85		5.15
A1	2.20		2.60
b	1.0		1.40
b1	2.0		2.40
b2	3.0		3.40
c	0.40		0.80
D	19.85		20.15
E	15.45		15.75
e		5.45	
L	14.20		14.80
L1	3.70		4.30
L2		18.50	
øP	3.55		3.65
øR	4.50		5.50
S		5.50	

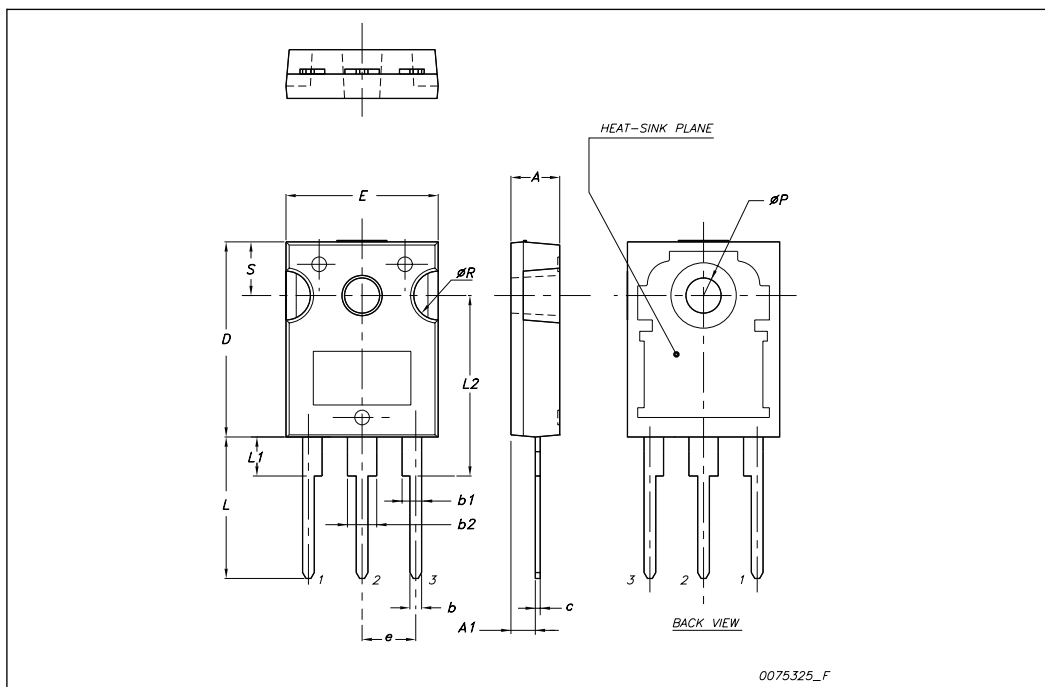

5 Revision history

Table 9. Revision history

Date	Revision	Changes
12-Jul-2004	4	Stylesheet updated. Added switching losses maximum values in <i>Table 7: Switching energy (inductive load)</i> . Inserted <i>Figure 20: Diode recovery times waveform</i> .
09-Mar-2010	5	Inserted I_{FSM} parameter on <i>Table 2: Absolute maximum ratings</i> . Updated <i>Figure 16: Emitter-collector diode characteristics</i> and package mechanical data. Minor text changes to improve readability.

Please Read Carefully:

Information in this document is provided solely in connection with ST products. STMicroelectronics NV and its subsidiaries ("ST") reserve the right to make changes, corrections, modifications or improvements, to this document, and the products and services described herein at any time, without notice.

All ST products are sold pursuant to ST's terms and conditions of sale.

Purchasers are solely responsible for the choice, selection and use of the ST products and services described herein, and ST assumes no liability whatsoever relating to the choice, selection or use of the ST products and services described herein.

No license, express or implied, by estoppel or otherwise, to any intellectual property rights is granted under this document. If any part of this document refers to any third party products or services it shall not be deemed a license grant by ST for the use of such third party products or services, or any intellectual property contained therein or considered as a warranty covering the use in any manner whatsoever of such third party products or services or any intellectual property contained therein.

UNLESS OTHERWISE SET FORTH IN ST'S TERMS AND CONDITIONS OF SALE ST DISCLAIMS ANY EXPRESS OR IMPLIED WARRANTY WITH RESPECT TO THE USE AND/OR SALE OF ST PRODUCTS INCLUDING WITHOUT LIMITATION IMPLIED WARRANTIES OF MERCHANTABILITY, FITNESS FOR A PARTICULAR PURPOSE (AND THEIR EQUIVALENTS UNDER THE LAWS OF ANY JURISDICTION), OR INFRINGEMENT OF ANY PATENT, COPYRIGHT OR OTHER INTELLECTUAL PROPERTY RIGHT.

UNLESS EXPRESSLY APPROVED IN WRITING BY AN AUTHORIZED ST REPRESENTATIVE, ST PRODUCTS ARE NOT RECOMMENDED, AUTHORIZED OR WARRANTED FOR USE IN MILITARY, AIR CRAFT, SPACE, LIFE SAVING, OR LIFE SUSTAINING APPLICATIONS, NOR IN PRODUCTS OR SYSTEMS WHERE FAILURE OR MALFUNCTION MAY RESULT IN PERSONAL INJURY, DEATH, OR SEVERE PROPERTY OR ENVIRONMENTAL DAMAGE. ST PRODUCTS WHICH ARE NOT SPECIFIED AS "AUTOMOTIVE GRADE" MAY ONLY BE USED IN AUTOMOTIVE APPLICATIONS AT USER'S OWN RISK.

Resale of ST products with provisions different from the statements and/or technical features set forth in this document shall immediately void any warranty granted by ST for the ST product or service described herein and shall not create or extend in any manner whatsoever, any liability of ST.

ST and the ST logo are trademarks or registered trademarks of ST in various countries.

Information in this document supersedes and replaces all information previously supplied.

The ST logo is a registered trademark of STMicroelectronics. All other names are the property of their respective owners.

© 2010 STMicroelectronics - All rights reserved

STMicroelectronics group of companies

Australia - Belgium - Brazil - Canada - China - Czech Republic - Finland - France - Germany - Hong Kong - India - Israel - Italy - Japan - Malaysia - Malta - Morocco - Philippines - Singapore - Spain - Sweden - Switzerland - United Kingdom - United States of America

www.st.com