

# Combo Tester X3 Installation, Operation and Maintenance



Made in the  
United States of America



Figure 1. Desco Combo Tester X3 and Dual Foot Plate

## Description

The Desco Combo Tester X3 verifies the functionality of an operator's wrist strap and footwear. It determines if an operator's wrist strap and footwear will function correctly. The operator's wrist strap and footwear will test simultaneously with no need for separate tests. Green lights indicate that the wrist strap and footwear are passing. Red lights and an audible alarm indicate when the wrist strap and/or footwear (left or right) are failing. If failure occurs, the tester will also display if the grounding device's resistance is too low or too high.

The Combo Tester X3 features a reliable and durable solid-state switch which replaces the traditional mechanical test switch with a spring and moving parts. The outer and inner portions of the solid-state switch are designed to be bridged by a person's skin. The Combo Tester X3 is compatible with both single-wire and dual-wire wrist straps.

The factory test limits are set to:

- Wrist Straps: 750 kilohms and 10 megohms
- Footwear: 750 kilohms and 35 megohms

(See page 3 for alternate test limit settings)

Each Combo Tester X3 is calibrated with accepted procedures and standards traceable to the National Institute of Standards and Technology (NIST) and includes a NIST certificate.

The Combo Tester X3 and its accessories are available as the following item numbers:

Item	Description
<a href="#">19278</a>	Combo Tester X3
<a href="#">19279</a>	Combo Tester X3 with Stand
<a href="#">19255</a>	Stand, for Combo Tester X3
<a href="#">50755</a>	ESD Glove Test Fixture
<a href="#">50424</a>	Limit Comparator
<a href="#">19262</a>	Power Adapter, 100-240VAC Input, 12VDC 0.5A Output, All Plugs
<a href="#">50406</a>	Replacement Dual Foot Plate
<a href="#">62103</a>	Replacement Foot Plate Cord
<a href="#">19274</a>	Replacement Ground Cord

Per ANSI/ESD S20.20 section 7.3 "A Compliance Verification Plan shall be established to ensure the Organization's fulfillment of the technical requirements of the ESD Control Program Plan. Process monitoring (measurements) shall be conducted in accordance with a Compliance Verification Plan that identifies the technical requirements to be verified, the measurement limits and the frequency at which those verifications shall occur. The Compliance Verification Plan shall document the test methods and equipment used for process monitoring and measurements. ... The test equipment selected shall be capable of making the measurements defined in the Compliance Verification Plan."

Per ANSI/ESD S1.1 Annex A.3 Frequency of System Testing "The wrist strap system should be tested daily to ensure proper electrical resistance."

Per ESD Handbook ESD TR20.20 section 5.3.2.4.2 Additional User Wrist Strap Testing "Proper testing of the wrist strap includes the resistance of the groundable point on the end of the cord, the cord itself, the resistor, the cord-to-cuff snap connector, the resistance of the interface of the cuff, the cuff/wrist interface, and the resistance of the person between the wrist and the hand that contacts the test electrode."

Per ESD Handbook ESD TR20.20 section 5.3.2.2.2 Wrist Strap Ground Cord "At first glance, the ground cord appears to be a relatively simple assembly. However, the design requirements are considerable, given the wide range of user applications and the durability requirements of constant tugging, flexing, and dragging over the edge of workstation tops and equipment chassis."

“Compliance verification should be performed prior to each use (daily, shift change, etc.). The accumulation of insulative materials may increase the foot grounder system resistance. If foot grounders are worn outside the ESD protected area testing for functionality before reentry to the ESD protected area should be considered.” (ESD SP9.2 APPENDIX B - Foot Grounder Usage Guidance)

“Compliance verification records shall be established and maintained to provide evidence of conformity to the technical requirements.” (ANSI/ESD S20.20 section 7.3)

## Packaging

### 19278 COMBO TESTER X3

- 1 Combo Tester X3
- 1 Dual Foot Plate
- 1 Power Adapter, 12VDC, with interchangeable plugs (North America, UK/Asia, Europe)
- 1 Foot Plate Cord, 6'
- 1 Ground Cord
- 1 Certificate of Calibration

### 19255 STAND, FOR COMBO TESTER X3

- 1 Pedestal
- 1 Baseplate
- 2 Socket Head Screws, 1/4-20 x 3/4"
- 2 Pan Head Screws, 10-32 x 5/8"
- 2 Nuts, 10-32
- 4 Pan Head Screws, #4 x 3/4"

## Features and Components



Figure 2. Dual Combination Tester features and components

**A. Test Limit DIP Switch:** Use this DIP switch to configure the resistance limits of the tester. See the section titled “Tester Configuration” for more information.

**B. Footwear Status LEDs:** Displays the footwear test results.

**C. 12VDC Power Jack:** Connect the included power adapter here to power the Combo Tester X3.

**D. Steady-State Test Switch:** Place and hold your finger here to begin the test.

**E. Single-Wire Wrist Strap Jack:** Insert your single-wire wrist cord here to test your wrist strap.

**F. Dual-Wire Wrist Strap Jack:** Insert your dual-wire wrist cord here to test your wrist strap.

**G. Wrist Strap Status LEDs:** Displays the wrist strap test results.

**H. Relay Terminal:** Can be integrated with electronic door locks, lights, buzzers, etc. It is capable of switching up to 1A @ 30VDC or .5A @ 125VAC.

Terminals 1 & 2 = Normally Closed  
Terminals 2 & 3 = Normally Open

NOTE: All tests must pass in order for the relay to activate. The relay timer lasts approximately 2.5 seconds and cannot be modified. The timer starts once the finger is removed from the test switch.

**I. Ground Jack:** Insert the banana plug end of the included ground cord to this jack. Connect the ring terminal end of the cord to equipment ground. This connection will remove any static charge from the user before the test. **NOTE: Failure to correctly ground the Combo Tester X3 may result in damage not covered under warranty.**

**J. Foot Plate Jack:** Connect one end of the foot plate cable cord and the other end to the dual foot plate.

**K. Buzzer Volume Adjustment:** Turn the trimpot clockwise to increase the buzzer volume and counter-clockwise to decrease the volume.

# Installation

## TESTER CONFIGURATION

The resistance limits for footwear and wrist strap tests are controlled by the DIP switches located on the left side of the Combo Tester X3. Use the following tables for the DIP switch settings and their corresponding test values.

### Footwear Resistance

DIP switches 1 and 2 control the HIGH test limit.

Switch 1	Switch 2	HIGH Limit Resistance
ON	ON	10 Megohms ( $1 \times 10^7$ )
OFF	OFF	35 Megohms ( $3.5 \times 10^7$ )
ON	OFF	100 Megohms ( $1 \times 10^8$ )
OFF	ON	1 Gigohm ( $1 \times 10^9$ )

DIP switches 3 and 4 control the LOW test limit.

Switch 3	Switch 4	LOW Limit Resistance
OFF	OFF	footwear test disabled
ON	OFF	100 Kilohms ( $1 \times 10^5$ )
OFF	ON	750 Kilohms ( $7.5 \times 10^5$ )

default setting

NOTE: At 1 Gigohm high limit resistance, a dirty foot plate could result in a false pass. Be sure to keep the foot plate clean particularly when using this setting. This setting is not suitable for relative humidity greater than 50%.

### Wrist Strap Resistance

DIP switches 5 and 6 control the HIGH test limit.

Switch 5	Switch 6	HIGH Limit Resistance
OFF	OFF	wrist strap test disabled
ON	ON	10 Megohms ( $1 \times 10^7$ )
ON	OFF	35 Megohms ( $3.5 \times 10^7$ )

default setting

DIP switch 5 must be ON (default setting) for the wrist strap test to be active. The wrist strap test will be disabled if DIP switch 5 is set to OFF.

The LOW limit for the wrist strap test is set to 750 kilohms and cannot be modified by the user.

## INSTALLING THE COMBO TESTER X3

1. Mount the tester at the desired location using the four mounting holes located in the corners of the yellow mounting plate.
2. Set the Dual Foot Plate below the tester.
3. Insert one end of the foot plate cord into the stereo jack located at the bottom of the tester. Insert the opposite end of the cord into the stereo jack located at the back of the foot plate.
4. Use the guide located on the bottom of the foot plate to route the cord out of the side. This will prevent the foot plate cord from being accidentally tripped and unplugged.

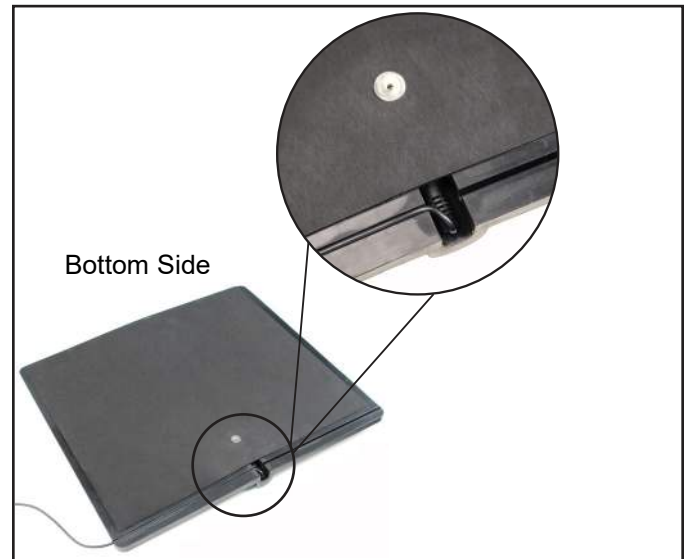

Figure 3. Routing the foot plate cord through the foot plate's guide

5. Insert the ground cord's banana plug into the ground jack located at the bottom of the tester. Connect ground cord's ring terminal to equipment ground. This connection will remove any static charge from the user before the test. **NOTE: Failure to correctly ground the Combo Tester X3 may result in damage not covered under warranty.**
6. Power the Combo Tester X3 using the included power supply.

## INSTALLING THE COMBO TESTER X3 AND STAND

1. Insert the pedestal to the baseplate with the mounting bracket sloping toward the operator. Be sure to align the screw holes located at the base of the pedestal.
2. Use the two 1/4-20 socket cap screws to secure the pedestal to the baseplate.

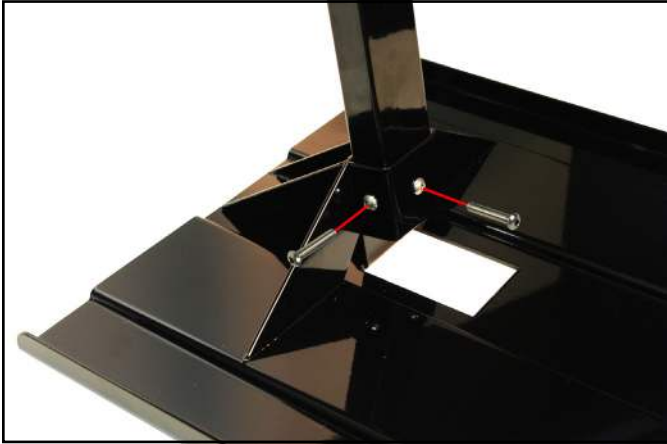

Figure 4. Securing the pedestal to the baseplate using the 2 socket cap screws

3. Route the ground and foot plate cords through the pedestal. Feed the cords from the bottom and have them exit through the top.

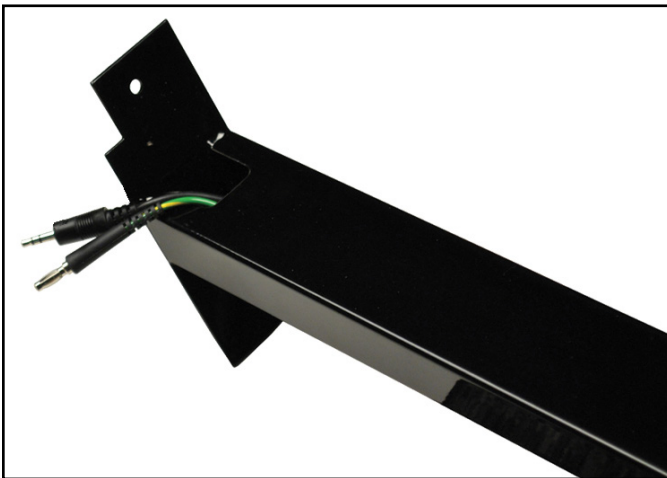

Figure 5. Routing the ground and foot plate cords through the pedestal

4. Align the backplate's two holes located above and below the tester to the two holes on the pedestal's mounting bracket. Secure the backplate using the two included 10-32 pan head screws and nuts.



Figure 6. Securing the Combo Tester X3 to the pedestal

5. Insert one end of the foot plate cord into the foot plate jack located at the bottom of the tester. Connect the other end of the foot plate cord into the jack located on the dual foot plate.
6. Insert the ground cord's banana plug into the ground jack located at the bottom of the tester. Connect ground cord's ring terminal to equipment ground. This connection will remove any static charge from the user before the test. **NOTE: Failure to correctly ground the Combo Tester X3 may result in damage not covered under warranty.**
7. Fit the dual foot plate into a position so that it is flush with the front and top of the baseplate. Secure the dual foot plate to the baseplate using the four included #4 pan head screws.

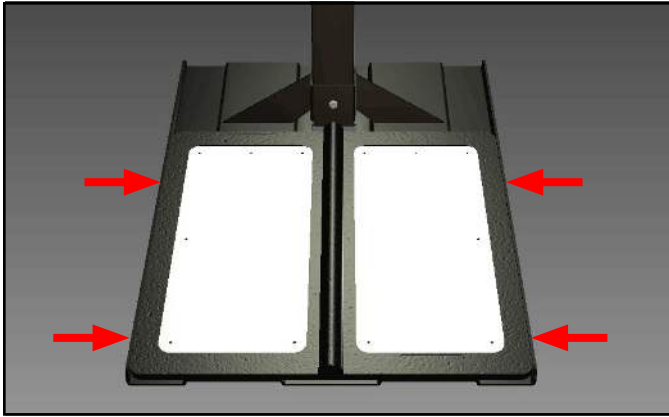

Figure 7. Securing the dual foot plate to the baseplate

8. Power the Combo Tester X3 using the included power supply.

### WIRING THE COMBO TESTER X3 TO AN ACCESS CONTROL SYSTEM

The Combo Tester X3 may be connected to an Access Control System to grant access when both a valid proximity badge is read and PASS test results are achieved at the tester. Figure 8 shows an example when using a turnstile.

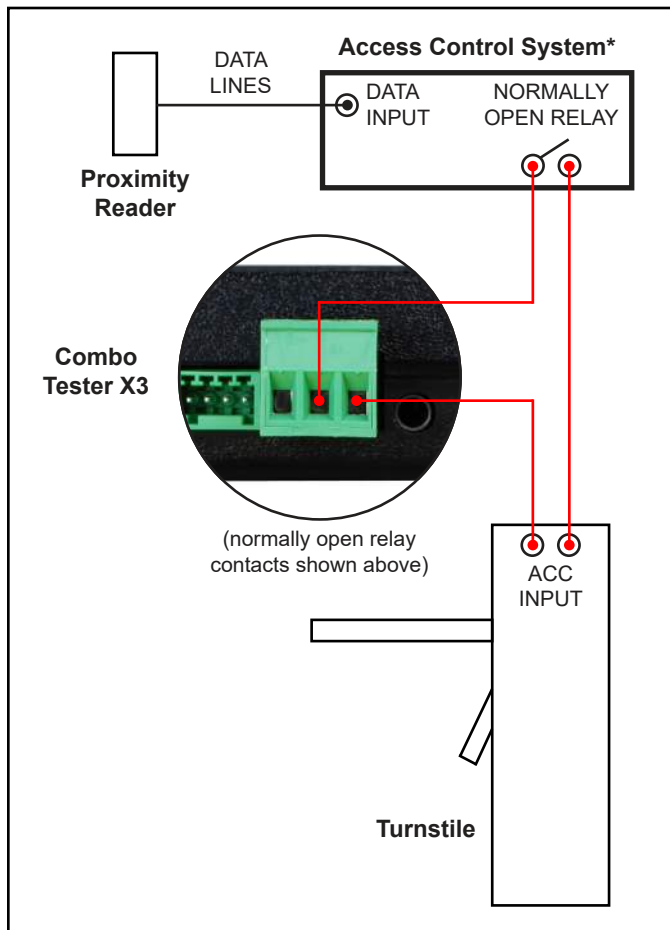

Figure 8. Wiring the Combo Tester X3 to an Access Control System

\*NOTE: The Access Control System must have a time delay feature in order to achieve the configuration described above. Set the Access Control System's relay to remain active for a few seconds when a valid proximity badge is accepted. The relay will need to remain active long enough for an operator to perform a test on the Combo Tester X3. The access control device will only unlock when it receives an active signal from both the Access Control System and Combo Tester X3.

### Operation

1. A circling light around the test switch indicates when the Combo Tester X3 is on standby and ready to perform a test.

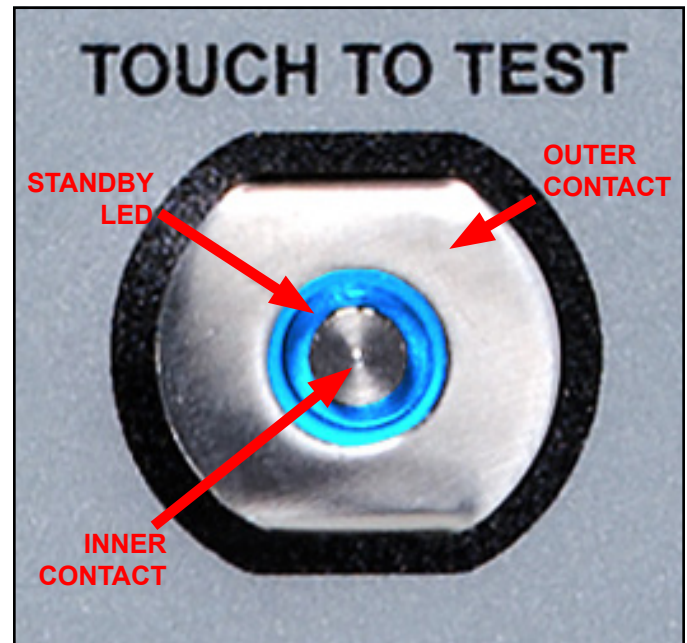

Figure 9. Steady-State Test Switch features and components

2. While wearing a wrist strap and/or ESD footwear, plug the wrist cord into its corresponding jack located on the face of the Combo Tester X3. Place one foot on each foot plate.
3. To begin the test, use your finger to bridge the test switch's inner and outer contacts. The blue standby LED will become solid to indicate that the test has been initiated. Hold your finger down until the test results are displayed.

If your finger is removed too early, the tester's LEDs will blink three times to indicate that the test was not completed. DO NOT touch any other metal while performing your test as this will affect your results.

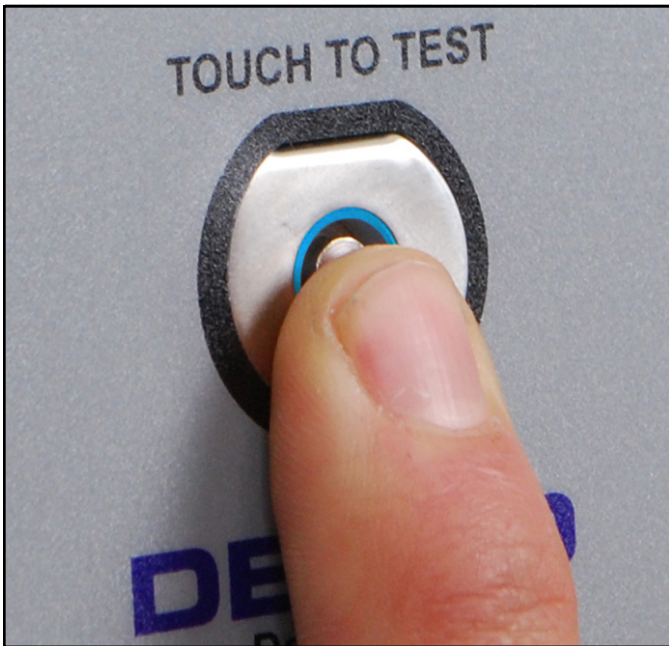

Figure 10. Bridging the test switch's contacts to initiate the test

4. A "PASS" test result is indicated by illumination of the green LEDs. A "FAIL LOW" test result is indicated by illumination of the red LEDs. A "FAIL HIGH" test result is indicated by illumination of the yellow LEDs.

If your ESD test fails, check your wrist strap and footwear to ensure that they are being worn correctly and/or need to be replaced.

NOTE: Failures may be caused by dry skin or minimal sweat layer. For wrist straps, try using an approved dissipative hand lotion such as [Menda Reztore™ ESD Hand Lotion](#) to your wrist prior to use. Footwear test results can be improved by taking a short walk to build a sweat layer for better conductivity.

The Combo Tester X3 may also be used to test smocks or garments that feature a grounding mechanism for operators using a coiled cord connection.



Figure 11. Using the 19278 Combo Tester X3



Figure 12. Using the 19279 Combo Tester X3 with Stand

## Maintenance

To maintain optimum performance, cleaning should be performed on a regular basis. Use a minimum of 80% Isopropyl alcohol to clean the foot plate and test switch. Other cleaners are susceptible to leaving residue on these surfaces.

## Calibration

The Combo Tester X3 is calibrated to standards traceable to NIST. Frequency of recalibration should be based on the critical nature of those ESD sensitive items handled and the risk of failure for the ESD protective equipment and materials. In general, we recommend that calibration be performed annually.

The accuracy of the Combo Tester X3 is specified as:

±20% for 1 gigohm footwear test limit  
 ±10% for all other test limits

A periodic check using a precision resistance box can be used to verify proper operation.

The EMIT [50424](#) Limit Comparator is available for the convenient calibration of the Combo Tester X3.

The Limit Comparator allows the customer to perform NIST traceable calibration on the Combo Tester X3. The Limit Comparator can be used on the shop floor within a few minutes, virtually eliminating downtime, verifying that the Combo Tester X3 is operating within tolerances.

See [TB-6581](#) for more information.

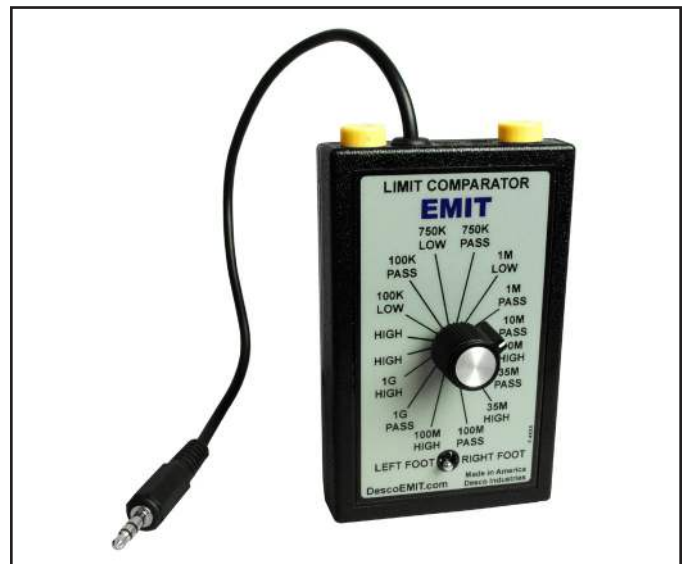

Figure 13. EMIT 50424 Limit Comparator

# Specifications

## Combo Tester X3

Input Voltage and Frequency (External Adapter)	AC/DC Power Adapter Power Input: 100-240VAC, 50/60 Hz  Power Output: 12VDC, 0.5A  Cable Length: 6 ft. (1.83 m)
--	--

Operating Temperature	70°F to 85°F (21°C to 30°C) for 1 gigohm test limit  41°F to 85°F (5°C to 30°C) for all other test limits
-----------------------	---

Environmental Requirements	Indoor use only at altitudes less than 6500 ft. (2 km)  Maximum relative humidity of 80% up to 85°F (30°C) decreasing linearly to 50% @ 85°F (30°C)  Maximum relative humidity of 50% at 1 gigohm setting
----------------------------	---

Dimensions (with mounting plate)	11.35" x 7.75" x 1.47" (288 mm x 197 mm x 37 mm)
----------------------------------	---

Weight (with mounting plate)	1.2 lbs (0.5 kg)
------------------------------	------------------

Test Accuracy	±20% for 1 gigohm footwear test limit  ±10% for all other test limits
---------------	---

Test Switch Voltage	5 VDC @ open circuit
---------------------	----------------------

Wrist Strap and Footwear Test Voltage	30 VDC @ open circuit  Test current is limited by resistors and varies on the test range setting (100 kilohms - 1 gigohm)
---------------------------------------	---

Relay Contact Rating	1A @ 30VDC max
----------------------	----------------

## Dual Foot Plate

Dimensions	14.0" x 16.0" x 0.9" (356 mm x 406 mm x 23 mm)
------------	---

Weight	7.5 lbs (3.4 kg)
--------	------------------

**Limited Warranty, Warranty Exclusions, Limit of Liability and RMA Request Instructions**  
See the Desco Warranty - [Desco.com/Limited-Warranty.aspx](http://Desco.com/Limited-Warranty.aspx)