

**HVIC**  
**High Voltage**  
**Half-Bridge Driver**  
**600 Volts/+120mA/-250mA**

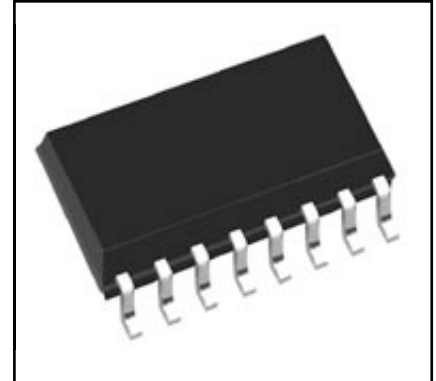
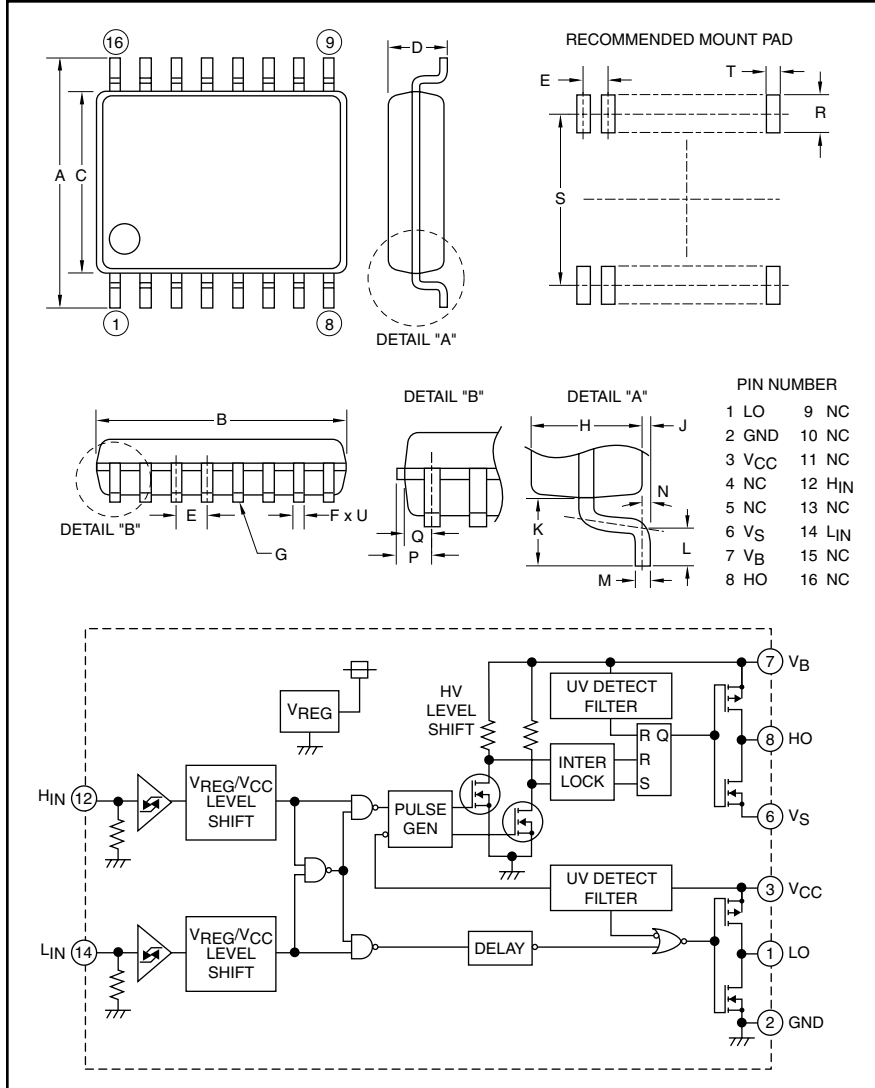

**Description:**  
M81708FP is a high voltage Power MOSFET and IGBT module driver for half-bridge applications.

- Features:**
- Shoot Through Interlock
  - Output Current +120mA/-250mA
  - Half-Bridge Driver
  - SOP-16 Package

- Applications:**
- HID Ballast
  - PDP
  - MOSFET Driver
  - IGBT Driver
  - Inverter Module Control

**Ordering Information:**  
M81708FP is a +120mA/-250mA, 600 Volt HVIC, High Voltage Half-Bridge Driver

**Outline Drawing and Circuit Diagram**

Dimensions	Inches	Millimeters
A	0.31±0.01	7.8±0.3
B	0.41±0.004	10.1±0.1
C	0.21±0.004	5.3±0.1
D	0.12	2.10
E	0.05	1.27
F	0.02±0.002	0.4±0.05
G	0.004	0.1
H	0.07	1.8
J	0.01±0.004	0.1±0.1
K	0.05	1.25

Dimensions	Inches	Millimeters
L	0.024±0.008	0.6±0.2
M	0.1±0.002	0.2±0.05
N	8°	8°
P	0.03	0.755
Q	0.023	0.605
R	0.05 Min.	1.27 Min.
S	0.30	7.62
T	0.029	0.76
U	0.098 Dia.	0.25 Dia.



Powerex, Inc., 200 E. Hillis Street, Youngwood, Pennsylvania 15697-1800 (724) 925-7272

**M81708FP**

**HVIC, High Voltage Half-Bridge Driver**

600 Volts/+120mA/-250mA

**Absolute Maximum Ratings,  $T_a = 25^\circ\text{C}$  unless otherwise specified**

Characteristics	Symbol	M81708FP	Units
High Side Floating Supply Absolute Voltage	$V_B$	-0.5 ~ 624	Volts
High Side Floating Supply Offset Voltage	$V_S$	$V_B - 24 \sim V_B + 0.5$	Volts
High Side Floating Supply Voltage ( $V_{BS} = V_B - V_S$ )	$V_{BS}$	-0.5 ~ 24	Volts
High Side Output Voltage	$V_{HO}$	$V_S - 0.5 \sim V_B + 0.5$	Volts
Low Side Fixed Supply Voltage	$V_{CC}$	-0.5 ~ 24	Volts
Low Side Output Voltage	$V_{LO}$	-0.5 ~ $V_{CC} + 0.5$	Volts
Logic Input Voltage ( $H_{IN}, L_{IN}$ )	$V_{IN}$	-0.5 ~ $V_{CC} + 0.5$	Volts
Allowable Offset Voltage Transient	dVs/dt	$\pm 50$	V/ns
Package Power Dissipation ( $T_a = 25^\circ\text{C}$ , On Board)	$P_d$	0.84	Watts
Linear Derating Factor ( $T_a > 25^\circ\text{C}$ , On Board)	$K_\theta$	8.4	mW/ $^\circ\text{C}$
Junction to Case Thermal Resistance	$R_{th(j-c)}$	50	$^\circ\text{C}/\text{W}$
Junction Temperature	$T_j$	-20 ~ 125	$^\circ\text{C}$
Operation Temperature	$T_{opr}$	-20 ~ 100	$^\circ\text{C}$
Storage Temperature	$T_{stg}$	-40 ~ 125	$^\circ\text{C}$

**Recommended Operating Conditions**

Characteristics	Symbol	Test Conditions	Min.	Typ.	Max.	Units
High Side Floating Supply Absolute Voltage	$V_B$		$V_S + 10$	—	$V_S + 20$	Volts
High Side Floating Supply Offset Voltage	$V_S$	$V_B > 10\text{V}$	-5	—	500	Volts
High Side Floating Supply Voltage	$V_{BS}$	$V_B = V_B - V_S$	10	—	20	Volts
High Side Output Voltage	$V_{HO}$		$V_S$	—	$V_B$	Volts
Low Side Fixed Supply Voltage	$V_{CC}$		10	—	20	Volts
Logic Supply Voltage	$V_{LO}$		0	—	$V_{CC}$	Volts
Logic Input Voltage	$V_{IN}$	$H_{IN}, L_{IN}$	0	—	$V_{CC}$	Volts

**Electrical Characteristics**

$T_a = 25^\circ\text{C}$ ,  $V_{CC} = V_{BS} (= V_B - V_S) = 15\text{V}$  unless otherwise specified

Characteristics	Symbol	Test Conditions	Min.	Typ.	Max.	Units
Floating Supply Leakage Current	$I_{FS}$	$V_B = V_S = 600\text{V}$	—	—	1.0	$\mu\text{A}$
$V_{BS}$ Standby Current	$I_{BS}$	$H_{IN} = L_{IN} = 0\text{V}$	—	0.2	0.5	mA
$V_{CC}$ Standby Current	$I_{CC}$	$H_{IN} = L_{IN} = 0\text{V}$	0.2	0.5	1.0	mA
High Level Output Voltage	$V_{OH}$	$I_O = 0\text{A}, L_O, H_O$	14.9	—	—	Volts
Low Level Output Voltage	$V_{OL}$	$I_O = 0\text{A}, L_O, H_O$	—	—	0.1	Volts
High Level Input Threshold Voltage	$V_{IH}$	$H_{IN}, L_{IN}$	2.1	3.0	4.0	Volts
Low Level Input Threshold Voltage	$V_{IL}$	$H_{IN}, L_{IN}$	0.6	1.5	2.0	Volts
High Level Input Bias Current	$I_{IH}$	$V_{IN} = 5\text{V}$	—	5	20	$\mu\text{A}$
Low Level Input Bias Current	$I_{IL}$	$V_{IN} = 0\text{V}$	—	—	2.0	$\mu\text{A}$
$V_{BS}$ Supply UV Reset Voltage	$V_{BSuvr}$		8.0	8.9	9.8	Volts
$V_{BS}$ Supply UV Hysteresis Voltage	$V_{BSuvh}$		0.3	0.7	—	Volts
$V_{BS}$ Supply UV Filter Time	$t_{VBSuv}$		—	7.5	—	$\mu\text{s}$
$V_{CC}$ Supply UV Reset Voltage	$V_{CCuvr}$		8.0	8.9	9.8	Volts

**M81708FP**

**HVIC, High Voltage Half-Bridge Driver**

600 Volts/+120mA/-250mA

**Electrical Characteristics**

**T<sub>a</sub> = 25°C, V<sub>CC</sub> = V<sub>BS</sub> (= V<sub>B</sub> - V<sub>S</sub>) = 15V unless otherwise specified**

Characteristics	Symbol	Test Conditions	Min.	Typ.	Max.	Units
V <sub>CC</sub> Supply UV Hysteresis Voltage	V <sub>CCuvh</sub>		0.3	0.7	—	Volts
V <sub>CC</sub> Supply UV Filter Time	t <sub>VCCuv</sub>		—	7.5	—	μs
Output High Level Short Circuit Pulsed Current	I <sub>OH</sub>	V <sub>O</sub> = 0V, V <sub>IN</sub> = 5V, P <sub>W</sub> < 10μs	120	200	—	mA
Output Low Level Short Circuit Pulsed Current	I <sub>OL</sub>	V <sub>O</sub> = 15V, V <sub>IN</sub> = 0V, P <sub>W</sub> < 10μs	250	350	—	mA
Output High Level ON Resistance	R <sub>OH</sub>	I <sub>O</sub> = -20mA, R <sub>OH</sub> = (V <sub>OH</sub> - V <sub>O</sub> )/I <sub>O</sub>	—	35	70	Ω
Output Low Level ON Resistance	R <sub>OL</sub>	I <sub>O</sub> = 20mA, R <sub>OL</sub> = V <sub>O</sub> /I <sub>O</sub>	—	15	30	Ω
High Side Turn-On Propagation Delay	t <sub>dLH(HO)</sub>	C <sub>L</sub> = 1000pF between HO - V <sub>S</sub>	105	140	175	ns
High Side Turn-Off Propagation Delay	t <sub>dHL(HO)</sub>	C <sub>L</sub> = 1000pF between HO - V <sub>S</sub>	95	130	165	ns
High Side Turn-On Rise Time	t <sub>rH</sub>	C <sub>L</sub> = 1000pF between HO - V <sub>S</sub>	—	100	220	ns
High Side Turn-Off Fall Time	t <sub>fH</sub>	C <sub>L</sub> = 1000pF between HO - V <sub>S</sub>	—	50	80	ns
LowSide Turn-On Propagation Delay	t <sub>dLH(LO)</sub>	C <sub>L</sub> = 1000pF between LO - GND	105	140	175	ns
Low Side Turn-Off Propagation Delay	t <sub>dHL(LO)</sub>	C <sub>L</sub> = 1000pF between LO - GND	95	130	165	ns
Low Side Turn-On Rise Time	t <sub>rL</sub>	C <sub>L</sub> = 1000pF between LO - GND	—	100	220	ns
Low Side Turn-Off Fall Time	t <sub>fL</sub>	C <sub>L</sub> = 1000pF between LO - GND	—	50	80	ns
Delay Matching, High Side and Low Side Turn-On	Δt <sub>dLH</sub>	t <sub>dLH(HO)</sub> - t <sub>dLH(LO)</sub>	—	—	30	ns
Delay Matching, High Side and Low Side Turn-Off	Δt <sub>dHL</sub>	t <sub>dHL(HO)</sub> - t <sub>dHL(LO)</sub>	—	—	30	ns

**THERMAL DERATING FACTOR CHARACTERISTICS**

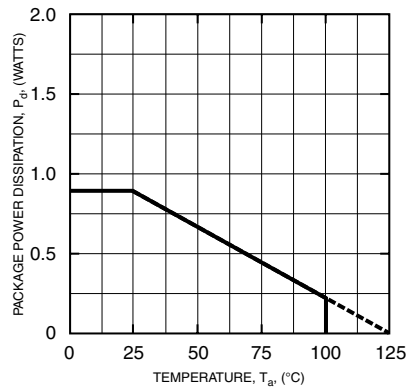

**FUNCTION TABLE (X : HORL)**

H <sub>IN</sub>	L <sub>IN</sub>	V <sub>BS</sub> U <sub>v</sub>	V <sub>CC</sub> U <sub>v</sub>	HO	LO	Behavioral State
L	L	H	H	L	L	LO = HO = Low
L	H	H	H	L	H	LO = High
H	L	H	H	H	L	HO = High
H	H	H	H	L	L	LO = HO = Low
X	L	L	H	L	L	HO = Low, V <sub>BS</sub> U <sub>v</sub> Tripped
X	H	L	H	L	H	LO = High, V <sub>BS</sub> U <sub>v</sub> Tripped
L	X	H	L	L	L	LO = Low, V <sub>CC</sub> U <sub>v</sub> Tripped
H	X	H	L	L	L	HO = LO = Low, V <sub>CC</sub> U <sub>v</sub> Tripped

NOTE: "L" state of V<sub>BS</sub> U<sub>v</sub>, V<sub>CC</sub> U<sub>v</sub> means that U<sub>v</sub> trip voltage.  
In the case of both input signals (H<sub>IN</sub> and L<sub>IN</sub>) are "H", output signals (HO and LO) become "L".

**M81708FP**

**HVIC, High Voltage Half-Bridge Driver**

600 Volts/+120mA/-250mA

**TIMING DIAGRAM**

**1. Input/Output Timing Diagram**

HIGH ACTIVE – When input signal ( $H_{IN}$  or  $L_{IN}$ ) is “H”, then output signal ( $H_O$  or  $L_O$ ) is “H”. In the case of both input signals ( $H_{IN}$  and  $L_{IN}$ ) are “H”, then output signals ( $H_O$  and  $L_O$ ) become “L”.

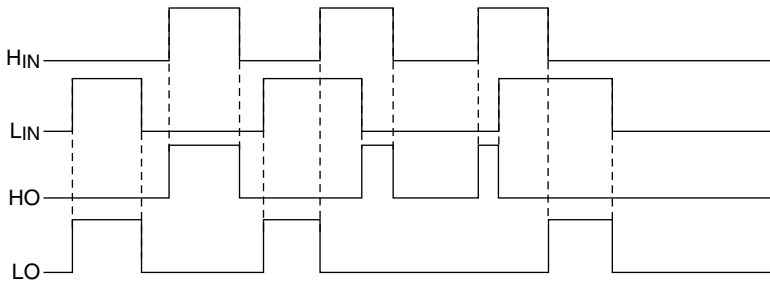

**2. VCC(VBS) Supply Under Voltage Lockout Timing Diagram**

When  $V_{CC}$  supply voltage keeps lower UV trip voltage ( $V_{CCuvt} = V_{CCuvr} - V_{CCuvh}$ ) for  $V_{CC}$  supply UV filter time, output signal becomes “L”. And then, when  $V_{CC}$  supply voltage is higher than UV reset voltage, output signal  $L_O$  becomes “H”.

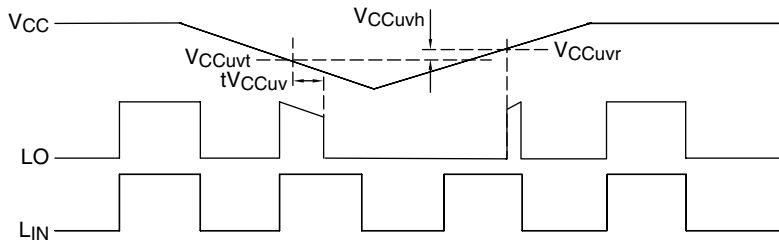

When  $V_{CC}$  supply voltage keeps lower UV trip voltage ( $V_{CCuvt} = V_{CCuvr} - V_{CCuvh}$ ) for  $V_{CC}$  supply UV filter time, output signal becomes “L”. And then, when  $V_{CC}$  supply voltage is higher than UV reset voltage, input signal ( $L_{IN}$ ) is “L”; output signal  $H_O$  becomes “H”.

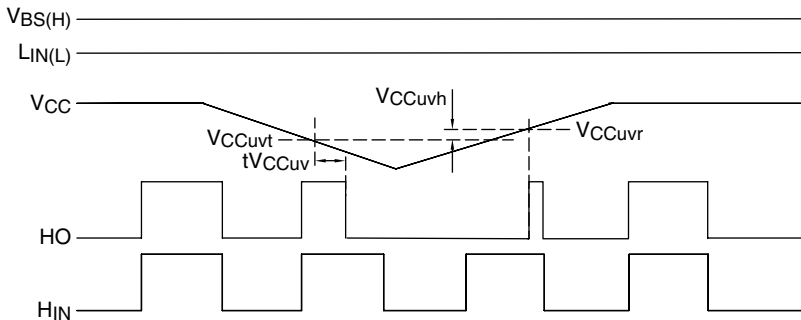

When  $V_{BS}$  supply voltage keeps lower UV trip voltage ( $V_{BSuvt} = V_{BSuvr} - V_{BSuvh}$ ) for  $V_{BS}$  supply UV filter time, output signal becomes “L”. And then,  $V_{BS}$  supply voltage is higher than UV reset voltage, output signal  $H_O$  keeps “L” until next input signal  $H_{IN}$  is “H”.

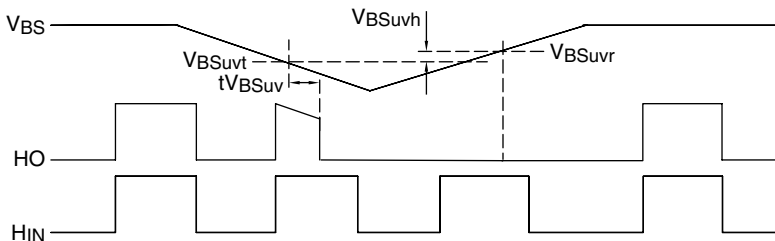

**3. Allowable Supply Voltage Transient**

It is recommended supplying  $V_{CC}$  first and supplying  $V_{BS}$  second. In the case of shutting off supply voltage, shut off  $V_{BS}$  firstly and shut off  $V_{CC}$  second. At the time of starting  $V_{CC}$  and  $V_{BS}$ , power supply should be increased slowly. If it is increased rapidly, output signal ( $H_O$  or  $L_O$ ) may be “H”.