



Features

- Low capacitance
- Performance stability over life
- High insulation resistance
-  UL 1449 4th Edition
- RoHS compliant*

Applications

- DC power supply protection (48 V)

2033 Series Gas Discharge Tube Surge Protector

The Bourns® Model 2033 Series is a 2-electrode 5-stack GDT surge arrester device designed for use with DC power supplies. The series is high current rated with low capacitance and allows for reset of the arrester without use of external components.

Characteristics

Test Methods per ITU-T (CCITT) K.12 and IEEE C62.31

Characteristic	Model No.	
	2033-80	2033-140
DC Sparkover $\pm 30\%$ @ 100 V/s	800 V	1400 V
Impulse Sparkover 1.2/50 μ s, 6 kV	< 2000 V	< 2300 V
Impulse Sparkover 1.2/50 μ s, 6 kV See Figure 1, C1-C4 100 pF	< 900 V	< 950 V

Additional Information

Click these links for more information:



[PRODUCT SELECTOR](#) [TECHNICAL LIBRARY](#) [INVENTORY](#) [SAMPLES](#) [CONTACT](#)

Agency Recognition

Agency	Standard	Agency File No.
	1449 - 4th Ed., Type 1	E313168

Insulation Resistance (IR)	100 VDC	> 10 G Ω
DC Operating Voltage (1)		60 V $\pm 20\%$
Glow Voltage	10 mA	~ 500 V
Arc Voltage	1 A	~ 100 V
Glow-Arc Transition Current		< 1 A
Capacitance	1 MHz	< 1 pF
Impulse Discharge Current	20 kA, 8/20 μ s	10 operations
	100 A, 8/20 μ s	300 operations
	4 kA, 10/350 μ s	± 5 operations
Operating & Storage Temperature		-40 °C to +125 °C
Climatic Category (IEC 60068-1)		40 / 125 / 21
Moisture Sensitivity Level		1
ESD Classification (HBM)		6

Notes:



(1) DC current source 30 A max.

- At delivery AQL 0.65 Level II, DIN ISO 2859.
- Bourns recommends reflowing surface mount devices per IPC/JEDEC J-STD-020 rev. D

How to Order

	2033 - xx - G5 - xx LF
Model Number Designator _____	
Voltage (Divided by 10) _____	
80 = 800 V	
140 = 1400 V	
Number of Gas Chambers _____	
G5 = Five Chambers	
Packaging _____	
Blank = Bulk	
T1 = Tape and Reel	
RoHS Compliancy _____	
LF = RoHS Compliant Product	

Typical Part Marking

2033-80-G5-LF	 80 2033
2033-140-G5-LF	 140 2033

BOURNS®

Asia-Pacific: Tel: +886-2 2562-4117 • Email: asiacus@bourns.com

EMEA: Tel: +36 88 885 877 • Email: eurocus@bourns.com

The Americas: Tel: +1-951 781-5500 • Email: americus@bourns.com

www.bourns.com



WARNING
Cancer and Reproductive Harm
www.P65Warnings.ca.gov

*RoHS Directive 2015/863, Mar 31, 2015 and Annex.

Specifications are subject to change without notice.

Users should verify actual device performance in their specific applications.

The products described herein and this document are subject to specific legal disclaimers as set forth on the last page of this document, and at www.bourns.com/docs/legal/disclaimer.pdf.

Optimizing Model 2033 Series Stacked GDT Turn-on Performance

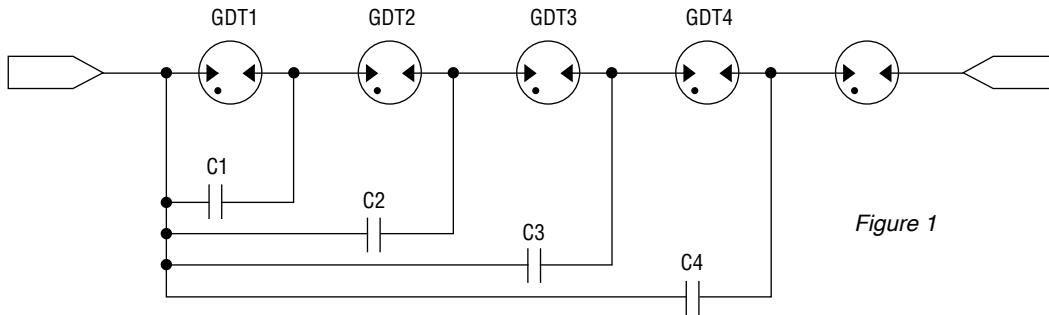

Figure 1

Application

In high current 48 Vdc supply applications, multiple GDTs are required to be connected in series so that the sum of the arc voltages exceed the dc supply voltage. The combined arc voltages of the stacked GDT (typically $12\text{ V} \times 5 = 60\text{ V}$) exceed the 48 Vdc supply which is then not capable of providing enough current to maintain the GDT in an on-state of operation. A stacked GDT design allows for proper reset of the GDT after a transient event.

The downside of a stacked design is that the summation of the individual GDT chamber sparkover voltages results in a device with a high impulse sparkover voltage. For example, if each chamber of the stacked GDT had an impulse sparkover voltage of 400 V, the total impulse sparkover for the entire GDT would be $5 \times 400\text{ V} (2000\text{ V})$. In many cases, this higher sparkover voltage can have a negative impact to downstream components if their voltage sensitivity is less than the impulse sparkover of the stacked GDT.

Solution

High impulse sparkover can be improved by utilizing decoupling capacitors across 4 of 5 individual chambers of the stacked GDT. Typical capacitor values can range from 100 pF to 1 nF.

How it Works

In its initial state, all component values are zero. Under a fast rising voltage ramp condition, there is a capacitive voltage division across GDT1 and C1. During the voltage ramp, most of the voltage appears across GDT1. When the voltage across GDT1 reaches its sparkover voltage (400 V), the voltage across GDT1 drops to its arc voltage which is typically around 12 V.

As a result, the capacitor is charged to a value equaling the sparkover voltage less the arc voltage (example: $400\text{ V} - 12\text{ V} = 388\text{ V}$) which is then applied to GDT2. When GDT2 reaches 400 V, it then attains sparkover and the process repeats itself until GDT5 finally attains sparkover. This cascading turn-on mechanism of the capacitively coupled GDT chambers result in a significantly improved impulse sparkover voltage.

Results

In the table below, both 800 V and 1400 V stacked GDTs were compared using a $5\text{ kV}/\mu\text{s}$ voltage ramp. ITU K.12 recommends using a linear ramp as the best method for evaluating GDT impulse sparkover under fast rising voltage conditions. Impulse sparkover voltage limiting is significantly improved versus using the stacked GDT discretely. It should be noted that there is some improvement in impulse limiting by using a larger capacitor (1 nF). However, the improvement in impulse limiting must be measured against the cost of using a larger capacitor.

C1-C4 Capacitor Values	Model 2033-80 Typical Impulse Sparkover @ $5\text{ kV}/\mu\text{s}$	Model 2033-140 Typical Impulse Sparkover @ $5\text{ kV}/\mu\text{s}$
No Capacitor	2200 V	2400 V
100 pF	700 V	988 V
1 nF	600 V	886 V

NOTE: Impulse sparkover in the characteristic table on Page 1 is shown under combination wave conditions ($8/20\ \mu\text{s}$ current/ $1.2 \times 50\ \mu\text{s}$ voltage). This non-linear voltage condition will give results different than under a linear ramp speed. The typical values in the table above will differ.

Specifications are subject to change without notice.

Users should verify actual device performance in their specific applications.

The products described herein and this document are subject to specific legal disclaimers as set forth on the last page of this document, and at www.bourns.com/docs/legal/disclaimer.pdf.

2033 Series Gas Discharge Tube Surge Protector

BOURNS®

Product Dimensions

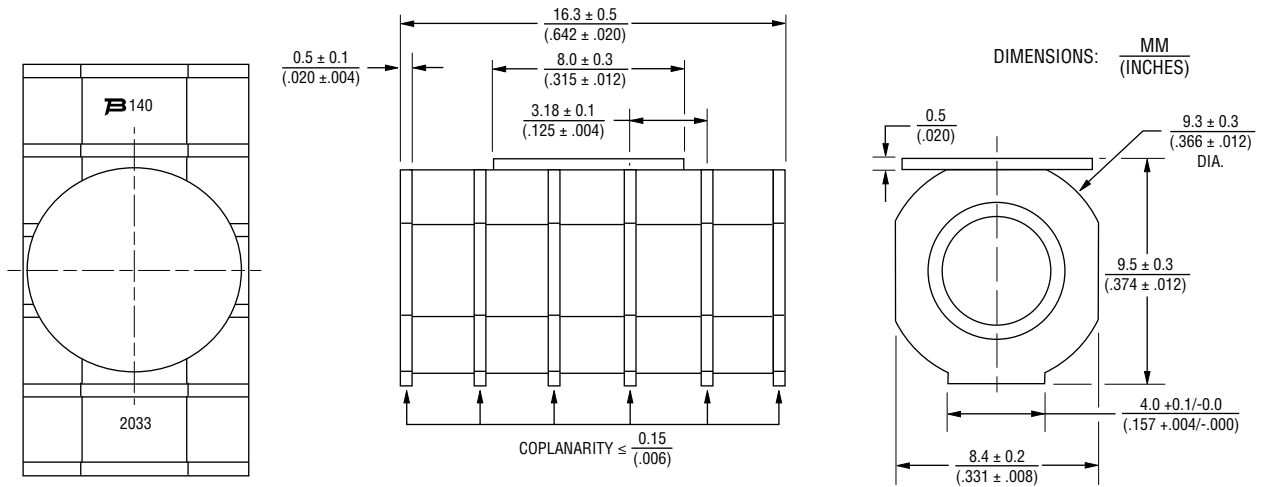

Recommended Pad Layout

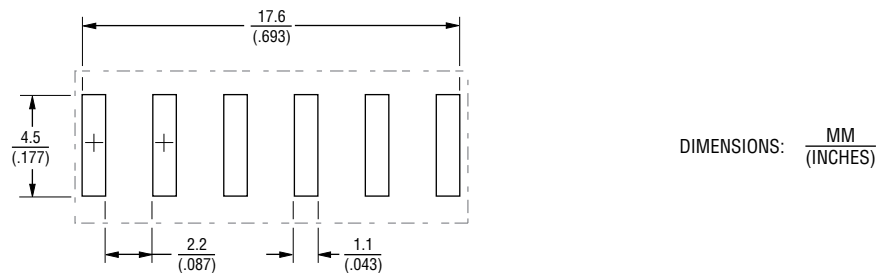

Packaging Specifications

The Model 2033-xx-G5 ships standard bulk, 100 pieces per plastic tray, 500 pieces per box.

Tape and Reel option available; 250 pieces per 13-inch reel.

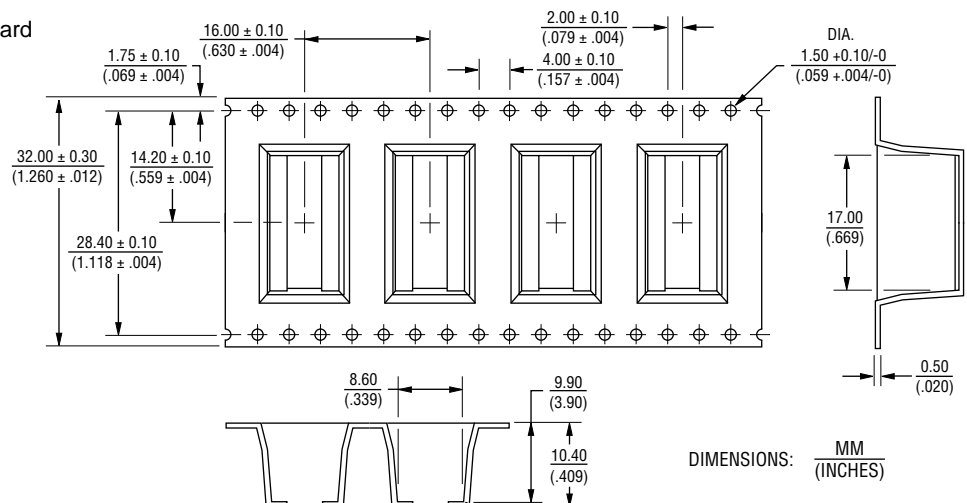

REV. A 12/19

Specifications are subject to change without notice.

Users should verify actual device performance in their specific applications.

The products described herein and this document are subject to specific legal disclaimers as set forth on the last page of this document, and at www.bourns.com/docs/legal/disclaimer.pdf.

This legal disclaimer applies to purchasers and users of Bourns® products manufactured by or on behalf of Bourns, Inc. and its affiliates (collectively, “Bourns”).

Unless otherwise expressly indicated in writing, Bourns® products and data sheets relating thereto are subject to change without notice. Users should check for and obtain the latest relevant information and verify that such information is current and complete before placing orders for Bourns® products.

The characteristics and parameters of a Bourns® product set forth in its data sheet are based on laboratory conditions, and statements regarding the suitability of products for certain types of applications are based on Bourns’ knowledge of typical requirements in generic applications. The characteristics and parameters of a Bourns® product in a user application may vary from the data sheet characteristics and parameters due to (i) the combination of the Bourns® product with other components in the user’s application, or (ii) the environment of the user application itself. The characteristics and parameters of a Bourns® product also can and do vary in different applications and actual performance may vary over time. Users should always verify the actual performance of the Bourns® product in their specific devices and applications, and make their own independent judgments regarding the amount of additional test margin to design into their device or application to compensate for differences between laboratory and real world conditions.

Unless Bourns has explicitly designated an individual Bourns® product as meeting the requirements of a particular industry standard (e.g., ISO/TS 16949) or a particular qualification (e.g., UL listed or recognized), Bourns is not responsible for any failure of an individual Bourns® product to meet the requirements of such industry standard or particular qualification. Users of Bourns® products are responsible for ensuring compliance with safety-related requirements and standards applicable to their devices or applications.

Bourns® products are not recommended, authorized or intended for use in nuclear, lifesaving, life-critical or life-sustaining applications, nor in any other applications where failure or malfunction may result in personal injury, death, or severe property or environmental damage. Unless expressly and specifically approved in writing by two authorized Bourns representatives on a case-by-case basis, use of any Bourns® products in such unauthorized applications might not be safe and thus is at the user’s sole risk. Life-critical applications include devices identified by the U.S. Food and Drug Administration as Class III devices and generally equivalent classifications outside of the United States.

Bourns expressly identifies those Bourns® standard products that are suitable for use in automotive applications on such products’ data sheets in the section entitled “Applications.” Unless expressly and specifically approved in writing by two authorized Bourns representatives on a case-by-case basis, use of any other Bourns® standard products in an automotive application might not be safe and thus is not recommended, authorized or intended and is at the user’s sole risk. If Bourns expressly identifies a sub-category of automotive application in the data sheet for its standard products (such as infotainment or lighting), such identification means that Bourns has reviewed its standard product and has determined that if such Bourns® standard product is considered for potential use in automotive applications, it should only be used in such sub-category of automotive applications. Any reference to Bourns® standard product in the data sheet as compliant with the AEC-Q standard or “automotive grade” does not by itself mean that Bourns has approved such product for use in an automotive application.

Bourns® standard products are not tested to comply with United States Federal Aviation Administration standards generally or any other generally equivalent governmental organization standard applicable to products designed or manufactured for use in aircraft or space applications. Bourns expressly identifies Bourns® standard products that are suitable for use in aircraft or space applications on such products’ data sheets in the section entitled “Applications.” Unless expressly and specifically approved in writing by two authorized Bourns representatives on a case-by-case basis, use of any other Bourns® standard product in an aircraft or space application might not be safe and thus is not recommended, authorized or intended and is at the user’s sole risk.

The use and level of testing applicable to Bourns® custom products shall be negotiated on a case-by-case basis by Bourns and the user for which such Bourns® custom products are specially designed. Absent a written agreement between Bourns and the user regarding the use and level of such testing, the above provisions applicable to Bourns® standard products shall also apply to such Bourns® custom products.

Users shall not sell, transfer, export or re-export any Bourns® products or technology for use in activities which involve the design, development, production, use or stockpiling of nuclear, chemical or biological weapons or missiles, nor shall they use Bourns® products or technology in any facility which engages in activities relating to such devices. The foregoing restrictions apply to all uses and applications that violate national or international prohibitions, including embargos or international regulations. Further, Bourns® products and Bourns technology and technical data may not under any circumstance be exported or re-exported to countries subject to international sanctions or embargoes. Bourns® products may not, without prior authorization from Bourns and/or the U.S. Government, be resold, transferred, or re-exported to any party not eligible to receive U.S. commodities, software, and technical data.

To the maximum extent permitted by applicable law, Bourns disclaims (i) any and all liability for special, punitive, consequential, incidental or indirect damages or lost revenues or lost profits, and (ii) any and all implied warranties, including implied warranties of fitness for particular purpose, non-infringement and merchantability.

For your convenience, copies of this Legal Disclaimer Notice with German, Spanish, Japanese, Traditional Chinese and Simplified Chinese bilingual versions are available at:

Web Page: <http://www.bourns.com/legal/disclaimers-terms-and-policies>

PDF: <http://www.bourns.com/docs/Legal/disclaimer.pdf>