

Features

- No load capacitors required
- No motional series resistance (ESR) compensation
- No negative resistance testing
- Guaranteed oscillator startup under all conditions
- One active resonator can drive up to two clock inputs
- All-inclusive frequency stability as low as ± 20 ppm over extended temperature range (-55°C to 125°C)
- Fundamental frequencies between 1 MHz and 110 MHz accurate to 6 decimal places
- Supply voltage of 1.8 V or 2.25 V to 3.63 V
- Industry best G-sensitivity of 0.1 ppb/g
- Low power consumption of 3.8 mA typical at 1.8 V
- LVCMOS compatible output
- Industry-standard packages: 2.5 x 2.0, 3.2 x 2.5 mm x mm
- RoHS and REACH compliant, Pb-free, Halogen-free and Antimony-free

Conditions for Drop-In-Replacement

- SiT1424 is designed to work with non-wireless MCUs except for BLE which is supported
- SiT1424 is footprint compatible to 4-pad SMD Xtal resonators with electrically grounded pin 2 and 4
- MCU/ μ C supports external oscillator mode
- MCU/ μ C supports GPIO output function on XTAL1 pin (Figure 18) and able to drive ~6 mA across 1.8 V to 3.3 V VDD continuous voltage

Applications

- Automotive, extreme temperature and other high-rel electronics
- Infotainment systems, collision detection devices, and in-vehicle networking
- Powertrain control



Electrical Characteristics

Table 1. Electrical Characteristics^[1,2]

All Min and Max limits are specified over temperature and rated operating voltage with 15 pF output load unless otherwise stated. Typical values are at 25°C and nominal supply voltage.

Parameters	Symbol	Min.	Typ.	Max.	Unit	Condition
Frequency Range						
Output Frequency Range	f	1	–	110	MHz	Refer to Table 3 to 5 for a list of supported frequencies
Frequency Stability and Aging						
Frequency Stability	F _{stab}	-15	–	+15	ppm	At 25°C
		-20	–	+20	ppm	Inclusive of Initial tolerance at 25°C, 1st year aging at 25°C, and variations over operating temperature, rated power supply voltage and load
		-25	–	+25	ppm	
		-30	–	+30	ppm	
		-50	–	+50	ppm	
Operating Temperature Range						
Operating Temperature Range	T _{use}	-40	–	+85	°C	AEC-Q100 Grade3
		-40	–	+105	°C	AEC-Q100 Grade2
		-40	–	+125	°C	AEC-Q100 Grade 1
		-40	–	+150	°C	AEC-Q100 Grade 0 (Contact SiTime)
		-55	–	+125	°C	Extended cold AEC-Q100 Grade1
Supply Voltage and Current Consumption						
Supply Voltage	V _{dd}	1.62	1.8	1.98	V	All voltages between 2.25 V and 3.63 V including 2.5 V, 2.8 V, 3.0 V and 3.3 V are supported
		2.25	–	3.63	V	
Current Consumption	I _{dd}	–	4.0	4.8	mA	No load condition, f = 20 MHz, V _{dd} = 2.25 V to 3.63 V
		–	3.8	4.5	mA	No load condition, f = 20 MHz, V _{dd} = 1.8 V

Table 1. Electrical Characteristics^[1,2] (continued)

Parameters	Symbol	Min.	Typ.	Max.	Unit	Condition
LVC MOS Output Characteristics						
Duty Cycle	DC	45	–	55	%	All Vdd levels
Rise/Fall Time	Tr, Tf	–	1.5	3	ns	Vdd = 2.25 V - 3.63 V, 20% - 80%
		–	1.3	2.5	ns	Vdd = 1.8 V, 20% - 80%
Output High Voltage	VOH	90%	–	–	Vdd	IOH = -4 mA (Vdd = 3.0 V or 3.3 V) IOH = -3 mA (Vdd = 2.8 V and Vdd = 2.5 V) IOH = -2 mA (Vdd = 1.8 V)
Output Low Voltage	VOL	–	–	10%	Vdd	IOL = 4 mA (Vdd = 3.0 V or 3.3 V) IOL = 3 mA (Vdd = 2.8 V and Vdd = 2.5 V) IOL = 2 mA (Vdd = 1.8 V)
Startup Timing						
Startup Time	T_start	–	–	5.5	ms	Measured from the time Vdd reaches its rated minimum value
Jitter						
RMS Period Jitter	T_jitt	–	1.6	2.5	ps	f = 75 MHz, 2.25 V to 3.63 V
		–	1.9	3.0	ps	f = 75 MHz, 1.8 V
RMS Phase Jitter (random)	T_phj	–	0.5	–	ps	f = 75 MHz, Integration bandwidth = 900 kHz to 7.5 MHz
		–	1.3	–	ps	f = 75 MHz, Integration bandwidth = 12 kHz to 20 MHz

Notes:

- All electrical specifications in the above table are specified with 15 pF output load and for all Vdd(s) unless otherwise stated.
- The typical value of any parameter in the Electrical Characteristic table is specified for the nominal value of the highest voltage option for that parameter and at 25°C temperature.

Table 2. Pin Description

Pin	Symbol	Functionality
1	XIN/VDD	VDD Power Connect to μ C GPIO pin XTAL1 set High via firmware ^[9]
2	GND	Power Electrical ground
3	XOUT/CLK	Output CLK output; connect to μ C XTAL2 pin (refer to Figure 18 in Application Note section)
4	GND	Power Electrical GND

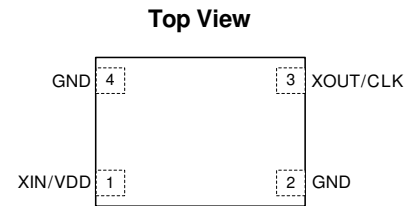

Figure 1. Pin Assignments

Notes:

- A capacitor of value 4.7 nF between XIN and ground is recommended (Please refer to the [Application Note](#) section).

Ordering Information

The following part number guide is for reference only.

To customize and build an exact part number, use the [SiTime Part Number Generator](#).

SiT1424BA-12-18N-66.666666D

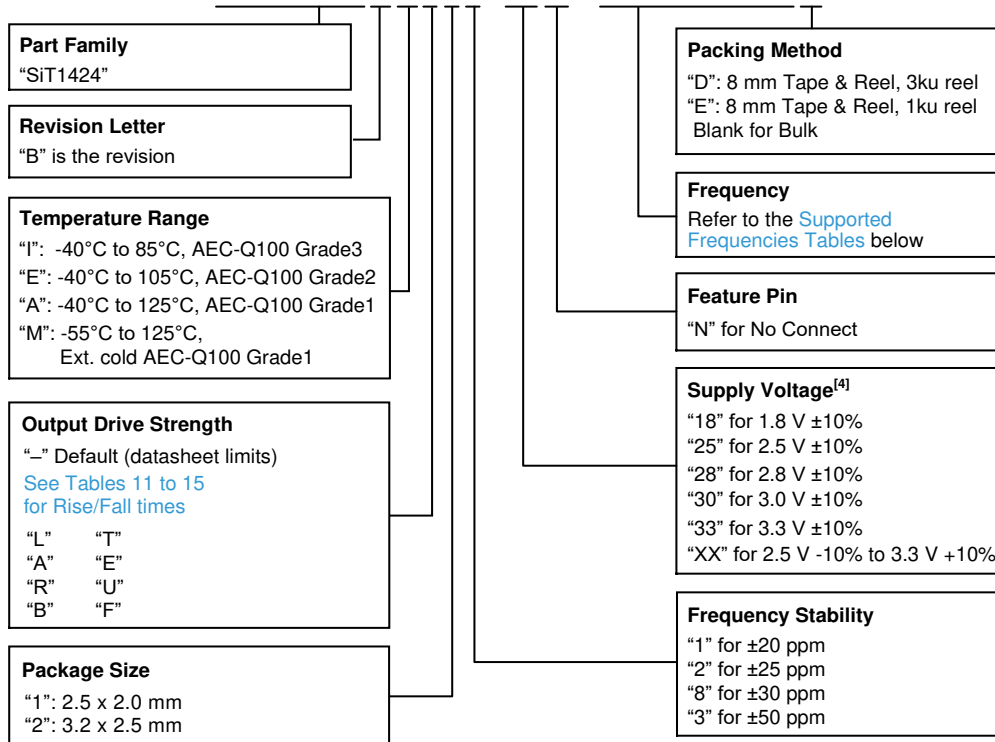

Note:

- The voltage portion of the SiT1424 part number consists of two characters that denote the specific supply voltage of the device. The SiT1424 supports either 1.8 V ±10% or any voltage between 2.25 V and 3.62 V. In the 1.8 V mode, one can simply insert 18 in the part number. In the 2.5 V to 3.3 V mode, two digits such as 18, 25 or 33 can be used in the part number to reflect the desired voltage. Alternatively, "XX" can be used to indicate the entire operating voltage range from 2.25 V to 3.63 V.

Table 3. Supported Frequencies (-40°C to +85°C)^[5]

Frequency Range	
Min.	Max.
1.000000 MHz	110.000000 MHz

Table 4. Supported Frequencies (-40°C to +105°C or -40°C to +125°C) ^[5,3]

Frequency Range	
Min.	Max.
1.000000 MHz	61.222999 MHz
61.974001 MHz	69.795999 MHz
70.485001 MHz	79.062999 MHz
79.162001 MHz	81.427999 MHz
82.232001 MHz	91.833999 MHz
92.155001 MHz	94.248999 MHz
94.430001 MHz	94.874999 MHz
94.994001 MHz	97.713999 MHz
98.679001 MHz	110.000000 MHz

Table 5. Supported Frequencies (-55°C to +125°C) ^[5,3]

Frequency Range	
Min.	Max.
1.000000 MHz	61.222999 MHz
61.974001 MHz	69.239999 MHz
70.827001 MHz	78.714999 MHz
79.561001 MHz	80.159999 MHz
80.174001 MHz	80.779999 MHz
82.632001 MHz	91.833999 MHz
95.474001 MHz	96.191999 MHz
96.209001 MHz	96.935999 MHz
99.158001 MHz	110.000000 MHz

Notes:

- Any frequency within the min and max values in the above tables are supported with 6 decimal places of accuracy.
- Please [contact SiTime](#) for frequencies that are not listed in the tables above.

Table 6. Ordering Codes for Supported Tape & Reel Packing Method

Device Size (mm x mm)	16 mm T&R (3ku)	16 mm T&R (1ku)	12 mm T&R (3ku)	12 mm T&R (1ku)	8 mm T&R (3ku)	8 mm T&R (1ku)
2.5 x 2.0	–	–	–	–	D	E
3.2 x 2.5	–	–	–	–	D	E

Table 7. Absolute Maximum Limits

Attempted operation outside the absolute maximum ratings may cause permanent damage to the part. Actual performance of the IC is only guaranteed within the operational specifications, not at absolute maximum ratings.

Parameter	Min.	Max.	Unit
Storage Temperature	-65	150	°C
Vdd	-0.5	4	V
Electrostatic Discharge	–	2000	V
Soldering Temperature (follow standard Pb free soldering guidelines)	–	260	°C
Junction Temperature ^[7]	–	150	°C

Note:

7. Exceeding this temperature for extended period of time may damage the device. Pls contact SiTime for Junction Temperature above 150°C

Table 8. Thermal Consideration^[8]

Package	θ_{JA} , 4 Layer Board (°C/W)	θ_{JA} , 2 Layer Board (°C/W)	θ_{JC} , Bottom (°C/W)
3225	109	212	27
2520	117	222	26

Note:

8. Refer to JESD51 for θ_{JA} and θ_{JC} definitions, and reference layout used to determine the θ_{JA} and θ_{JC} values in the above table.

Table 9. Maximum Operating Junction Temperature^[9]

Max Operating Temperature (ambient)	Maximum Operating Junction Temperature
85°C	95°C
105°C	115°C
125°C	135°C
150°C	Contact SiTime

Note:

9. Datasheet specifications are not guaranteed if junction temperature exceeds the maximum operating junction temperature.

Table 10. Environmental Compliance

Parameter	Condition/Test Method
Mechanical Shock	MIL-STD-883F, Method 2002
Mechanical Vibration	MIL-STD-883F, Method 2007
Temperature Cycle	JESD22, Method A104
Solderability	MIL-STD-883F, Method 2003
Moisture Sensitivity Level	MSL1 @ 260°C

Test Circuit and Waveform

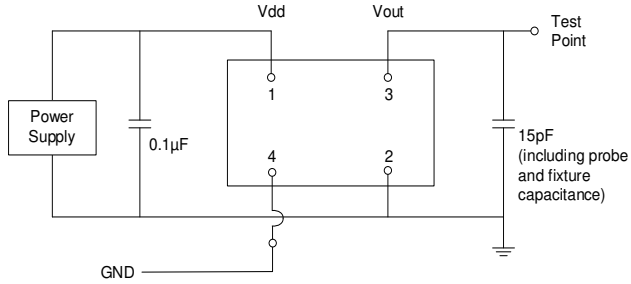

Figure 2. Test Circuit^[10]

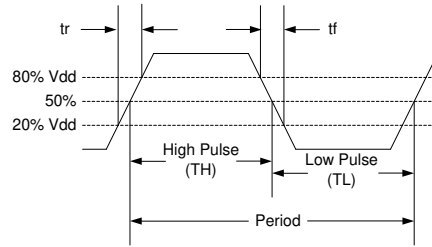
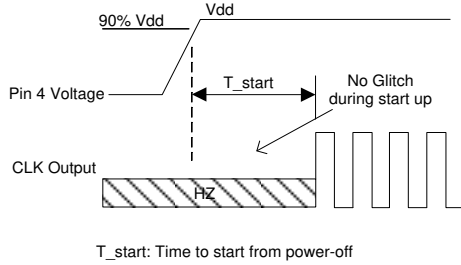

Figure 3. Waveform^[10]

Note:

10. Duty Cycle is computed as $Duty\ Cycle = TH/Period$.

Timing Diagrams



T_start: Time to start from power-off

Figure 4. Startup Timing^[11]

Note:

11. SiT1424 has “no runt” pulses and “no glitch” output during startup or resume.

Performance Plots^[12]

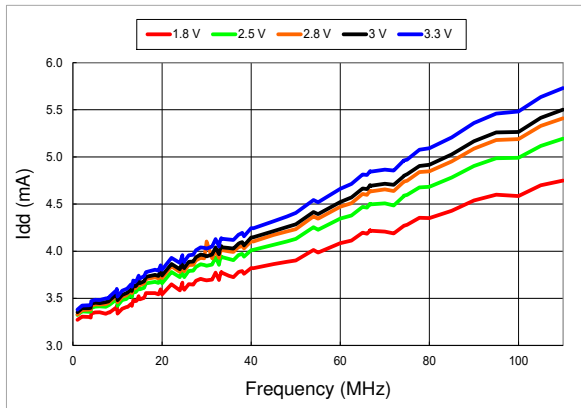

Figure 5. Idd vs Frequency

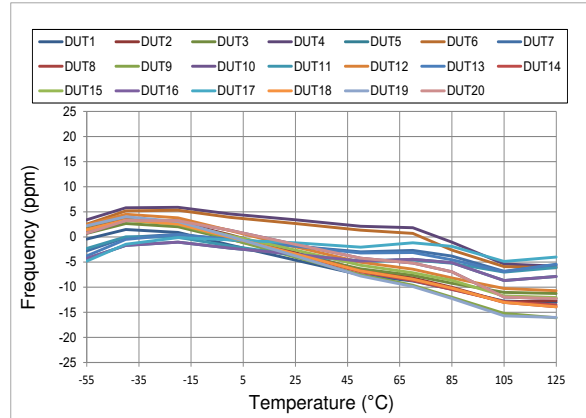

Figure 6. Frequency vs Temperature

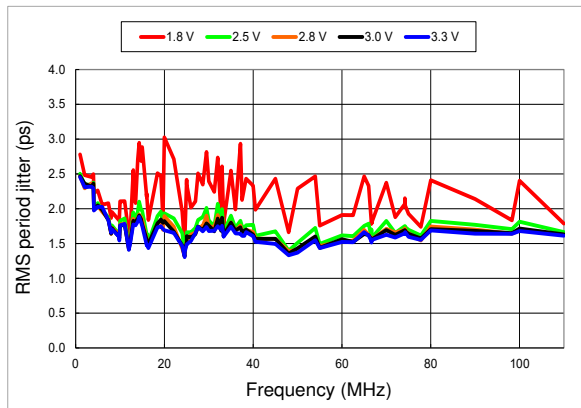

Figure 7. RMS Period Jitter vs Frequency

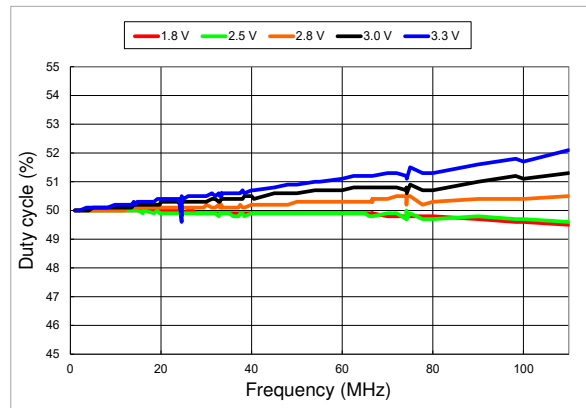

Figure 8. Duty Cycle vs Frequency

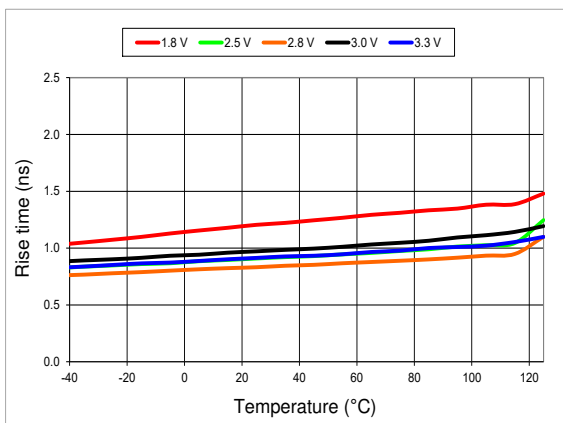

Figure 9. 20%-80% Rise Time vs Temperature

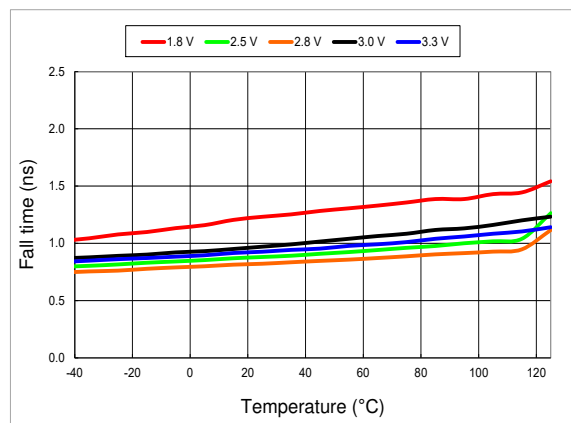

Figure 10. 20%-80% Fall Time vs Temperature

Performance Plots^[12]

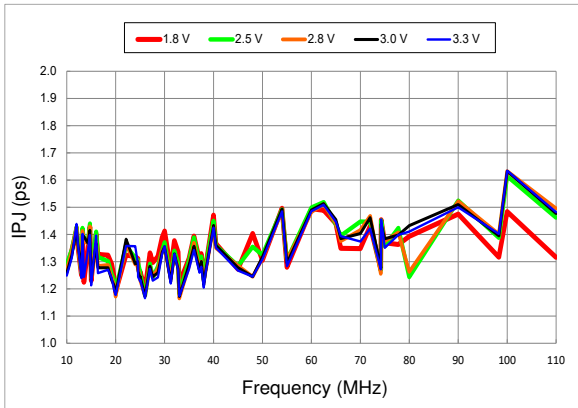

Figure 11. RMS Integrated Phase Jitter Random (12 kHz to 20 MHz) vs Frequency^[13]

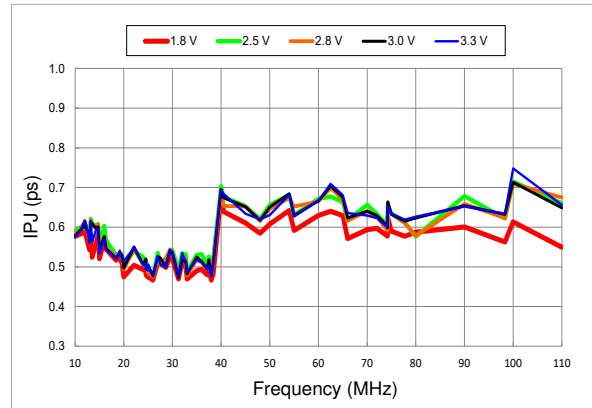

Figure 12. RMS Integrated Phase Jitter Random (900 kHz to 20 MHz) vs Frequency^[13]

Notes:

- 12. All plots are measured with 15 pF load at room temperature, unless otherwise stated.
- 13. Phase noise plots are measured with Agilent E5052B signal source analyzer. Integration range is up to 5 MHz for carrier frequencies up to 40 MHz.

Programmable Drive Strength

The SiT1424 XCalibur™ active resonator includes a programmable drive strength feature to provide a simple, flexible tool to optimize the clock rise/fall time for specific applications. Benefits from the programmable drive strength feature are:

- Improves system radiated electromagnetic interference (EMI) by slowing down the clock rise/fall time.
- Improves the downstream clock receiver's (RX) jitter by decreasing (speeding up) the clock rise/fall time.
- Ability to drive large capacitive loads while maintaining full swing with sharp edge rates.

For more detailed information about rise/fall time control and drive strength selection, see the [SiTime Application Notes](#) section.

EMI Reduction by Slowing Rise/Fall Time

Figure 13 shows the harmonic power reduction as the rise/fall times are increased (slowed down). The rise/fall times are expressed as a ratio of the clock period. For the ratio of 0.05, the signal is very close to a square wave. For the ratio of 0.45, the rise/fall times are very close to near-triangular waveform. These results, for example, show that the 11th clock harmonic can be reduced by 35 dB if the rise/fall edge is increased from 5% of the period to 45% of the period.

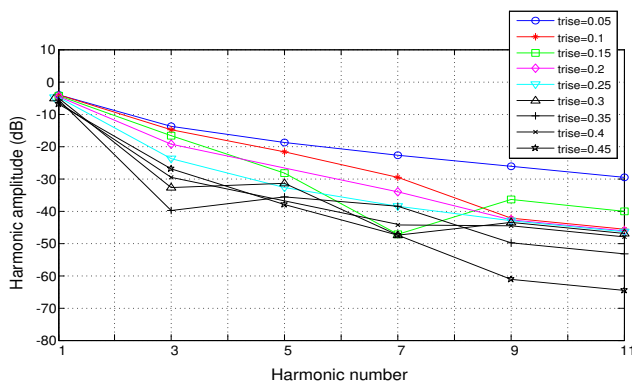

Figure 13. Harmonic EMI reduction as a Function of Slower Rise/Fall Time

Jitter Reduction with Faster Rise/Fall Time

Power supply noise can be a source of jitter for the downstream chipset. One way to reduce this jitter is to speed up the rise/fall time of the input clock. Some chipsets may also require faster rise/fall time in order to reduce their sensitivity to this type of jitter. Refer to the [Rise/Fall Time Tables \(Table 11 to Table 15\)](#) to determine the proper drive strength.

High Output Load Capability

The rise/fall time of the input clock varies as a function of the actual capacitive load the clock drives. At any given drive strength, the rise/fall time becomes slower as the output load increases. As an example, for a 3.3V SiT1424 device with default drive strength setting, the typical rise/fall time is 1 ns for 15 pF output load. The typical rise/fall time slows down to 2.6 ns when the output load increases to 45 pF.

One can choose to speed up the rise/fall time to 1.83 ns by then increasing the drive strength setting on the SiT1424.

The SiT1424 can support up to 60 pF in maximum capacitive loads with drive strength settings. Refer to the [Rise/Fall Time Tables \(Table 11 to Table 15\)](#) to determine the proper drive strength for the desired combination of output load vs. rise/fall time.

SiT1424 Drive Strength Selection

Tables 11 through 15 define the rise/fall time for a given capacitive load and supply voltage.

- Select the table that matches the SiT1424 nominal supply voltage (1.8 V, 2.5 V, 2.8 V, 3.0 V, 3.3 V).
- Select the capacitive load column that matches the application requirement (5 pF to 60 pF)
- Under the capacitive load column, select the desired rise/fall times.
- The left-most column represents the part number code for the corresponding drive strength.
- Add the drive strength code to the part number for ordering purposes.

Calculating Maximum Frequency

Based on the rise and fall time data given in Tables 11 through 15, the maximum frequency the oscillator can operate with guaranteed full swing of the output voltage over temperature can be calculated as follows:

$$\text{Max Frequency} = \frac{1}{5 \times \text{Trf}_{20/80}}$$

where $\text{Trf}_{20/80}$ is the typical value for 20%-80% rise/fall time.

Example 1

Calculate f_{MAX} for the following condition:

- Vdd = 1.8 V ([Table 11](#))
- Capacitive Load: 30 pF
- Desired Tr/f time = 3 ns (rise/fall time part number code = E)

Part number for the above example:

SiT1424BIE12-18E-66.666660



Drive strength code is inserted here. Default setting is “-”

Rise/Fall Time (20% to 80%) vs C_{LOAD} Tables

Table 11. V_{dd} = 1.8 V Rise/Fall Times for Specific C_{LOAD}

Rise/Fall Time Typ (ns)					
Drive Strength \ C _{LOAD}	5 pF	15 pF	30 pF	45 pF	60 pF
L	6.16	11.61	22.00	31.27	39.91
A	3.19	6.35	11.00	16.01	21.52
R	2.11	4.31	7.65	10.77	14.47
B	1.65	3.23	5.79	8.18	11.08
T	0.93	1.91	3.32	4.66	6.48
E	0.78	1.66	2.94	4.09	5.74
U	0.70	1.48	2.64	3.68	5.09
F or "-": default	0.65	1.30	2.40	3.35	4.56

Table 12. V_{dd} = 2.5 V Rise/Fall Times for Specific C_{LOAD}

Rise/Fall Time Typ (ns)					
Drive Strength \ C _{LOAD}	5 pF	15 pF	30 pF	45 pF	60 pF
L	4.13	8.25	12.82	21.45	27.79
A	2.11	4.27	7.64	11.20	14.49
R	1.45	2.81	5.16	7.65	9.88
B	1.09	2.20	3.88	5.86	7.57
T	0.62	1.28	2.27	3.51	4.45
E or "-": default	0.54	1.00	2.01	3.10	4.01
U	0.43	0.96	1.81	2.79	3.65
F	0.34	0.88	1.64	2.54	3.32

Table 13. V_{dd} = 2.8 V Rise/Fall Times for Specific C_{LOAD}

Rise/Fall Time Typ (ns)					
Drive Strength \ C _{LOAD}	5 pF	15 pF	30 pF	45 pF	60 pF
L	3.77	7.54	12.28	19.57	25.27
A	1.94	3.90	7.03	10.24	13.34
R	1.29	2.57	4.72	7.01	9.06
B	0.97	2.00	3.54	5.43	6.93
T	0.55	1.12	2.08	3.22	4.08
E or "-": default	0.44	1.00	1.83	2.82	3.67
U	0.34	0.88	1.64	2.52	3.30
F	0.29	0.81	1.48	2.29	2.99

Table 14. V_{dd} = 3.0 V Rise/Fall Times for Specific C_{LOAD}

Rise/Fall Time Typ (ns)					
Drive Strength \ C _{LOAD}	5 pF	15 pF	30 pF	45 pF	60 pF
L	3.60	7.21	11.97	18.74	24.30
A	1.84	3.71	6.72	9.86	12.68
R	1.22	2.46	4.54	6.76	8.62
B	0.89	1.92	3.39	5.20	6.64
T or "-": default	0.51	1.00	1.97	3.07	3.90
E	0.38	0.92	1.72	2.71	3.51
U	0.30	0.83	1.55	2.40	3.13
F	0.27	0.76	1.39	2.16	2.85

Table 15. V_{dd} = 3.3 V Rise/Fall Times for Specific C_{LOAD}

Rise/Fall Time Typ (ns)					
Drive Strength \ C _{LOAD}	5 pF	15 pF	30 pF	45 pF	60 pF
L	3.39	6.88	11.63	17.56	23.59
A	1.74	3.50	6.38	8.98	12.19
R	1.16	2.33	4.29	6.04	8.34
B	0.81	1.82	3.22	4.52	6.33
T or "-": default	0.46	1.00	1.86	2.60	3.84
E	0.33	0.87	1.64	2.30	3.35
U	0.28	0.79	1.46	2.05	2.93
F	0.25	0.72	1.31	1.83	2.61

Output on Startup

The SiT1424 XCalibur™ active resonator comes with gated output. Its clock output is accurate to the rated frequency stability within the first pulse from initial device startup. In addition, the SiT1424 features “no runt” pulses and “no glitch” output during startup as shown in the waveform captures in [Figure 14](#) and [Figure 15](#).

Instant Samples with Time Machine and Field Programmable Active Resonator

SiTime supports a field programmable version of the SiT1424 for fast prototyping and real time customization of features. The field programmable devices (FP devices) are available for all three standard SiT1424 package sizes and can be configured to one’s exact specification using the Time Machine II, an USB powered MEMS resonator programmer. For more information regarding SiTime’s field programmable solutions, see [Time Machine II](#) and [Field Programmable Devices](#). SiT1424 is typically factory-programmed per customer ordering codes for volume delivery.



Figure 14. Startup Waveform vs. Vdd

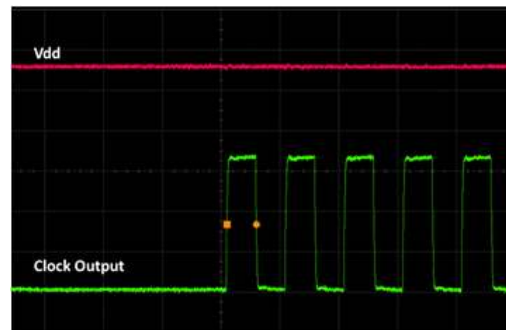

**Figure 15. Startup Waveform vs. Vdd
(Zoomed-in View of [Figure 14](#))**

Dimensions and Patterns

Package Size – Dimensions (Unit: mm) ^[14]	Recommended Land Pattern (Unit: mm) ^[15]																																																																											
<p>2.5 x 2.0 x 0.75 mm</p> <p>TOP VIEW: Dimensions A, B, D, E. Callouts aaa, c.</p> <p>BOTTOM VIEW: Dimensions L, b, e. Callout (b1).</p> <p>SIDE VIEW: Dimensions A, A1, c. Callouts bbb, c, ccc, c. SEATING PLANE.</p> <table border="1" style="width:100%; border-collapse: collapse; margin-top: 10px;"> <thead> <tr> <th></th> <th>SYMBOL</th> <th>MIN</th> <th>NOM</th> <th>MAX</th> </tr> </thead> <tbody> <tr> <td>TOTAL THICKNESS</td> <td>A</td> <td>0.700</td> <td>0.750</td> <td>0.800</td> </tr> <tr> <td>STAND OFF</td> <td>A1</td> <td>0.000</td> <td>0.020</td> <td>0.050</td> </tr> <tr> <td rowspan="2">BODY SIZE</td> <td>X</td> <td colspan="3">D 2,500 BSC</td> </tr> <tr> <td>Y</td> <td colspan="3">E 2,000 BSC</td> </tr> <tr> <td rowspan="2">LEAD WIDTH</td> <td>b</td> <td>0.300</td> <td>0.350</td> <td>0.400</td> </tr> <tr> <td>b1</td> <td colspan="3">0.500 REF</td> </tr> <tr> <td>LEAD LENGTH</td> <td>L</td> <td>0.650</td> <td>0.750</td> <td>0.850</td> </tr> <tr> <td>LEAD PITCH</td> <td>e</td> <td colspan="3">1,250 BSC</td> </tr> <tr> <td>PACKAGE TOLERANCE</td> <td>aaa</td> <td colspan="3">0.050</td> </tr> <tr> <td>MOLD FLATNESS</td> <td>bbb</td> <td colspan="3">0.100</td> </tr> <tr> <td>COPLANARITY</td> <td>ccc</td> <td colspan="3">0.080</td> </tr> </tbody> </table> <p>NOTE 1. ALL DIMENSION IN MM</p> <div style="text-align: center; margin-top: 10px;"> </div> <table border="1" style="width:100%; border-collapse: collapse; margin-top: 10px;"> <thead> <tr> <th>PKG INFO</th> <th>DRAWING NO.</th> </tr> </thead> <tbody> <tr> <td>4L PQFN 2.500x2.000x0.750 mm</td> <td>POD-010-PQFN-004-X02025</td> </tr> <tr> <td></td> <td>REV</td> </tr> <tr> <td>DATE 31 May 2021</td> <td>B00</td> </tr> </tbody> </table>		SYMBOL	MIN	NOM	MAX	TOTAL THICKNESS	A	0.700	0.750	0.800	STAND OFF	A1	0.000	0.020	0.050	BODY SIZE	X	D 2,500 BSC			Y	E 2,000 BSC			LEAD WIDTH	b	0.300	0.350	0.400	b1	0.500 REF			LEAD LENGTH	L	0.650	0.750	0.850	LEAD PITCH	e	1,250 BSC			PACKAGE TOLERANCE	aaa	0.050			MOLD FLATNESS	bbb	0.100			COPLANARITY	ccc	0.080			PKG INFO	DRAWING NO.	4L PQFN 2.500x2.000x0.750 mm	POD-010-PQFN-004-X02025		REV	DATE 31 May 2021	B00										
	SYMBOL	MIN	NOM	MAX																																																																								
TOTAL THICKNESS	A	0.700	0.750	0.800																																																																								
STAND OFF	A1	0.000	0.020	0.050																																																																								
BODY SIZE	X	D 2,500 BSC																																																																										
	Y	E 2,000 BSC																																																																										
LEAD WIDTH	b	0.300	0.350	0.400																																																																								
	b1	0.500 REF																																																																										
LEAD LENGTH	L	0.650	0.750	0.850																																																																								
LEAD PITCH	e	1,250 BSC																																																																										
PACKAGE TOLERANCE	aaa	0.050																																																																										
MOLD FLATNESS	bbb	0.100																																																																										
COPLANARITY	ccc	0.080																																																																										
PKG INFO	DRAWING NO.																																																																											
4L PQFN 2.500x2.000x0.750 mm	POD-010-PQFN-004-X02025																																																																											
	REV																																																																											
DATE 31 May 2021	B00																																																																											
<p>3.2 x 2.5 x 0.75 mm</p> <p>TOP VIEW: Dimensions A, B, D, E. Callouts aaa, c.</p> <p>BOTTOM VIEW: Dimensions e, L, L1, b, F, F1. Callout (F).</p> <p>SIDE VIEW: Dimensions A, A1, c. Callouts bbb, c, ccc, c. SEATING PLANE.</p> <table border="1" style="width:100%; border-collapse: collapse; margin-top: 10px;"> <thead> <tr> <th></th> <th>SYMBOL</th> <th>MIN</th> <th>NOM</th> <th>MAX</th> </tr> </thead> <tbody> <tr> <td>TOTAL THICKNESS</td> <td>A</td> <td>0.700</td> <td>0.750</td> <td>0.800</td> </tr> <tr> <td>STAND OFF</td> <td>A1</td> <td>0.000</td> <td>0.020</td> <td>0.050</td> </tr> <tr> <td rowspan="2">BODY SIZE</td> <td>X</td> <td colspan="3">D 3,200 BSC</td> </tr> <tr> <td>Y</td> <td colspan="3">E 2,500 BSC</td> </tr> <tr> <td rowspan="2">LEAD WIDTH</td> <td>b</td> <td>0.800</td> <td>0.900</td> <td>1.000</td> </tr> <tr> <td>L</td> <td>0.600</td> <td>0.700</td> <td>0.800</td> </tr> <tr> <td>LEAD LENGTH</td> <td>L1</td> <td>0.700</td> <td>0.800</td> <td>0.900</td> </tr> <tr> <td>LEAD PITCH</td> <td>e</td> <td colspan="3">2,100 BSC</td> </tr> <tr> <td rowspan="2">RADIUS</td> <td>F</td> <td colspan="3">0.450 REF</td> </tr> <tr> <td>F1</td> <td colspan="3">0.200 REF</td> </tr> <tr> <td>PACKAGE TOLERANCE</td> <td>aaa</td> <td colspan="3">0.050</td> </tr> <tr> <td>MOLD FLATNESS</td> <td>bbb</td> <td colspan="3">0.100</td> </tr> <tr> <td>COPLANARITY</td> <td>ccc</td> <td colspan="3">0.080</td> </tr> </tbody> </table> <p>NOTE 1. ALL DIMENSION IN MM</p> <div style="text-align: center; margin-top: 10px;"> </div> <table border="1" style="width:100%; border-collapse: collapse; margin-top: 10px;"> <thead> <tr> <th>PKG INFO</th> <th>DRAWING NO.</th> </tr> </thead> <tbody> <tr> <td>4L PQFN 3.200x2.500x0.750 mm</td> <td>POD-002-PQFN-004-X03225</td> </tr> <tr> <td></td> <td>REV</td> </tr> <tr> <td>DATE 23 Sep 2021</td> <td>B00</td> </tr> </tbody> </table>		SYMBOL	MIN	NOM	MAX	TOTAL THICKNESS	A	0.700	0.750	0.800	STAND OFF	A1	0.000	0.020	0.050	BODY SIZE	X	D 3,200 BSC			Y	E 2,500 BSC			LEAD WIDTH	b	0.800	0.900	1.000	L	0.600	0.700	0.800	LEAD LENGTH	L1	0.700	0.800	0.900	LEAD PITCH	e	2,100 BSC			RADIUS	F	0.450 REF			F1	0.200 REF			PACKAGE TOLERANCE	aaa	0.050			MOLD FLATNESS	bbb	0.100			COPLANARITY	ccc	0.080			PKG INFO	DRAWING NO.	4L PQFN 3.200x2.500x0.750 mm	POD-002-PQFN-004-X03225		REV	DATE 23 Sep 2021	B00	
	SYMBOL	MIN	NOM	MAX																																																																								
TOTAL THICKNESS	A	0.700	0.750	0.800																																																																								
STAND OFF	A1	0.000	0.020	0.050																																																																								
BODY SIZE	X	D 3,200 BSC																																																																										
	Y	E 2,500 BSC																																																																										
LEAD WIDTH	b	0.800	0.900	1.000																																																																								
	L	0.600	0.700	0.800																																																																								
LEAD LENGTH	L1	0.700	0.800	0.900																																																																								
LEAD PITCH	e	2,100 BSC																																																																										
RADIUS	F	0.450 REF																																																																										
	F1	0.200 REF																																																																										
PACKAGE TOLERANCE	aaa	0.050																																																																										
MOLD FLATNESS	bbb	0.100																																																																										
COPLANARITY	ccc	0.080																																																																										
PKG INFO	DRAWING NO.																																																																											
4L PQFN 3.200x2.500x0.750 mm	POD-002-PQFN-004-X03225																																																																											
	REV																																																																											
DATE 23 Sep 2021	B00																																																																											

Notes:

- 14. Top marking: Y denotes manufacturing origin and XXXX denotes manufacturing lot number. The value of “Y” will depend on the assembly location of the device.
- 15. A capacitor of value 4.7 nF between XIN and GND is required.

Table 16. Additional Information

Document	Description	Download Link
Time Machine II	XCalibur programmer	www.sitime.com/time-machine-oscillator-and-active-resonator-programmer
Field Programmable Oscillators	Devices that can be programmable in the field by Time Machine II	www.sitime.com/support/resource-library/datasheets/field-programmable-oscillators-and-active-resonators-datasheet
Manufacturing Notes	Tape & Reel dimension, reflow profile and other manufacturing related info	www.sitime.com/support/resource-library/manufacturing-notes-sitime-products
Qualification Reports	RoHS report, reliability reports, composition reports	www.sitime.com/support/quality-and-reliability
Performance Reports	Additional performance data such as phase noise, current consumption and jitter for selected frequencies	www.sitime.com/support/performance-measurement-report
Termination Techniques	Termination design recommendations	www.sitime.com/support/application-notes
Layout Techniques	Layout recommendations	www.sitime.com/support/application-notes

Revision History

Table 17. Revision History

Revision	Release Date	Change Summary
0.1	30-Jul-2021	First draft
1.0	1-Dec-2021	Production release Added Application Note Rev 0.6 and FAQ sections
1.01	7-Apr-2022	Removed 2016 package option Removed T and Y options from the ordering code

SiTime Corporation, 5451 Patrick Henry Drive, Santa Clara, CA 95054, USA | Phone: +1-408-328-4400 | Fax: +1-408-328-4439

© SiTime Corporation 2021-2022. The information contained herein is subject to change at any time without notice. SiTime assumes no responsibility or liability for any loss, damage or defect of a Product which is caused in whole or in part by (i) use of any circuitry other than circuitry embodied in a SiTime product, (ii) misuse or abuse including static discharge, neglect or accident, (iii) unauthorized modification or repairs which have been soldered or altered during assembly and are not capable of being tested by SiTime under its normal test conditions, or (iv) improper installation, storage, handling, warehousing or transportation, or (v) being subjected to unusual physical, thermal, or electrical stress.

Disclaimer: SiTime makes no warranty of any kind, express or implied, with regard to this material, and specifically disclaims any and all express or implied warranties, either in fact or by operation of law, statutory or otherwise, including the implied warranties of merchantability and fitness for use or a particular purpose, and any implied warranty arising from course of dealing or usage of trade, as well as any common-law duties relating to accuracy or lack of negligence, with respect to this material, any SiTime product and any product documentation. Products sold by SiTime are not suitable or intended to be used in a life support application or component, to operate nuclear facilities, or in other mission critical applications where human life may be involved or at stake. All sales are made conditioned upon compliance with the critical uses policy set forth below.

CRITICAL USE EXCLUSION POLICY

BUYER AGREES NOT TO USE SITIME'S PRODUCTS FOR ANY APPLICATION OR IN ANY COMPONENTS USED IN LIFE SUPPORT DEVICES OR TO OPERATE NUCLEAR FACILITIES OR FOR USE IN OTHER MISSION-CRITICAL APPLICATIONS OR COMPONENTS WHERE HUMAN LIFE OR PROPERTY MAY BE AT STAKE.

SiTime owns all rights, title and interest to the intellectual property related to SiTime's products, including any software, firmware, copyright, patent, or trademark. The sale of SiTime products does not convey or imply any license under patent or other rights. SiTime retains the copyright and trademark rights in all documents, catalogs and plans supplied pursuant to or ancillary to the sale of products or services by SiTime. Unless otherwise agreed to in writing by SiTime, any reproduction, modification, translation, compilation, or representation of this material shall be strictly prohibited.

XCalibur Active MEMS Resonator MCU Requirements

1	Introduction.....	13
2	MCU Analog and Digital Operation Modes.....	14
3	MCU GPIO.....	15
3.1	Power Requirements (VDDIO).....	15
3.2	Current Requirements.....	15
3.3	Decoupling Cap Power Filter.....	15
4	MCU Programming Requirements.....	16
4.1	Microchip/Atmel ATSAME54P20.....	16
4.2	Texas Instruments MSP432P4111P.....	16
4.3	NXP S32K146.....	17
4.4	Renesas R7FS5D97.....	17
4.5	ST Micro STM32F303.....	18
5	Appendix A: MCU Compatibility List.....	19
6	Appendix B: Incompatible MCU List.....	20

1 Introduction

Embedded microcontroller (μ M/MCU) and micro-processor systems typically rely on an external quartz-based resonator for their operation. XCalibur active MEMS resonators are a drop-in replacement for 4-pin SMD resonators and offer a reliable, higher frequency stability alternative to quartz-based MHz [Figure 16](#).

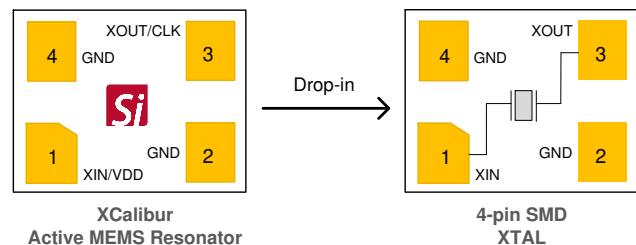

Figure 16. XCalibur Active MEMS Resonator Drop-In Compatible with 4-Pin SMD XTAL (TOP View)

The MCU system must meet the following conditions before XCalibur active MEMS resonators can be used as a drop-in replacement:

1. MCU can disable analog-mode for external crystal-resonator and bypass the MCU's internal Pierce oscillator circuit.
2. MCU can enable digital mode and drive GPIO to VDD to power up XCalibur XIN pin with ≥ 6 mA of current.
3. External pair of loading caps should be removed and a 4.7 nF decoupling cap to be placed on XIN for the GPIO power.

This application note provides details on the three requirements above to ensure a seamless drop-in transition to XCalibur resonators.

Example firmware is provided in Chapter 4: [MCU Programming Requirements](#) for a select number of MCUs where XCalibur resonators have been tested successfully. Sample firmware highlights required steps to switch from Analog Mode to Digital Mode to power up XCalibur.

[Appendix A](#) lists compatible MCUs that support XCalibur resonator requirements listed above.

A list of MCU that are **not** compliant with XCalibur resonator requirements are provided in [Appendix B](#).

2 MCU Analog and Digital Operation Modes

Quartz-based resonators rely on a Pierce oscillator inside an MCU to bias and drive the external resonator. XCalibur active resonators do not rely on a Pierce oscillator and only require power from the MCU's GPIO (X1 in [Figure 17](#)).

To meet this requirement, the MCU must disable the *Analog Mode* to bypass the Pierce oscillator (X1 and X2 pins), and then enable *Digital Mode* to provide GPIO power from X1 to XIN pin of the XCalibur resonator.

This analog to digital operating mode change is shown conceptually in [Figure 17](#).

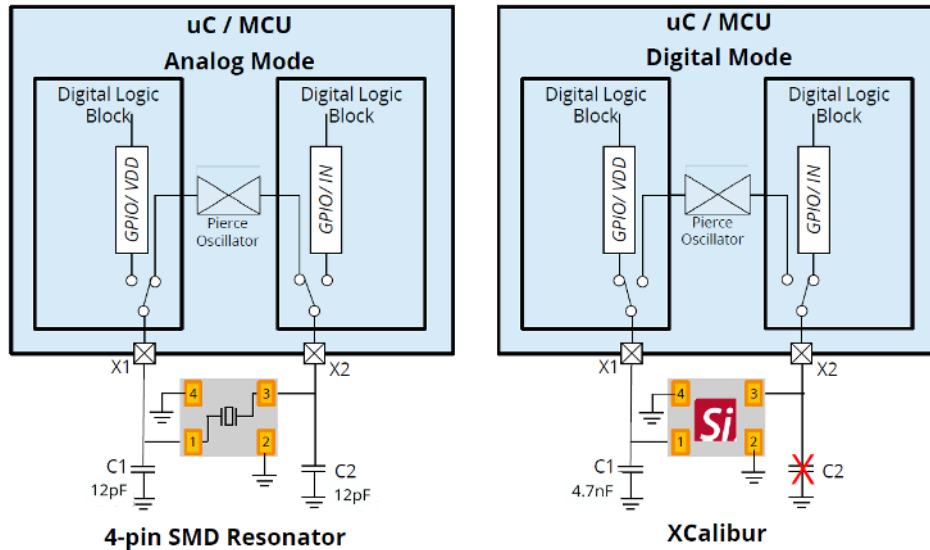

Figure 17. MCU in Analog Mode with Pierce Oscillator (left), and Digital Mode with GPIO Enabled (right)

Application Note

3 MCU GPIO

The XCalibur SiT14xx family of resonators require a power source from the MCU. This section outlines power requirements from the MCU and considerations to mitigate potential transient-currents that may be present during power-up and power-down events.

List of power requirements:

1. The MCU must provide power over GPIO in the range of 1.8 V to 3.3 V.
2. The GPIO must deliver 6mA or greater current
3. External crystal-resonator loading caps are removed, and a single decoupling cap of 4.7 nF is added on the VDD pin of the XCalibur resonator.
 - a. An MCU with on-chip loading caps should accommodate an external decoupling cap on the existing PCB.

3.1 Power Requirements (VDDIO)

Most MCU can provide a GPIO voltage (VDDIO) equal to the core-voltage VDD. Any voltage drop on the GPIO must be accounted and maintained within the operating specification range of XCalibur resonators.

3.2 Current Requirements

A minimum of 6 mA or greater current is required for normal operation across supported voltage supplies between 1.8 V to 3.3 V. Using a 4.7 nF decoupling cap is a requirement that will ensure stable power supply that will meet XCalibur requirement.

3.3 Decoupling Cap Power Filter

A 4.7 nF decoupling cap is required when using XCalibur resonators as a drop-in replacement. This capacitor replaces any loading capacitor C1 on X1 (XCalibur XIN) Pin. Any loading cap C2 on X2 must be removed.

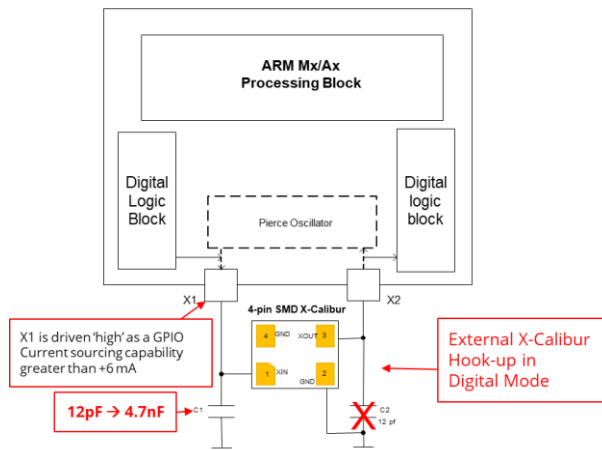

Figure 18. MCU De-Coupling Cap on GPIO

The decoupling cap minimizes power supply fluctuations and filters out power supply noise due to external influences. Adding a decoupling capacitor to a circuit introduces charge and discharge currents during power-up (rising edge) and power-down (falling edge) of the GPIO output (Figure 19).

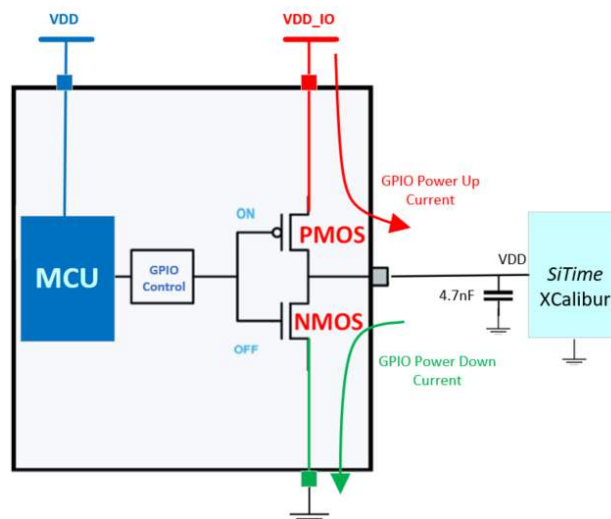

Figure 19. MCU Push-Pull Output Voltage and Current Path

4 MCU Programming Requirements

After reset, an MCU is brought up using an internal low-rate RC oscillator to manage basic H/W configuration and initialization of its I/O pins. This section gives examples code for a select number of MCUs to configure their GPIO for proper operation using XCalibur active MEMS resonator. Sample code is provided for the following MCU:

- Microchip/Atmel ATSAME54P20
- TI MSP432P4111P
- NXP S32K146
- Renesas R7FS5D97
- ST Micro STM32F303

Please [contact SiTime](#) for any support in programming different MCU.

4.1 Microchip/Atmel ATSAME54P20

The external oscillator operations are configured via OSCCTRL control registers. Through this interface, these oscillators are enabled, disabled, or have their calibration values updated.

The external Multipurpose Crystal Oscillator (XOSCn) can operate in two different modes:

- External clock, with an external clock signal connected to the XIN pin
- Crystal oscillator, with an external 8-48 MHz crystal connected to the XIN and XOUT pins

After a reset, the XOSCn is disabled and the XINn/XOUTn pins can be used as General Purpose I/O (GPIO) pins by other peripherals in the system.

When XOSCn is enabled, the operating mode determines the GPIO usage. The XINn and XOUTn pins are controlled by the OSCCTRL when in crystal oscillator mode, and GPIO functions are overridden on both pins.

Only the XINn pins will be overridden and controlled by the OSCCTRL when in external clock mode, while the XOUTn pins can still be used as GPIO pins.

The latter is the mode used by XCalibur resonators.

Table 18: Atmel ATSAM54P20 sample code for configuring XOUT as GPIO

```
OSCCTRL->XOSCCTRL[1].reg &= ~(1 << 2); // select external clock instead of crystal by //writing 0 to XTALLEN bit
PORT->Group[1].DIRSET.reg |= (1 << 23); // configure XOUT (PB23) as pin out
PORT->Group[1].OUTSET.reg |= (1 << 23); // set PB23 to high state
OSCCTRL->XOSCCTRL[1].reg |= (1 << 1); // enable OSC block by writing 1 to ENABLE bit

/* wait 5ms to ensure XCalibur starts */
/* select XOSC1 as a clock source for the system (e.g., for DPLL or GCG) */
```

4.2 Texas Instruments MSP432P4111P

TI MSP432P4111P device can support a high-frequency crystal on the HFXT pins.

It is possible to apply an Oscillator digital clock such as XCalibur to the LFXIN and HFXIN input pins when the appropriate LFXTBYPASS or HFXTBYPASS mode is selected.

In this case, the associated LFXOUT and HFXOUT pins can be used for other purposes. If they are left unused, they must be terminated.

XCalibur uses this HFXTBYPASS mode to use the HFXT pins in GPIO mode.

Table 19: TI MSP432 sample code to enable GPIO Mode

```
CS->KEY = 0x695A; // unlock clock system registers
CS->CTL2 &= ~(1 << 25) | ~(1 << 24) // Set HFXT for bypass mode
PJ->SEL0 = (PJ->SEL0 & 0xF3) | 0x08; // Set HFXIN to bypass mode
PJ->SEL1 = (PJ->SEL1 & 0xF3) | 0x00; // Set HFXOUT to GPIO mode
PJ->DIR |= (1 << 2); // set HFXOUT (PJ.3) to Out direction
PJ->OUT |= (1 << 2); // set PJ.3 to high state

/* wait 5ms to ensure XCalibur starts */
/* select HFX as a clock source for the system */

CS->KEY = 0; // lock clock system registers
```

Application Note

4.3 NXP S32K146

NXP S32K1XX is a low-power ARM Cortex-M4F/M0+ core micro-controller.

Clocking options for the NXP processor are:

- 4 to 40 MHz fast external oscillator (SOSC) or 50 MHz DC external square input clock in external clock mode
- 48 MHz Fast Internal RC oscillator (FIRC)
- MHz Slow Internal RC oscillator (SIRC)

- 128 kHz Low Power Oscillator (LPO)
- Up to 112 MHz (HSRUN) System Phased Lock Loop (SPLL)
- Up to 20 MHz TCLK and 25 MHz SWD_CLK
- 32 kHz Real Time Counter external clock (RTC_CLKIN)

XCalibur uses “SOSC” external oscillator mode using the following configuration.

Table 20: NXP S32K146 SOSC external clock mode configuration firmware

```
SCG->SOSCCFG &= ~(1 << 2);           // configure SOSCCFG External reference clock

PCC-> PCCn[0x128] |= (1<<30);         // Enable clock on PORT B
PORTB->PCR[6] |= (PORTB->PCR[6] & 0xFFFFF8BF)|(1<<8)|(1<<6);
// Configure XTAL (PB6) pins to GPIO with high drive strength

PTB->PDDR |= 1 << 6;                 // set XTAL pin(PB6) to out direction
PTB-> PSOR |= 1 << 6;                 // set PB6 to high state

/* wait 5ms to ensure XCalibur starts */
/* select OSC as a clock source for the system */
```

4.4 Renesas R7FS5D97

The Renesas MCU supports an external oscillator by configuring XTAL as a CMOS GPIO Output and EXTAL as the clock input.

XCalibur clock output is connected to EXTAL input of the MCU.

Table 21: Renesas R7FS5D97 MCU EXTAL/XTAL clock mode configuration firmware

```
R_SYSTEM->PRCR = 0xA501;              // Enables writing to the registers related to the Clock
                                     // Generation Circuit

R_PFS->P213PFS = 0xC00;              // set XTAL pin function as CMOS with hi-drive capability

R_IOPORT2->PCNTR1 |= (1 << 29) | (1 << 13) // Configure XTAL pin (P213) to out direction
                                     // with high state

R_SYSTEM->MOSCCR_b.MOSTP = 0x01;     // stop main oscillator
R_SYSTEM->MOMCR_b.MOSEL = 0x01;     // Configure Main Clock to external clock input
R_SYSTEM->MOSCCR_b.MOSTP = 0;        // enable main oscillator

R_SYSTEM->PRCR = 0x0;                // Disable writing to the registers related to the Clock
                                     // Generation Circuit

/* wait 5ms to ensure XCalibur starts */
/* select Main clock oscillator as a clock source for the system */
```

4.5 ST Micro STM32F303

```
RCC->CR |= (1 << 18) | (1 << 16);      // Configure external clock

RCC->AHBENR |= (1 << 22);                // enable clock on PORT F
GPIOF->MODER |= (GPIOF->MODER & 0xFFFFFFF3) | 0x04; // set PF1 (XOSC_OUT) pin function as
                                                GPIO
GPIOF->OTYPER &= ~(1 << 1);              // select output type as push-pull
GPIOF->OSPEEDR |= (1 << 3) | (1 << 2);    // select hi-drive capability
GPIOF->BSRR |= (1 << 1);                 // set PF1 to high state

/* wait 5ms to ensure XCalibur starts */
/* select Main clock oscillator as a clock source for the system */
```

5 Appendix A: MCU Compatibility List

The following compatibility list has been compiled based on information obtained from each MCU's datasheet. Please contact the [SiTime support team](#) for the latest update to this list.

**Table 22: XCalibur MCU Compatibility
(Based on Datasheet)**

Manufacturer	MCU Type	MCU Series	MCU PN	XCalibur Compliant Based on Datasheet (with Sample Code *)
ST-Micro	ARM	STM32F	STM32F303RET6	Yes*
ST-Micro	ARM	STM32G STM32G0	STM32G081xB STM32G474xB	Yes
ST-Micro	ARM	STM32H	STM32H742xI/G	Yes
ST-Micro	ARM	STM32L0 STM32L1 STM32L4 STM32L4+ STM32L5	STM32L010RB STM32L151xE STM32L471xx STM32L4R5xx STM32L562xx	Yes
ST-Micro	ARM	STM32U	STM32U585xx	Yes
Microchip (Atmel)	ARM	ATSAME54	ATSAME54P20	Yes*
TI	ARM	MSP432	MSP432P4111P	Yes*
Renesas	ARM	S5D9	R7FS5D97E3A01CFC	Yes*
NXP	ARM	S32K1xx	S32K146	Yes*
Infineon (Cypress)	ARM	PSoc4-BLE	CY8C4248LQI-BL583	Yes
Microchip	CISC	PIC18	PIC18LF46K22T-I/ML	Yes

6 Appendix B: Incompatible MCU List

The following MCUs are not compatible as a drop-in replacement for XCalibur resonators. Please contact the [SiTime support team](#) for the latest update to this list.

**Table 23: Incompatible MCU List
(Based on Datasheet)**

Manufacturer	Grade	MCU Series	MCU PN	XCalibur Compliant
ST-Micro	Commercial	STM32WB STM32WL		No
ST-Micro	Auto	SPC5	SPC58EC80E5	No
Infineon	Auto	TC3xx(Aurix)	SAK-TC375TP-96F300W	No
Infineon	Industrial	XMC4000		No
TI	Auto	CC2642R-Q1	CC2652R1FRGZ	No
Renesas	Commercial	RL78/G13	R5F100LEAFB	No
NXP	Commercial	LPC11U68	LPC11U68JBD100	No
NXP	Auto	S32G	S32G2	No
Cypress	Auto	PSOC4-BLE	CY8C4248LQI-BL583	No
SiLabs	Commercial	EFM32G	EFM32G890F128	No
Renesas	Automotive	RH-850/D1L2	R7F701422	No

XCalibur Active MEMS Resonator Frequently Asked Questions

1 Introduction

This section provides a list of frequently asked questions (FAQs) when replacing a 4-pin XTAL resonator with an SiT14xx XCalibur™ active MEMS resonator from SiTime. This FAQ should be used as a companion to application note [AN-10080 SiT14xx XCalibur Active MEMS Resonator MCU Requirements](#).

2 General Hardware

- How does the footprint of a SiT14xx active resonator compare to a 4-pin SMD XTAL resonator?
 - [Figure 20](#) shows a comparison of the XCalibur footprint compared to a 4-pin resonator.

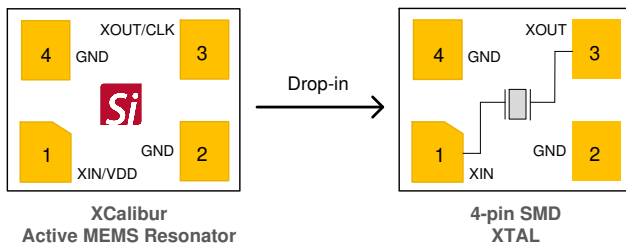

Figure 20. XCalibur Active MEMS Resonator compared with 4-Pin SMD XTAL (TOP View)

- What is an active MEMS resonator?
 - An active resonator is a resonator based on micro-electro mechanical systems (MEMS) technology that will need a power source to generate an output.
- What are the available packages for SiT14xx active resonators?
 - Industry-standard 3225 and 2520 SMD packages.
- Can I replace a 2-pin crystal resonator with 4-pin XCalibur resonator?
 - No. The 2-pin PCB landing pads needs to be re-designed for the 4-pin footprint of SiT14xx.
- The X1/X2 pins or XIN/XOUT functions are swapped on my MCU. Can I use XCalibur in this scenario?
 - Yes. You can rotate the package 180 degrees so that pins 1 and 3 and 2 and 4 are swapped on the landing pads such that the XIN/XOUT functions are mated correctly with the MCU.
- What is analog mode in an MCU?
 - Analog mode refers to the mode that enables an internal Pierce oscillator that supports an external XTAL-Resonator.
- What is digital mode in an MCU?
 - Digital mode refers to a mode of operation in an MCU that uses an external oscillator. When in digital mode, the MCU also enables XIN as a GPIO and can provide power to GPIO.

3 Software

- Is there any firmware change required after replacing a XTAL resonator?
 - Yes. A firmware change is required to enable GPIO to provide power and to setup the MCU to operate from an external oscillator.

4 Electrical

- What power supplies are supported?
 - SiT14xx supports two supplies:
 - 1.8 V fixed
 - 2.25 V to 3.63 V variable
- What is the current requirement for XCalibur?
 - SiT14xx requires a minimum 6 mA of current (includes 2 mA of margin above steady state).
- Do I need to replace the 12 pF loading capacitors used in a 4-pin XTAL SMD design?
 - Yes. The loading capacitor on X1/XIN must be replaced with a 4.7 nF cap.
 - The loading cap on X2/XOUT must be removed.
- Why is a 4.7 nF capacitor used on XIN?
 - A 4.7 nF decoupling cap is used to filter noise on GPIO power for better performance.
- My MCU cannot provide power (as GPIO) over X1/XIN. Can I still use XCalibur?
 - Yes, if you can provide an alternative source of power to SiT14xx.
- Can I use a larger (47 nF) decoupling capacitor instead of recommended 4.7 nF value?
 - No. A 4.7 nF decoupling cap is sufficient and a larger value capacitor is not recommended.
 - The decoupling cap minimizes power supply fluctuations and filters out power supply noise due to external influences. Adding a decoupling capacitor to a circuit introduces a charge and a discharge current during power-up (rising edge) and power-down (falling edge) of the GPIO output ([Figure 19](#)).
 - A larger 47 nF (instead of 4.7 nF) capacitor will increase this current on power-up and power-down.

5 Limitations FAQ

- Can an XCalibur active resonator be used with any MCU?
 - No. Please refer to [XCalibur MCU Compatibility](#) and [Incompatible MCU List](#).

Supplemental Information

The Supplemental Information section is not part of the datasheet and is for informational purposes only.

Best Reliability

Silicon is inherently more reliable than quartz. Unlike quartz suppliers, SiTime has in-house MEMS and analog CMOS expertise, which allows SiTime to develop the most reliable products. Figure 1 shows a comparison with quartz technology.

Why is SiTime Best in Class:

- SiTime’s MEMS resonators are vacuum sealed using an advanced EpiSeal® process, which eliminates foreign particles and improves long term aging and reliability
- World-class MEMS and CMOS design expertise

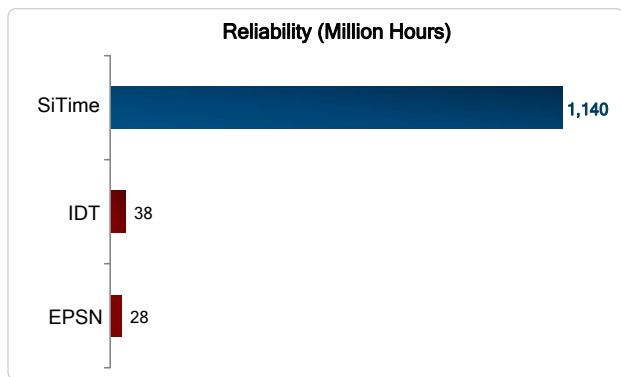

Figure 1. Reliability Comparison^[1]

Best Aging

Unlike quartz, MEMS oscillators have excellent long term aging performance which is why every new SiTime product specifies 10-year aging. A comparison is shown in Figure 2.

Why is SiTime Best in Class:

- SiTime’s MEMS resonators are vacuum sealed using an advanced EpiSeal® process, which eliminates foreign particles and improves long term aging and reliability
- Inherently better immunity of electrostatically driven MEMS resonator

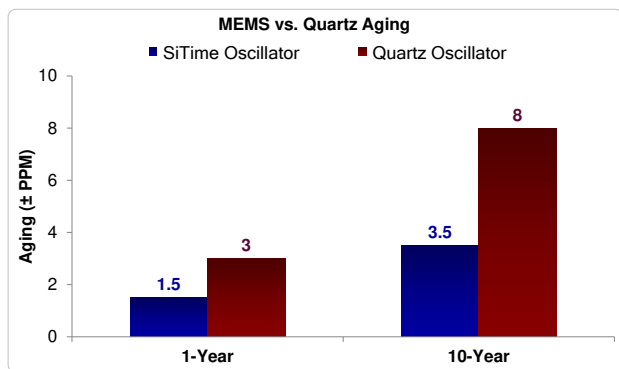

Figure 2. Aging Comparison^[2]

Best Electro Magnetic Susceptibility (EMS)

SiTime’s oscillators in plastic packages are up to 54 times more immune to external electromagnetic fields than quartz oscillators as shown in Figure 3.

Why is SiTime Best in Class:

- Internal differential architecture for best common mode noise rejection
- Electrostatically driven MEMS resonator is more immune to EMS

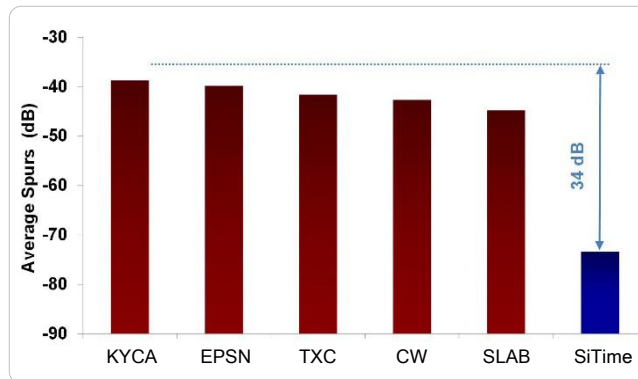

Figure 3. Electro Magnetic Susceptibility (EMS)^[3]

Best Power Supply Noise Rejection

SiTime’s MEMS oscillators are more resilient against noise on the power supply. A comparison is shown in Figure 4.

Why is SiTime Best in Class:

- On-chip regulators and internal differential architecture for common mode noise rejection
- MEMS resonator is paired with advanced analog CMOS IC

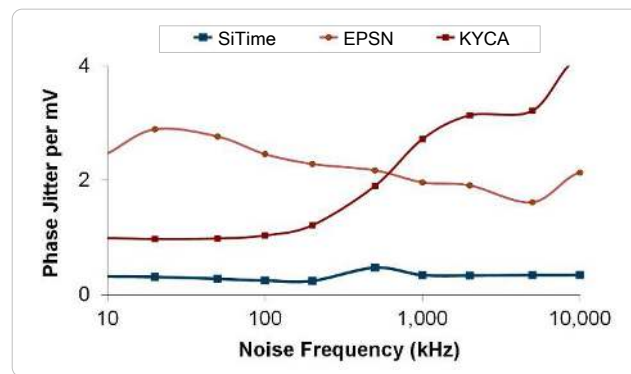

Figure 4. Power Supply Noise Rejection^[4]

Best Vibration Robustness

High-vibration environments are all around us. All electronics, from handheld devices to enterprise servers and storage systems are subject to vibration. Figure 5 shows a comparison of vibration robustness.

Why is SiTime Best in Class:

- The moving mass of SiTime’s MEMS resonators is up to 3000 times smaller than quartz
- Center-anchored MEMS resonator is the most robust design

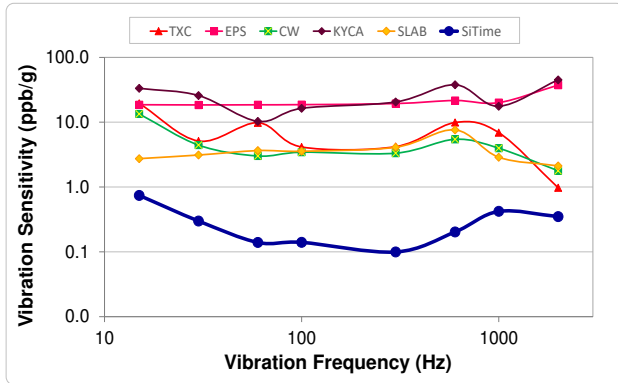

Figure 5. Vibration Robustness^[5]

Figure labels:

- TXC = TXC
- Epson = EPSN
- Connor Winfield = CW
- Kyocera = KYCA
- SiLabs = SLAB
- SiTime = EpiSeal MEMS

Best Shock Robustness

SiTime’s oscillators can withstand at least 50,000 g shock. They all maintain their electrical performance in operation during shock events. A comparison with quartz devices is shown in Figure 6.

Why is SiTime Best in Class:

- The moving mass of SiTime’s MEMS resonators is up to 3000 times smaller than quartz
- Center-anchored MEMS resonator is the most robust design

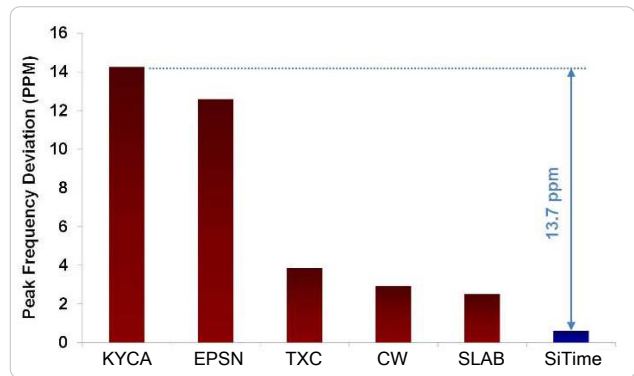

Figure 6. Shock Robustness^[6]

Notes:

1. Data source: Reliability documents of named companies.
2. Data source: SiTime and quartz oscillator devices datasheets.
3. Test conditions for Electro Magnetic Susceptibility (EMS):

- According to IEC EN61000-4.3 (Electromagnetic compatibility standard)
- Field strength: 3V/m
- Radiated signal modulation: AM 1 kHz at 80% depth
- Carrier frequency scan: 80 MHz – 1 GHz in 1% steps
- Antenna polarization: Vertical
- DUT position: Center aligned to antenna

Devices used in this test:

Label	Manufacturer	Part Number	Technology
EpiSeal MEMS	SiTime	SiT9120AC-1D2-33E156.250000	MEMS + PLL
EPSN	Epson	EG-2102CA156.2500M-PHPAL3	Quartz, SAW
TXC	TXC	BB-156.250MBE-T	Quartz, 3 rd Overtone
CW	Conner Winfield	P123-156.25M	Quartz, 3 rd Overtone
KYCA	AVX Kyocera	KC7050T156.250P30E00	Quartz, SAW
SLAB	SiLab	590AB-BDG	Quartz, 3 rd Overtone + PLL

4. 50 mV pk-pk Sinusoidal voltage.

Devices used in this test:

Label	Manufacturer	Part Number	Technology
EpiSeal MEMS	SiTime	SiT8208AI-33-33E-25.000000	MEMS + PLL
NDK	NDK	NZ2523SB-25.6M	Quartz
KYCA	AVX Kyocera	KC2016B25M0C1GE00	Quartz
EPSN	Epson	SG-310SCF-25M0-MB3	Quartz

5. Devices used in this test:

same as EMS test stated in Note 3.

6. Test conditions for shock test:

- MIL-STD-883F Method 2002
- Condition A: half sine wave shock pulse, 500-g, 1ms
- Continuous frequency measurement in 100 μ s gate time for 10 seconds

Devices used in this test:

same as EMS test stated in Note 3.

- 7. Additional data, including setup and detailed results, is available upon request to qualified customer. Please contact productsupport@sitime.com.